

**DESIGN, DEVELOPMENT AND ANALYSIS
BY BOND GRAPH SIMULATION
TECHNIQUE FOR COMFORT RIDE ON
VEHICLES**

**A Thesis Submitted
in Partial Fulfillment of the Requirements
for the Degree of**

**DOCTOR OF PHILOSOPHY
in
MECHANICAL ENGINEERING**

by

**Manoj Kumar Singh
(Enrollment No. 13ME1715)**

**Under the Supervision of
Prof. (Dr.) Bharat Raj Singh
School of Management Sciences, Lucknow**



**to the
Faculty of Mechanical Engineering**

**Dr. APJ ABDUL KALAM TECHNICAL UNIVERSITY
LUCKNOW
(Formerly Uttar Pradesh Technical University, Lucknow)
December, 2024**

DECLARATION

I hereby declare that the work presented in this report entitled “**Design, Development and Analysis by Bond Graph Simulation Technique for Comfort Ride on Vehicles**” was carried out by me. I have not submitted the matter embodied in this report for the award of any other degree or diploma of any other University or Institute.

I have given due credit to the original authors/sources for all the words, ideas, diagrams, graphics, computer programs, experiments, results, that are not my original contribution. I have used quotation marks to identify verbatim sentences and given credit to the original authors/sources.

I affirm that no portion of my work is plagiarized, and the experiments and results reported in the report are not manipulated. In the event of a complaint of plagiarism and the manipulation of the experiments and results, I shall be fully responsible and answerable.

Name: Manoj Kumar Singh

Enroll. No. :13ME1715

Field: Mechanical Engineering

(Signature of Research Scholar)

CERTIFICATE

Certified that Mr. **Manoj Kumar Singh** (enrollment no 13ME1715) has carried out the research work presented in this thesis entitled “**Design, Development and Analysis by Bond Graph Simulation Technique for Comfort Ride on Vehicles**” for the award of **Doctor of Philosophy** from Dr. APJ Abdul Kalam Technical University, Lucknow under my supervision. The thesis embodies result of original work, and studies carried out by Student himself and the contents of the thesis do not form the basis for the award of any other degree to the candidate or to anybody else from this or any other University.

It is also certified that scholar has incorporated all the comments by evaluators (Indian and foreigner) at appropriate places in proper order.

Prof. (Dr.) Bharat Raj Singh

Supervisor,

School of Management Science,

Lucknow- 226501, UP, India.

Date: December 2024

DESIGN, DEVELOPMENT AND ANALYSIS BY BOND GRAPH SIMULATION TECHNIQUE FOR COMFORT RIDE ON VEHICLES

Manoj Kumar Singh

ABSTRACT

Despite the challenges posed by the energy crisis, population growth, and environmental degradation, there has been a persistent rise in the use of automobiles. This underscores the need to redouble efforts in creating vehicles that are more efficient, environmentally friendly, safer, and easier to control. This frequently involves the enhancement of existing models and the increased integration of onboard computers. Employing computers for control necessitates the creation of models that operate swiftly and reliably, even in extreme conditions. Techniques based on bond graphs facilitate the development of continuously adaptable models and streamline their integration with control systems.

The present work deals with the development of the so called full car models using Bond graph based approaches to study the response of the vehicle while passing over a ramp or uneven surface.

The first model has been evolved using a fairly standard suspension system attached between the wheels and the body of the vehicle. The results obtained through the model have been compared with results obtained elsewhere. The results match very well showing that the model is correctly formulated and the software package employed is being properly used. Model has been run to obtain some additional results as well. The second deals with the extension of the first model into a more complex hinged arm suspension with additional springs and dashpots, some of it may be replaced by active control elements. A successful compilation of the Bond graph on the Bond graph package Symbol Shakti shows that the model has been created with logical correctness. More extensive validation may be needed before it can be taken up for testing its utility for online control etc.

It is known facts that operating high-speed vehicles efficiently on rural roads presents a unique set of challenges, distinct from those encountered on national highways, expressways, and super expressways. It is crucial to recognize the varied costs, impacts on vehicle lifespan, and comfort levels associated with these diverse terrains. This issue highlights a noticeable research gap concerning the design and development of vehicles explicitly tailored for rural and district roads in India. Considering India's position with the world's second-largest road network, spanning 6.2 million km and surpassing most nations, except the United States with a network of 6.8 million km, addressing this research gap becomes significantly important.

Addressing the unique challenges posed by rural terrains requires a focused exploration of economic considerations, vehicle durability, and passenger comfort. The outcomes of such research have the potential to guide the design and implementation of vehicles that not only withstand the demands of rural roads but also contribute to the overall enhancement of India's extensive road network and economy. The present research endeavors to shape the future of transportation in India, specifically for rural and district roads, ensuring efficiency while catering to the specific needs of diverse landscapes.

In the context of rural road conditions, where road geometry is characterized by bumps and potholes up to 100mm (0.100m) in sprung-mass displacement, the design criteria for rural road vehicles include a tyre damping coefficient of ≥ 4 kNs/m, capable of achieving speeds of ≤ 75 km/h. It is observed that as the damping coefficient increases, the sprung-mass displacement decreases. A suspension damping coefficient of ≤ 8 kNs/m results in higher sprung-mass displacement, allowing for vehicle speeds above 50 km/h but not exceeding 75 km/h.

Thus, this research is pivotal in the development of cost-effective and environmentally friendly vehicles tailored for rural roads, especially in India, a country that takes pride in its robust economy, once focused on designing and creating transport vehicles specifically for the rural sector.

ACKNOWLEDGEMENTS

The author wishes to convey profound gratitude and respect to the Supervisor, Professor (Dr.) Bharat Raj Singh, Director General (Technical) at the School of Management Science, Lucknow, for consistently providing encouragement and support.

Special appreciation and thanks are extended to Shri Anand Shekhar Singh, Chairman of the Babu Sunder Singh Group of Institutions, and Mrs. Rina Singh, Vice Chairperson of the same institution in Lucknow. Their unwavering support has been instrumental, directly and indirectly, in the completion of the present work.

The author is indebted to Mrs. Malti Singh, the wife of the supervisor, Mrs. Nidhi Singh, the supervisor's daughter, Mr. Saurabh Singh and Mr. Gaurav Singh, the supervisor's sons, as well as the author's parents, his in-laws, Mrs. Sabita Singh, his wife and Ms Kasturi his daughter. Their moral support has been invaluable, playing a pivotal role in shaping this thesis.

A heartfelt thanks is extended to Prof. (Dr.) Amalendu Mukherjee, Professor in the Mechanical Engineering Department at the Indian Institute of Technology Kharagpur, for consistently believing in the author's dedication to a meaningful pursuit.

The author also extends thanks to Shri Sharad Singh, CEO of the School of Management Sciences, Lucknow, for the encouragement and support..

Manoj Kumar Singh
Research Scholar

TABLE OF CONTENTS

S.NO.	DETAILS	PAGE NOS.
	Declaration	ii
	Certificate	iii
	Abstract	iv
	Acknowledgements	vi
	Table of Contents	vii
	List of Tables	xxix
	List of Figures	xxx
	Nomenclature	xxxv
	Abbreviations	xxxvii
CHAPTER1	INTRODUCTION	1-40
1.1	BRIEF OVERVIEW OF THE MAIN SALIENT FEATURES INFLUENCING RIDE COMFORT	2
1.1.1	Suspension System Design	2
	<i>1.1.1.1 Challenges and Advances in Suspension System Design</i>	3
1.1.2	Damping Characteristics and Importance	3
1.1.3	Tyre Characteristics, Ride Quality and Technology	4
	<i>1.1.3.1 Impact of Tyre Characteristics on Ride Quality</i>	5
	<i>1.1.3.2 Advances in Tyre Technology</i>	5
1.1.4	Vehicle Mass and Inertia: Understanding, Trade off and Balancing	6
	<i>1.1.4.1 Stability and Inertia</i>	6
	<i>1.1.4.2 Trade-offs Between Mass,</i>	7

	<i>Inertia, and Fuel Efficiency</i>	
	<i>1.1.4.3 Balancing Mass and Inertia for Optimal Ride Comfort</i>	7
1.1.5	Road Surface Interaction	8
	<i>1.1.5.1 Smooth vs. Rough Surfaces:Smooth</i>	8
	<i>1.1.5.2 Impact on Ride Quality and Vehicle Dynamics</i>	8
	<i>1.1.5.3 Considerations for Road Surface Improvement</i>	9
1.1.6	Passenger Compartment Ergonomics	10
	<i>1.1.6.1 Seat Design and Ergonomics</i>	10
	<i>1.1.6.2 Considerations for Seat Cushioning and Layout</i>	10
	<i>1.1.6.3 Advances in Passenger Compartment Ergonomics</i>	11
1.1.7	Environmental Factors impacting Ride Comfort	12
	<i>1.1.7.1 Ride comfort in vehicles</i>	12
	<i>1.1.7.2 Road Conditions</i>	12
	<i>1.1.7.3 Weather Conditions and their Impact on Ride Comfort</i>	12
	<i>1.1.7.4 Noise Pollution and the Role of Environmental</i>	12
1.2	THE PURPOSE AND STRUCTURE OF THE COMFORTABLE RIDE OF TRANSPORT VEHICLES" STUDY	14
1.3	FACTORS INFLUENCING RIDE COMFORT	14
	1.3.1 Suspension Systems	14
	<i>1.3.1.1 Components of a Suspension System</i>	14
	1.3.2 Design Considerations	14

1.4	DAMPING AND SHOCK ABSORPTION TECHNOLOGIES	15
	1.4.1. Conventional Shock Absorbers	15
	1.4.2. Gas-Charged Shock Absorbers	15
	1.4.3. Twin-Tube vs. Mono-Tube Shock Absorbers	16
	1.4.4. Electronic Adaptive Damping	16
	1.4.5. Air Suspension Systems	16
	1.4.6. Semi-Active and Active Suspension	16
	<i>1.4.6.1 Porsche Active Suspension Management (PASM)</i>	16
	<i>1.4.6.2 Tesla Model S Air Suspension</i>	16
1.5	TYRE CHARACTERISTICS AND IMPACT ON COMFORT	17
	1.5.1. Tyre Size and Aspect Ratio	17
	1.5.2. Tyre Tread Pattern	17
	1.5.3. Tyre Compound and Construction	17
	1.5.4. Tyre Pressure	17
	1.5.5. Run-Flat Tyres	18
	1.5.6. Noise Reduction Technology	18
	1.5.7. Comfort-Oriented Tyres	18
1.6	VEHICLE DYNAMICS AND INERTIA EFFECTS	18
	1.6.1. Inertia and Acceleration	18

1.6.2. Inertia and Braking	18
1.6.3. Cornering and Centripetal Force	19
1.6.4. Roll and Pitch	19
1.6.5. Steering Response	19
1.6.6. Impact on Fuel Efficiency	19
1.7 ROAD SURFACE INTERACTION AND PAVEMENT QUALITY	19
1.7.1. Pavement Quality and Ride Comfort	20
1.7.2. Traction and Handling	20
1.7.3. Pavement Defects and Suspension Stress	20
1.7.4. Noise and Vibration Levels	20
1.7.5. Road Surface Material and Tyre Wear	20
1.7.6. Effect on Fuel Efficiency	20
1.7.7. Safety Considerations	21
1.8 INTERIOR LAYOUT, SEATING, AND ERGONOMICS	21
1.8.1. Seat Arrangement and Configuration	21
1.8.2. Ergonomic Design	21

1.8.3. Driver's Cockpit	21
1.8.4. Seating Comfort and Adjustability	22
1.8.5. Material Selection	22
1.8.6. Storage and Convenience Features	22
1.8.7. User Interface and Infotainment	22
1.8.8. Safety Considerations	22
1.9 NOISE, VIBRATION AND HARSHNESS (NVH) CONSIDERATIONS	22
1.9.1. Noise Control	22
1.9.2. Vibration Damping	23
1.9.3. Harshness Reduction	23
1.9.4. Aerodynamic Noise Control	23
1.9.5. Engine and Power Train Refinement	23
1.9.6. Material Selection	23
1.9.7. Suspension Tuning	24
1.9.8. Component Isolation	24
1.9.9. NVH Testing and Analysis	24
1.10 CLIMATE CONTROL AND VENTILATION SYSTEMS	24
1.10.1 Road Conditions	24
1.10.2 Weather Conditions and their Impact on Ride Comfort	25

1.10.2.1	<i>Weather Conditions</i>	25
1.10.2.2	<i>Temperature and Climate</i>	25
1.10.2.3	<i>Urban Environments</i>	25
1.10.2.4	<i>Environmental Sustainability</i>	25
1.11	ADVANCED SUSPENSION SYSTEMS AND ACTIVE DAMPING TECHNOLOGIES	26
1.11.1	Evolution from Passive to Active	26
1.11.2	Key Features and Components of Advanced Suspension Systems	26
1.11.2.1	<i>Adaptive Damping</i>	26
1.11.2.2	<i>Air Suspension</i>	26
1.11.3	Innovations in Active Damping Technologies	26
1.11.3.1	<i>Magnetic Ride Control</i>	26
1.11.3.2	<i>Electronically Controlled Dampers</i>	27
1.11.4	Benefits of Advanced Suspension Systems	27
1.11.4.1	<i>Improved Ride Comfort</i>	27
1.11.4.2	<i>Enhanced Handling and Stability</i>	27
1.11.5	Applications and Industry Trends	27
1.11.5.1	<i>Performance and Sports Cars</i>	27
1.11.5.2	<i>Off-Road Vehicles and SUVs</i>	27
1.11.6	Future Prospects and Conclusion	27
1.11.6.1	<i>Autonomous Vehicles</i>	27

1.12	SMART TYRE TECHNOLOGIES AND ADAPTIVE TYRE PRESSURE SYSTEMS	28
	1.12.1 Smart Tyre Technologies	28
	<i>1.12.1.1 Tyre Pressure Monitoring System (TPMS)</i>	28
	<i>1.12.1.2 Integration with Android Phone</i>	28
	1.12.2 Adaptive Tyre Pressure Systems and Conclusion	29
	<i>1.12.2.1 Color-Coded Indications and Notifications</i>	29
	<i>1.12.2.2 Benefits and Conclusion</i>	29
1.13	VEHICLE DYNAMICS CONTROL SYSTEMS FOR ENHANCED COMFORT	30
	1.13.1 Evolution of Vehicle Dynamics Control	30
	1.13.2 Categorization of Vehicle Dynamics Control Systems	30
	<i>1.13.2.1 Brake Systems</i>	30
	<i>1.13.2.2 Steering Systems</i>	30
	1.13.3 Advancements in Suspension Systems and x-by-wire Technologies	30
	<i>1.13.3.1 Suspension Systems</i>	30
	<i>1.13.3.2 X-by-wire Technologies</i>	30
	<i>1.13.3.3 Role of the Automotive Systems Group</i>	31
1.14	VEHICLE DYNAMICS SOFTWARES, TECHNOLOGICAL INNOVATIONS AND ITS ADVANCEMENTS	32
	1.14.1 Symbol Shakti Software	32

1.14.2	Enport Software	33
1.14.3	Archer Software	33
1.14.4	Camp-G Software	34
1.14.5	20 Sim Software	34
1.14.6	Pasion 32 Software	35
1.14.7	Bondlab Software	35
1.14.8	Cambas Software	36
1.14.9	Dymola Software	36
1.14.10	Hybridsim Software	37
1.14.11	Modelica Software	37
1.15	TECHNOLOGICAL INNOVATIONS IN VEHICLE DYNAMICS SOFTWARE	38
1.15.1	Real-Time Simulation	38
1.15.2	Integration of Artificial Intelligence (AI)	38
1.15.3	Multi-Physics Simulations	38
1.16	ADVANCEMENTS IN VEHICLE DYNAMICS SOFTWARE AND FUTURE TRENDS	38
1.16.1	Autonomous Vehicle Development	38

	1.16.2 Cloud-Based Simulation	39
	1.16.3 Cyber security Integration	39
	1.16.4 Human-Centric Design	39
CHAPTER 2	LITERATURE REVIEW	41-69
2.1	HISTORICAL PERSPECTIVE ON COMFORT RIDE IN TRANSPORT VEHICLES	41
2.2	THE CONCEPT OF RIDE COMFORT IN TRANSPORT VEHICLES IN EARLY YEARS	42
2.2.1	Early Transportation Modes (17th - 19th Century)	42
	<i>2.2.1.1 Horse-Drawn Carriages</i>	42
2.2.2	Rail Travel (Early 19th Century)	42
	<i>2.2.2.1 Steam Trains</i>	42
2.2.3	Automobiles (Late 19th - Early 20th Century)	42
	<i>2.2.3.1 Early Cars</i>	42
2.2.4	Advancements in Suspension Systems (Early to Mid-20th Century)	42
	<i>2.2.4.1 Leaf Springs and Shock Absorber</i>	42
2.2.5	Post-WWII Era (Mid-20th Century)	42
	<i>2.2.5.1 Advancements in Materials</i>	42
2.2.6	Air Travel (Mid-20th Century)	42
	<i>2.2.6.1 Jet Aircraft</i>	42
2.2.7	Focus on Ergonomics and Comfort (Late 20th Century)	43
	<i>2.2.7.1 Ergonomic Design</i>	43
2.2.8	Electronic Controls and Active Suspension (Late 20th - Early 21st	43

Century)	
2.2.8.1 <i>Electronic Controls</i>	43
2.2.8.2 <i>Active Suspension Systems</i>	43
2.2.9 Emergence of Autonomous Vehicles and AI (21st Century)	43
2.2.9.1 <i>Autonomous Vehicles</i>	43
2.2.10 Sustainability and Comfort (21st Century)	43
2.2.10.1 <i>Environmental Considerations</i>	43
2.3 PREVIOUS STUDIES AND RESEARCH FINDINGS ON MODELING OF SIMPLE CAR	43
2.4 MODELING OF FULL CAR WITH SIMPLE SPRING DASHPOT SUSPENSION AND HINGED SUSPENSION	47
2.5 ANALYSIS AND DESIGN OF VEHICLES CONSIDERING VIBRATIONS AND COST	55
2.6 NOTABLE TECHNOLOGICAL ADVANCEMENTS IN ENHANCING RIDE COMFORT	59
2.7 CURRENT INDUSTRY STANDARDS AND BEST PRACTICES OF COMFORT RIDE OF VEHICLES	62
2.8 NOISE REDUCTION AND VIBRATION DAMPING SOLUTIONS	63
2.8.1 Challenges in Lightweight Vehicle	63

Design	
2.8.2 Innovative Solutions in Green City Car Project	63
2.8.2.1 <i>Shunted Piezoelectric Patches</i>	63
2.8.2.2 <i>Electromagnetic Actuation</i>	64
2.8.2.3 <i>Smart Helmholtz Resonators</i>	64
2.8.3 Active Noise Control Systems and Damping Materials	64
2.8.3.1 <i>Active Noise Control Systems</i>	64
2.8.3.2 <i>Damping Materials and Acoustic Treatments</i>	64
2.8.3.3 <i>Project Goals and Progress</i>	64
2.9 INNOVATIVE INTERIOR MATERIALS AND DESIGN	65
2.9.1 Consumer Expectations	65
2.9.2 Technological Advancements in Interior Materials	65
2.9.2.1 <i>Advanced Materials for Enhanced Comfort</i>	65
2.9.2.2 <i>Smart Fabrics and Surfaces</i>	65
2.9.3 Sustainable Materials and Environmental Considerations	66
2.9.3.1 <i>Sustainable Interior Materials</i>	66
2.9.3.2 <i>Bio-Based and Vegan Materials</i>	66
2.9.3.3 <i>Design for Disassembly and Recycling</i>	66

2.10	CLIMATE CONTROL AND AIR QUALITY MANAGEMENT SYSTEMS	66
	2.10.1 Health Impacts of Indoor Pollution	67
	2.10.2 Introduction to Innovative Climate Control System	67
	<i>2.10.2.1 Integration of Arduino Microcontroller and Fuzzy Logic</i>	<i>67</i>
	<i>2.10.2.2 Sensors for Data Collection</i>	<i>67</i>
	2.10.3 System Performance and Comparison	68
	<i>2.10.3.1 Improved Air Quality, Temperature and Humidity Control</i>	<i>68</i>
	<i>2.10.3.2 Reduced Power Consumption and Comparison</i>	<i>68</i>
	<i>2.10.3.3 Conclusion and Future Implications</i>	<i>68</i>
2.11	EXPLORING RESEARCH GAP AND ITS PRACTICAL APPLICATION	68
CHAPTER 3	METHODOLOGY	70-88
3.1	PROCESS OF VEHICLE RIDE COMFORT	70
	3.1.1 Vehicle Modeling	70
	3.1.2 Simulation and Analysis	70
	3.1.3 Objective and Subjective Evaluation	70

3.1.4 Optimization and Refinement	71
3.1.5 Testing and Validation	71
3.2 OBJECTIVE OF VEHICLE RIDE COMFORT	71
3.2.1 Enhancing Passenger Experience	71
3.2.2 Minimizing Vibrations and Noise	72
3.2.3 Balancing Ride and Handling	72
3.2.4 Addressing Diverse Needs	72
3.2.5 Innovations in Ride Comfort	72
3.3 ASSUMPTIONS FOR VEHICLE RIDE COMFORT	73
3.3.1 Human Sensitivity to Vibrations	73
3.3.2 Vehicle Dynamics	73
3.3.3 Road Surface Conditions	73
3.3.4 Vehicle Speed and Driving Style	73
3.3.5 Passenger Positioning and Load Distribution	74

3.3.6 Acoustic Factors	74
3.3.7 Measurement and Evaluation Standards	74
3.3.8 Environmental Conditions	74
3.4 SYMBOLS SHAKTI SOFTWARE TOOL FOR MODELING AND SIMULATION	74
3.4.1 Modeling Capabilities	75
3.4.2 Symbolic Computation Engine	75
3.4.3 Code Generation and Integration	75
3.4.4 Simulation Features	75
3.4.5 Control Analysis Module	75
3.5 BOND GRAPH TOOL FOR DYNAMIC SYSTEM	76
3.6 CONCEPT OF BOND GRAPH ELEMENTS	77
3.6.1 Source of Effort (SE)	78
3.6.2 Source of Flow (SF)	78
3.6.3 The Inertia Element (I)	78
3.6.4 The Complaint Element (C)	79
3.6.5 The Resistive Element (R)	80
3.6.6 Transformer (TF)	80
3.7 DEVELOPMENT OF THE BOND GRAPH MODEL	80
3.8 CREATION OF SYSTEM EQUATION	82

	3.8.1 Method of System Equation Generation	83
	3.9 SYMBOLS BOND PAD	84
	3.10 SYMBOLS SIMULATOR MODULE	84
	3.11 SYMBOLS COMPILATION	85
	3.12 SYMBOLS SIMULATOR MODULE CIRCUIT	87
	3.13 SYMBOLS ONLINE PLOT	87
CHAPTER 4	MODELING AND ANALYSIS	89-110
-		
	4.1 DESIGN DEVELOPMENT AND ANALYSIS OF VEHICLE (FULL CAR) BY BOND GRAPH SIMULATION TECHNIQUES FOR COMFORT RIDE	90
	4.1.1 Full Car Models with a Fixed Suspension	90
	4.1.2 Road Excitation Model	92
	4.1.3 Vehicle Modeling	94
	4.1.4 Model Testing Using Bond Graph	95
	4.1.5 Modeling Road Profiles	97
	4.1.6 Comfort Measurement of a Full Car	99

	4.1.7 Road Excitation Modeling and Comfort Measurement	101
	4.1.8 Modeling Hinged Suspension through Bond Graph Based Full Car Model	106
	4.2 OUTCOME	109
CHAPTER 5	- RIDE COMFORT AND QUALITY ASSESMENT	111-147
	5.1 RIDE QUALITY: AN ESSENTIAL ASPECT OF TRANSPORTATION ENGINEERING	111
	5.1.1 Factors Influencing Ride Quality	111
	5.1.2 Measuring Ride Quality	111
	5.1.3 Enhancing Ride Quality	112
	5.1.4 Benefits of High Ride Quality	112
	5.2 RIDE COMFORT	113
	5.2.1 Factors Affecting Ride Comfort	113
	5.2.2 Measuring Ride Comfort	113
	5.2.3 Technological Advancements in Ride Comfort	114
	5.3 VEHICLE STABILITY	114
	5.3.1 Components of Vehicle Stability	114
	5.3.2 Types of Stability	115
	5.3.3 Enhancing Vehicle Stability	115
	5.3.4 Challenges in Vehicle Stability	115
	5.4 MEASURING AND IMPROVING ROAD VEHICLE COMFORT UNDER VARIOUS RUNNING CONDITIONS	116

5.4.1	Methods for Measuring Vehicle Comfort	116
5.4.2	Strategies to Improve Vehicle Comfort	116
5.4.3	Testing Under Various Running Conditions	117
5.4.4	Seat Comfort	117
5.4.5	Ride Quality	118
5.4.6	Climate Control	118
5.4.7	Technology and Features	118
5.4.8	Driving Experience	118
5.4.9	External Conditions	119
5.5	VEHICLE COMFORT PHENOMENA	119
5.5.1	Ride Quality and Suspension System	119
5.5.2	Noise, Vibration, and Harshness (NVH)	120
5.5.3	Climate Control and Air Quality	120
5.5.4	Ergonomics and Seating Comfort	120
5.5.5	Psychological Comfort	121
5.5.6	Technological Enhancements	121
5.6	VEHICLE COMFORT IS A CRUCIAL FACTOR IN AUTOMOTIVE DESIGN, ENSURING A PLEASANT EXPERIENCE FOR DRIVERS AND PASSENGERS	121
5.6.1	Ride Quality Assessment	121
5.6.2	Noise Measurement	122
5.6.3	Vibration Analysis	122

5.6.4	Seat Comfort Evaluation	122
5.6.5	Climate Control Assessment	122
5.6.6	Driver and Passenger Experience (Subjective Evaluation)	123
5.6.7	Long-Term Comfort Testing	123
5.7	VEHICLE INDICES USED TO EVALUATE COMFORT	123
5.7.1	Ride Quality Index (RQI)	124
5.7.2	Noise, Vibration, and Harshness (NVH) Index	124
5.7.3	Seat Comfort Index	124
5.7.4	Cabin Space and Layout Index	125
5.7.5	Climate Control Comfort Index	125
5.7.6	Vehicle Handling and Stability Index	126
5.8	VEHICLE DYNAMICS PERFORMANCE	126
5.8.1	Longitudinal Dynamics	126
5.8.2	Lateral Dynamics	127
5.8.3	Vertical Dynamics	127
5.8.4	Vehicle Stability and Handling	128
5.9	VEHICLE PERFORMANCE	128
5.9.1	Engine and Power Output	129
5.9.2	Acceleration and Top Speed	129
5.9.3	Handling and Suspension	129
5.9.4	Fuel Efficiency and Environmental Impact	130
5.9.5	Safety and Driver Assistance	130
5.9.6	Technology Integration and Performance Monitoring	131

5.10	EFFECT OF VERTICAL VIBRATION FREQUENCY IN VERTICAL DYNAMICS ANALYSIS	131
5.10.1	Vertical Vibration Frequency and System Behavior	131
5.10.2	Natural Frequency	131
5.10.3	Excitation Frequency	132
5.10.4	Resonance and Its Implications	132
5.10.5	Damping and Control of Vibrations	133
5.11	EFFECT OF VERTICAL VIBRATION FREQUENCY IN FULL CAR	133
5.11.1	Basic Concept of Vertical Vibration Frequency	133
5.11.2	Impact on Ride Comfort	134
5.11.3	Influence on Vehicle Handling and Stability	134
5.11.4	Resonance and Its Effects	135
5.11.5	Durability and Structural Integrity	135
5.12	SUSPENSION DEFLECTION IN A FULL CAR	135
5.12.1	Suspension System Basics	136
5.12.2	Factors Affecting Suspension Deflection	136
5.12.3	Mathematical Representation of Suspension Deflection	137
5.12.4	Impact of Suspension Deflection on Vehicle Performance	137
5.13	RMS VERTICAL BODY ACCELERATION	138
5.13.1	RMS Vertical Body Acceleration	138
5.13.2	The Concept of RMS in Vertical Body Acceleration	138
5.13.3	Significance of RMS Vertical Acceleration in Vehicle Dynamics	138
5.13.4	Human Comfort and Health Considerations	139

	5.13.5 Applications of RMS Vertical Acceleration	139
5.14	ROAD HOLDING TO ASSESS COMFORT IN A FULL CAR	140
	5.14.1 Tire Grip and Road Surface Interaction	140
	5.14.2 Suspension System and Comfort	141
	5.14.3 Vehicle Weight Distribution and Stability	141
	5.14.4 Aerodynamics and High-Speed Stability	142
	5.14.5 Braking Performance and Comfort	142
5.15	OVERALL VEHICLE PERFORMANCE	142
	5.15.1 Power train and Engine Performance	142
	5.15.2 Handling and Suspension	143
	5.15.3 Braking and Safety Performance	144
	5.15.4 Fuel Efficiency and Environmental Impact	144
	5.15.5 Technological Features and Comfort	144
5.16	COMMERCIAL MOTOR VEHICLES (CMV) ON INDIAN RURAL ROADS	145
	5.16.1 Role of Commercial Motor Vehicles in Rural Development	145
	5.16.2 Key Challenges Faced by CMVs on Rural Roads	145
	5.16.3 Government Regulations and Policies	146
	5.16.4 Community and Private Sector Involvement	147
	5.16.5 Future Outlook and Recommendations	147
CHAPTER 6	- PERFORMANCE ANALYSIS UNDER VARYING CONDITIONS	148-168
6.1	ANALYSIS AND DESIGN OF LIGHT	149

**VEHICLES FOR RURAL ROADS
CONSIDERING VIBRATION
GENERATED WITH BUMPS UP TO
150MM AND ITS PERFORMANCE**

6.2	ANALYSIS AND DESIGN FOR COMFORT RIDE OF 4-WHEELED VEHICLES VIBRATION ON RURAL ROAD SURFACE CONSIDERING TYRE COEFFICIENT AND TO REDUCE CLIMATE IMPACT	157
6.3	OUTCOME	168
CHAPTER 7	- RESULTS AND DISCUSSION	169-177
7.1	ANALYSIS AND DESIGN OF LIGHT VEHICLES FOR RURAL ROADS CONSIDERING VIBRATION WITH BUMPS UP TO 150 MM AND ITS PERFORMANCE	169
7.2	ANALYSIS AND DESIGN FOR COMFORT RIDE OF 4-WHEELED VEHICLES VIBRATION ON RURAL ROAD SURFACE CONSIDERING TYRE COEFFICIENT AND TO REDUCE CLIMATE IMPACT	173
CHAPTER 8	- CONCLUSION AND FUTURE SCOPE OF WORK	178-180
8.1	CONCLUSION	178
8.1.1	The Evaluation of a Vehicle's Response under the Conditions of Consistent Tyre Stiffness Coefficients, With Variations in both Speed and Road Bumps	178
8.1.2	The Evaluation of a Vehicle's Response to Transient Bumps and Damping Coefficients for both Rear	178

and Front Tyres

8.2 FUTURE SCOPE OF WORK	179
REFERENCES	181-187
APPENDICES	-
APPENDIX I C++ CODE TO A MACHINE LANGUAGE EXECUTABLE CODE	193
APPENDIX II LIST OF PUBLICATIONS OF RESEARCH SCHOLAR	194

LIST OF TABLES

TABLE NO.	CAPTIONS	PAGE NOS.
Table 3.1	Efforts and Flow Variables	76
Table 4.1	The Description Of The Elements Of The Bond Graph	91
Table 4.2	Parameters of a full car model with fixed and hinged suspension	91
Table 6.1	Parameter of full car model	154
Table 6.2	Parameters considered for 4-Wheeled vehicle representation	160
Table 7.1	Displacement vs. Time at 0.025m bump height at different Speeds of 25 km/hr, 50 km/hr, 75 km/hr100 km/hr and 125 km/hr	169
Table 7.2	Displacement vs. Time at 0.050 m bump height at different Speeds of 25 km/hr, 50 km/hr, 75 km/hr100 km/hr and 125 km/hr	170
Table 7.3	Displacement vs. Time at 0.075 m bump height at different Speeds of 25 km/hr, 50 km/hr, 75 km/hr100 km/hr and 125 km/hr	170
Table 7.4	Displacement vs. Time at 0.100 m bump height at different Speeds of 25 km/hr, 50 km/hr, 75 km/hr100 km/hr and 125 km/hr	171
Table 7.5	Displacement vs. Time at 0.125 m bump height at different Speeds of 25 km/hr, 50 km/hr, 75 km/hr100 km/hr and 125 km/hr	172
Table 7.6	Displacement vs. Time at 0.150 m bump height at different Speeds of 25 km/hr, 50 km/hr, 75 km/hr100 km/hr and 125 km/hr	173

LIST OF FIGURES

FIGURE NOS.	CAPTIONS	PAGE NOS.
Fig.1.1	Tyre Pressure Monitoring System (TPMS) using Android app	29
Fig.1.2	Vehicle Dynamics Control Unit. Stability control unit with pressure sensor less system and combination hydraulic circuit part and electronic control part (Mass: 1.96 kg)	31
Fig 2.1	Driver/system/vehicle interaction	44
Fig.2.2	Half-car model	45
Fig.2.3	Spring mass- damper model	46
Fig.2.4	VOAS-2 suspension on test vehicle	48
Fig.2.5	Vehicle systems models	49
Fig.2.6	Vehicle longitudinal forces	49
Fig.2.7	Full car suspension model	50
Fig.2.8	Full car model	53
Fig.2.9	Body-in-white with closures (courtesy: Arcelor Mittal Tailored Blanks)	64
Fig.2.10	Trans boundary movement of mineral dust over South Asia <i>Note:</i> Both true color and AOD images are courtesy of Terra MODIS	67
Fig.3.1	1 Junction element models	81
Fig.3.2	0 Junction element models	82
Fig.3.3	Symbols bond pad	84
Fig.3.4	Symbols simulator module	85
Fig.3.5	Symbols compilation window	86
Fig.3.6	Symbols compilation window .	86
Fig.3.7	Symbols simulator module- Circuit.ext	87
Fig.3.8	Online Plot	88
Fig.4.1	Full car model with a fixed Suspension	90
Fig.4.2	Bond graph model of full car model with a fixed Suspension	103
Fig.4.3	Rocking motion of the full car model at front suspension with vertical angular displacement C.G	104
Fig.4.4	Heaving motion of the full car model at rear suspension with vertical displacement C.G.	105
Fig.4.5	Rocking motion of the full car model at front suspension with vertical angular displacement C.G	105
Fig.4.6	Heaving motion of the full car model at rear suspension with vertical displacement C.G.,	105
Fig.4.7	Full car model with hinged suspension	106

Fig.4.8	Bondgraph model of full car model with a hinged suspension	108
Fig.4.9	Heaving motion of the full car model at rear suspension	109
Fig.6.1	Dynamic model	150
Fig.6.2	Dynamic model with pitching	153
Fig.6.3	Sprung-Mass Displacement vs. Time at Bump height 0.025 m and a speed of (a) 25 km/h, (b) 50 km/h, (c) 75 km/h, (d) 100 km/h, and (e) 125 km/h.	155
Fig.6.4	Sprung-Mass Displacement vs. Time at Bump height 0.050 m and a speed of (a) 25 km/h, (b) 50 km/h, (c) 75 km/h, (d) 100 km/h, and (e) 125 km/h.	155
Fig.6.5	Sprung-Mass Displacement vs. Time at Bump height 0.075m and a speed of (a) 25 km/h, (b) 50 km/h, (c) 75 km/h, (d) 100 km/h, and (e) 125 km/h.	156
Fig.6.6	Sprung-Mass Displacement vs. Time at Bump height 0.100m and a speed of (a) 25 km/h, (b) 50 km/h, (c) 75 km/h, (d) 100 km/h, and (e) 125 km/h.	156
Fig.6.7	Sprung-Mass Displacement vs. Time at Bump height 0.125m and a speed of (a) 25 km/h, (b) 50 km/h, (c) 75 km/h, (d) 100 km/h, and (e) 125 km/h.	157
Fig.6.8	Sprung-Mass Displacement vs. Time at Bump height 0.150 m and a speed of (a) 25 km/h, (b) 50 km/h, (c) 75 km/h, (d) 100 km/h, and (e) 125 km/h.	157
Fig.6.9	Four wheeled car model when front and rear load are equal	158
Fig.6.10	Four wheeled car model having different load	158
Fig.6.11	Vehicle Representation	159
Fig.6.12	Sprung-mass displacement vs. Time lag for comfortzone, when rear <i>tyre damping coefficient</i> (br) = 4 kNs/m and speed = 25 km/h.	161
Fig.6.13	Sprung-mass displacement vs. Time lag for comfort zone, when rear <i>tyre damping coefficient</i> (br) = 4 kNs/m and speed = 50 km/h	161
Fig.6.14	Sprung-mass displacement vs. Time lag for comfortzone, when rear <i>tyre damping coefficient</i> (br) = 4 kNs/m and speed = 75 km/h.	162
Fig.6.15	Sprung-mass displacement vs. Time lag for comfortzone, when rear <i>tyre damping coefficient</i> (br) = 4 kNs/m and speed = 100 km/h.	162
Fig.6.16	Sprung-mass displacement vs. Time lag for comfortzone, when rear <i>tyre damping coefficient</i> (br) = 4 kNs/m and speed = 125 km/h.	162

Fig.6.17	Sprung-mass displacement vs. Time lag for comfortzone, when front tyre damping coefficient (bf) = 8 kNs/m and Speed = 25 km/h	163
Fig.6.18	Sprung-mass displacement vs. Time lag for comfortzone, when front tyre damping coefficient (bf) = 8 kNs/m and speed = 50 km/h.	163
Fig.6.19	Sprung-mass displacement vs. Time lag for comfortzone, when front tyre damping coefficient (bf) = 8 kNs/m and speed = 75 km/h	163
Fig.6.20	Sprung-mass displacement vs. Time lag for comfortzone, when front tyre damping coefficient (bf) = 8 kNs/m and speed = 100 km/h.	164
Fig.6.21	Sprung-mass displacement vs. Time lag for comfortzone, when front tyre damping coefficient (bf) = 8 kNs/m and speed = 125 km/h.	164
Fig.6.22	Sprung-mass displacement vs. Time lag for comfort zone, when rear tyre damping coefficient (br) = 12 kNs/m and speed = 25 km/h.	164
Fig.6.23	Sprung-mass displacement vs. Time lag for comfortzone, when rear tyre damping coefficient (br) = 12 kNs/m and speed = 50 km/h.	165
Fig.6.24	Sprung-mass displacement vs. Time lag for comfortzone, when rear tyre damping coefficient (br) = 12 kNs/m and speed = 75 km/h	165
Fig.6.25	Sprung-mass displacement vs. Time lag for comfortzone, when rear tyre damping coefficient (br) = 12 kNs/m and speed = 100 km/h.	165
Fig.6.26	Sprung-mass displacement vs. Time lag for comfortzone, when rear tyre damping coefficient (br) = 12 kNs/m and speed = 125 km/h.	166
Fig.6.27	Sprung-mass displacement vs. Time lag for comfortzone, when front tyre damping coefficient (bf) = 16 kNs/m and speed = 25 km/h.	166
Fig.6.28	Sprung-mass displacement vs. Time lag for comfortzone, when front tyre damping coefficient (bf) = 16 kNs/m and speed = 50 km/h.	166
Fig.6.29	Sprung-mass displacement vs. Time lag for comfort zone, when front tyre damping coefficient, bf = 16 kNs/m and speed = 75 km/h.	167
Fig.6.30	Sprung-mass displacement vs. Time lag for comfort zone, when front tyre damping coefficient, bf = 16 kNs/m and speed = 100 km/h.	167

Fig.6.31 Sprung-mass displacement vs. Time lag for comfort zone, when *front tyre damping coefficient*, $b_f = 16$ kNs/m and speed = 125 km/h 167

NOMENCLATURE

e_m	Magneto-motive force
F	Force
f	Flow
h	Enthalpy
i	Current
P	Pressure
v	Velocity
V	Voltage
μ	Chemical potential
τ	Torque
ω	Angular velocity
dm/dt	Mass flow rate
dN/dt	Mole flow rate
dQ/dt	Volume flow rate
ds/dt	Entropy change rate
dV/d	Volume change rate
0	Effort equation junction
1	Flow equation junction
C	Complement element
I	Inertial element
R	Resistive element
ϕ	Magnetic flux
SE	Source of effort
SF	Source of flow
TF	Transformer
[A]	System matrix
[B]	Input matrix
[U]	Input vector
[X]	State vector
a	Distance of rear wheel from C.G
b	Distance of front wheel from C.G
h	Height of ground excitation
J _{bf}	Moment of inertia of the hinged suspension arm of the full car
J _{br}	Moment of inertia of the rear suspension arm of the full car
J _c	Moment of inertia of the full car
K _{1f}	Front stiffness
K _{1r}	Rear stiffness
K _{2f}	Front stiffness
K _{2r}	Rear stiffness
K _{3f}	Front stiffness

K_{3r}	Rear stiffness
l	Length of ground excitation
M_{bf}	Mass of the hinged suspension arm of the full car
M_{bfg}	Weight of the hinged suspension arm of the full car
M_{br}	Mass of the rear suspension arm of the full car
M_{brg}	Weight of the rear suspension arm of the full car
M_c	Mass of the full car
M_{cg}	Weight of the full car
R_{1f}	Front damper
R_{1r}	Rear damper
R_{2f}	Front damper
R_{2r}	Rear damper
R_{3f}	Front damper
R_{3r}	Rear damper
v	Velocity of the full car

ABBREVIATIONS

ARR	Analytical Reduction Relationships
BG	Bond Graph
CSS	Complex System Simulator
DDL	Dynamic Link Library
DOF	Degree Of Freedom
ESL	Engineering System Laboratory
FDI	Falt Detection and Isolation
GUI	Graphical User Interface
ICE	Internal Combustion Engine
LQR	Linear Quadratic Regulator
MB	Model Builder
MDI	Multiple Doucument Interfaces
NVH	Noise Vibration Harshness
ODE	Ordinary Differantial Equation
UDMT	User Define Model Type
VOAS-2	Volvo Optimized Air Suspension-2

(Signature of Research Scholar)

Name: Manoj Kumar Singh

Enroll. No. :13ME1715

CHAPTER 1

INTRODUCTION

In the ever-evolving landscape of transportation, ensuring the comfort of passengers has emerged as a pivotal concern for designers, engineers, and manufacturers. Ride comfort, a multifaceted attribute encompassing factors such as vibration dampening, noise reduction, and ergonomic design, holds profound significance in the modern era of transportation. This emphasis on comfort is not merely a matter of luxury or convenience, but a fundamental component of safety, well-being, and overall user satisfaction.

As the demands on transport vehicles continue to expand, encompassing a diverse range of environments and operational conditions, the need for optimal ride comfort has become increasingly acute. Whether navigating urban thoroughfares, traversing intercity distances, or negotiating rough terrains, passengers' experience of the journey profoundly impacts their physical and mental well-being. It influences not only their immediate comfort but also their perception of the vehicle's quality, trustworthiness, and suitability for future travel.

Moreover, in a global context where sustainability and environmental consciousness are paramount, ride comfort has gained prominence as a critical factor in the adoption of public transit and shared mobility solutions. A comfortable ride can sway individuals towards choosing collective modes of transport over private vehicles, contributing to reduced congestion, lower emissions, and improved overall urban livability.

Beyond its immediate implications for passengers, ride comfort reverberates through various sectors and industries. For instance, in the healthcare domain, especially in the case of ambulances and medical transport, ensuring a smooth and comfortable ride can significantly impact patient outcomes. In commercial applications, such as long-haul trucking, the well-being and alertness of drivers hinge on the quality of the vehicle's ride.

India possesses the world's second-largest road network, spanning 62,15,797 km, trailing only the United States with 68,53,024 km as on March 2020. The country has hardly constructed national highways, expressways, state highways, contributing to a total length of 3,15,349 km. remarkably; more than 50% of this extensive road network

is situated in rural areas, consisting of surfaces not fortified with cement pavement or bituminous materials of requisite strength. Despite lacking these enhancements, these rural roads play a pivotal role in the transportation of the rural population. The prevalence of uneven surfaces, potholes, and damaged road sections leads to significant discomfort, stress, and fatigue for both passengers and drivers of light vehicles, such as transport carriers, passenger cars, or jeeps.

In light of these considerations, this research work delves into the essential elements that underpin ride comfort in transport vehicles. By exploring the intricate interplay of factors such as suspension design, damping characteristics, tyre properties, and passenger compartment ergonomics, we aim to shed light on the holistic approach required to optimize comfort. Furthermore, this research endeavors to evaluate various modeling techniques, with a particular focus on the Bond Graph method, in the pursuit of achieving superior ride comfort standards.

In essence, the significance of ride comfort transcends the boundaries of mere convenience; it is a cornerstone of safe, sustainable, and inclusive transportation systems that cater to the diverse needs and preferences of passengers in an ever-evolving world.

1.1 BRIEF OVERVIEW OF THE MAIN SALIENT FEATURES INFLUENCING RIDE COMFORT

1.1.1 Suspension System Design

The suspension system of a vehicle is a critical component that directly impacts the overall performance, safety, and comfort of the vehicle. Its primary function is to manage the interaction between the tyres and the road surface, providing stability, control, and a comfortable ride for the occupants. Suspension systems come in various designs, ranging from simple systems in basic vehicles to sophisticated setups in high-performance and luxury cars. One of the fundamental purposes of the suspension system is to absorb shocks and vibrations from the road, preventing them from directly transmitting to the vehicle's occupants. Without a properly designed suspension system, the ride quality would be compromised, leading to discomfort for passengers and potential damage to the vehicle's structure [1].

An optimally designed suspension system takes into consideration various factors such as the vehicle's weight, load distribution, intended use (off-road, performance driving, daily commuting), and desired ride comfort. It involves a careful balance between stiffness and compliance to ensure the tyres maintain optimal contact with the road surface while minimizing the impact of irregularities.

1.1.1.1 Challenges and Advances in Suspension System Design

While the fundamental principles of suspension system design remain consistent, advancements in technology have led to innovative solutions that address specific challenges and push the boundaries of performance and comfort. One notable challenge is achieving a balance between ride comfort and dynamic handling, as these goals often require compromises in design.

Recent advances include the development of adaptive suspension systems, where electronic sensors continuously monitor various parameters such as vehicle speed, steering input, and road conditions. Based on this real-time data, the system adjusts the damping characteristics to optimize both comfort and handling. This technology offers the flexibility to switch between a softer setting for cruising and a firmer setting for more spirited driving.

Another area of innovation is the use of air suspension systems, which replace traditional coil springs with airbags. Air suspension allows for variable ride height, providing the flexibility to adjust ground clearance for different driving conditions. This not only enhances off-road capability but also improves aerodynamics and fuel efficiency at higher speeds by lowering the vehicle.

As the design of a vehicle's suspension system is a complex and crucial aspect of automotive engineering, it involves a delicate balance between comfort, stability, and performance. Therefore suspension system is pivotal in absorbing shocks and vibrations from the road surface, ensuring that they do not directly reach the vehicle's occupants. An optimally designed suspension system minimizes jolts and oscillations, contributing significantly to ride comfort.

1.1.2 Damping Characteristics and Importance

One crucial aspect of suspension system design is the incorporation of damping characteristics, mainly achieved through shock absorbers or dampers. Dampers control the rate at which the suspension system compresses and rebounds, effectively managing the oscillations induced by bumps, potholes, and other disturbances on the road.

Properly tuned dampers play a pivotal role in enhancing ride comfort and vehicle stability. They reduce the tendency of the suspension system to bounce excessively, ensuring that the tyres stay in contact with the road for improved traction and control. The damping characteristics are finely tuned based on the specific requirements of the vehicle, taking into account factors such as weight distribution, spring rates, and intended use.

In addition to enhancing ride comfort, effective damping also contributes to vehicle safety. It prevents uncontrolled oscillations that could lead to loss of control, especially during rapid maneuvers or emergency situations. Without proper damping, a vehicle may exhibit excessive body roll, nose-diving during braking, and unpredictable behavior when encountering uneven road surfaces.

Furthermore, damping characteristics are crucial for maintaining consistent tyre contact with the road, ensuring optimal grip and handling. In high-performance vehicles, where precise control is paramount, the damping system is often adjustable, allowing drivers to fine-tune the suspension settings according to their preferences or specific driving conditions.

As damping characteristics, controlled by shock absorbers, play a central role in achieving these objectives. Advancements in suspension technology continue to push the boundaries of what is possible, offering drivers a harmonious blend of comfort and performance in various driving conditions. Thus, dampers, or shock absorbers, play a crucial role in controlling the rate at which the suspension system oscillates. Properly tuned dampers reduce bounce and sway, resulting in a smoother and more controlled ride.

1.1.3 Tyre Characteristics, Ride Quality and Technology

Tyres are one of the most critical components of a vehicle, serving as the sole point of contact between the vehicle and the road. The characteristics of tyres, including size, tread pattern, and material composition, play a pivotal role in determining various aspects of a vehicle's performance, safety, and ride quality.

Tyre Size: The size of a tyre is a fundamental consideration in tyre selection. It encompasses dimensions such as tyre width, aspect ratio, and diameter. Each of these factors influences the tyre's contact patch with the road, which directly affects grip, handling, and ride comfort. Wider tyres generally offer more grip, especially in cornering, while narrower tyres may provide better fuel efficiency. The aspect ratio, representing the sidewall height as a percentage of the tyre's width, contributes to the tyre's ability to absorb impacts and impacts the overall ride comfort.

Tread Pattern: The tread pattern on a tyre surface is another critical aspect influencing its performance. Tread patterns vary widely, ranging from directional, asymmetrical, to symmetrical designs. The choice of tread pattern is often dictated by the intended use of the vehicle. For instance, off-road tyres may have aggressive, deep treads for better traction on uneven terrain, while high-performance tyres may feature a more streamlined, less aggressive pattern to maximize contact with the road. Additionally, siping (small grooves) on the tread helps with water dispersion, improving wet traction and reducing the risk of hydroplaning.

Material Composition: The materials used in tyre construction significantly impact their performance characteristics. The most common tyre type is the pneumatic tyre, typically composed of layers of fabric and steel cords encased in rubber. The composition of the rubber compound can vary, with some tyres using softer compounds for enhanced grip (common in performance tyres) and others opting for harder compounds to improve durability and tread life (common in all-season or touring tyres). Run-flat tyres, reinforced with additional support structures, allow a vehicle to continue driving even after a loss of air pressure.

1.1.3.1 Impact of Tyre Characteristics on Ride Quality

- **Tyre Grip and Handling:** One of the primary roles of a tyre is to provide adequate grip on the road surface. The choice of tyre size and tread pattern significantly influences a vehicle's handling characteristics. High-performance tyres with a wide contact patch and a more aggressive tread pattern enhance cornering ability, responsiveness, and overall handling. On the other hand, touring or all-season tyres may prioritize a balance between grip and a smoother, quieter ride.
- **Ride Comfort:** The material composition of the tyre, particularly the flexibility of the sidewalls and the cushioning effect of the tread, has a direct impact on ride comfort. Softer sidewalls can absorb more road irregularities, resulting in a smoother ride. However, there is a trade-off, as excessively soft sidewalls can compromise handling and responsiveness. Luxury vehicles often come equipped with tyres designed to prioritize comfort, utilizing advanced technologies and materials to minimize road noise and vibrations.
- **Noise Levels:** Tyre noise, often referred to as road noise, is another crucial factor in ride quality. Tread pattern, tyre construction, and the type of rubber compound can affect the level of noise generated while driving. Tyres with a more aggressive tread pattern may produce more noise, especially at higher speeds. Manufacturers employ various techniques, such as noise-canceling technologies and optimized tread designs, to mitigate road noise and enhance the overall driving experience.

1.1.3.2 Advances in Tyre Technology

- **Run-Flat Tyres:** Run-flat tyres are a notable advancement in tyre technology. These tyres are designed to allow a vehicle to continue driving safely for a limited distance, even after a loss of air pressure. This eliminates the need for a spare tyre and provides added convenience and safety. Run-flat technology often involves reinforced sidewalls that

can support the vehicle's weight, allowing the driver to reach a repair facility.

- **Low Rolling Resistance Tyres:** With a growing emphasis on fuel efficiency and environmental sustainability, low rolling resistance tyres have gained popularity. These tyres are designed to reduce the energy required to keep the tyre rolling. By minimizing internal friction, low rolling resistance tyres contribute to improved fuel efficiency, making them an attractive option for eco-conscious drivers. However, there can be trade-offs in terms of grip and performance, and manufacturers aim to strike a balance between efficiency and safety.
- **Smart Tyres and Tyre Pressure Monitoring Systems (TPMS):** Recent advancements include the integration of smart technologies into tyres. Some tyres are equipped with sensors that provide real-time data on tyre pressure, temperature, and tread wear. This information can be transmitted to the vehicle's onboard computer or directly to the driver through a connected system. Tyre Pressure Monitoring Systems (TPMS) have become standard in many vehicles, enhancing safety by alerting drivers to significant changes in tyre pressure, reducing the risk of blowouts and improving overall tyre longevity.

As tyre characteristics are integral to the overall performance and ride quality of a vehicle. The careful consideration of factors such as tyre size, tread pattern, and material composition allows manufacturers and consumers to tailor a vehicle's tyres to specific needs, whether it be high-performance handling, enhanced comfort, or improved fuel efficiency. Advances in tyre technology continue to drive improvements in safety, efficiency, and overall driving experience. Thus, tyre selection, including factors like tyre size, tread pattern, and material composition, directly impacts ride quality. Well-chosen tyres can enhance grip, reduce road noise, and absorb road irregularities.

1.1.4 Vehicle Mass and Inertia: Understanding, Trade off and Balancing

Vehicle mass, also known as weight, is a fundamental factor that influences a vehicle's behavior on the road. Mass is the amount of matter in an object, and in the context of vehicles, it refers to the total weight of the vehicle, including its chassis, body, engine, fluids, passengers, and cargo. Inertia, closely related to mass, is the resistance of an object to changes in its state of motion. The greater the mass, the greater the inertia, and this has significant implications for a vehicle's ride, handling, and overall performance.

1.1.4.1 Stability and Inertia: Heavier vehicles generally exhibit greater stability on the road due to their higher inertia. Inertia helps resist changes in motion, making it more challenging for external forces to alter the vehicle's trajectory.

This quality is particularly beneficial for maintaining stability during straight-line driving, as well as when encountering crosswinds or other external disturbances. The increased inertia contributes to a smoother and more controlled ride, especially at higher speeds, as the vehicle is less susceptible to being easily swayed or pushed around.

1.1.4.2 Trade-offs Between Mass, Inertia, and Fuel Efficiency

- ***Fuel Efficiency and Excessive Weight:*** While greater mass and inertia contribute to stability, there is a trade-off with fuel efficiency. Excessive vehicle weight requires more energy to move, resulting in higher fuel consumption. The power needed to accelerate, brake, and overcome aerodynamic resistance is directly influenced by the vehicle's mass. Therefore, manufacturers face the challenge of finding a balance between designing vehicles with sufficient mass for stability and safety while avoiding unnecessary weight that would compromise fuel efficiency.
- ***Impact on Acceleration and Braking:*** The relationship between mass, inertia, and fuel efficiency is evident in a vehicle's acceleration and braking performance. Heavier vehicles take longer to accelerate due to the increased inertia, requiring more energy to overcome the resistance to motion. Similarly, braking distances are longer for heavier vehicles, as the brakes must dissipate more kinetic energy. This trade-off becomes particularly important in urban driving conditions, where frequent acceleration and deceleration occur.
- ***Handling and Maneuverability:*** While increased mass contributes to stability, it can also affect a vehicle's handling and maneuverability. Heavier vehicles may feel less responsive in terms of steering and cornering compared to lighter counterparts. This is because higher mass increases the force required to change the vehicle's direction, leading to a perceived reduction in agility. Manufacturers address this challenge through various design elements, such as suspension tuning, tyre selection, and advanced chassis technologies, to strike a balance between stability and maneuverability.

1.1.4.3 Balancing Mass and Inertia for Optimal Ride Comfort

- ***Chassis Design and Materials:*** Manufacturers employ advanced materials and chassis design techniques to optimize the balance between mass and inertia. The use of lightweight yet durable materials, such as high-strength alloys and composites, allows for the construction of vehicles with lower overall mass without compromising structural integrity. This approach enhances fuel efficiency while maintaining adequate stability and safety.
- ***Suspension Tuning:*** The design and tuning of a vehicle's suspension system play a crucial role in managing the impact of mass and inertia on ride comfort. A well-tuned suspension system can mitigate the negative

effects of weight, providing a smoother ride by effectively absorbing and dampening road irregularities. Balancing stiffness and compliance in the suspension components is essential to optimize handling without sacrificing comfort.

- **Advanced Technologies:** Advancements in automotive technologies, including electronic stability control (ESC), traction control systems, and adaptive suspension systems, contribute to achieving an optimal balance between mass, inertia, and ride comfort. ESC, for instance, helps prevent skidding and loss of control by selectively applying brakes to individual wheels. Adaptive suspension systems can adjust damping rates in real-time, enhancing ride comfort and handling based on driving conditions.

As the interplay between vehicle mass, inertia, and fuel efficiency is a complex balancing act for automotive engineers, heavier vehicles with greater inertia tend to provide a more stable ride, especially at higher speeds, but this comes at the cost of reduced fuel efficiency. Striking the right balance involves leveraging advanced materials, optimizing chassis design, and employing sophisticated technologies to ensure that the vehicle's mass contributes positively to ride comfort and safety without compromising overall efficiency. The pursuit of this equilibrium reflects the ongoing evolution of automotive engineering to meet the diverse needs of drivers and address the challenges of performance, safety, and environmental sustainability. Thus, heavier vehicles tend to have more stable rides due to their greater inertia. However, excessive weight can lead to a compromise in fuel efficiency. Balancing mass and inertia is essential for optimal ride comfort.

1.1.5 Road Surface Interaction

The interaction between a vehicle's tyres and the road surface is a critical factor that directly influences ride quality, handling, and overall driving experience. The condition of the road surface plays a pivotal role in determining how well a vehicle can maintain traction, absorb shocks, and deliver a comfortable ride to its occupants.

1.1.5.1 Smooth vs. Rough Surfaces: Smooth, well-maintained roads contribute to a more comfortable and enjoyable driving experience. A smooth road surface allows for consistent tyre contact, reducing vibrations and minimizing the impact of irregularities on the vehicle's suspension system. On the other hand, rough or deteriorated surfaces can result in a jarring and less pleasant ride, as the tyres encounter bumps, potholes, and other imperfections that transfer forces and vibrations to the vehicle's chassis.

1.1.5.2 Impact on Ride Quality and Vehicle Dynamics

- **Ride Comfort:** The quality of the road surface directly affects ride comfort. A smooth road provides a more cushioned and stable ride, as

the suspension system can better absorb minor imperfections. In contrast, a bumpy or uneven road surface can lead to a harsh and less comfortable experience, causing discomfort for the occupants and potentially leading to fatigue during extended periods of driving. For this reason, urban planners, engineers, and policymakers emphasize the importance of well-maintained road infrastructure to enhance overall road safety and user satisfaction.

- ***Traction and Handling:*** Road surface conditions also play a crucial role in determining the level of traction and handling a vehicle can achieve. A well-maintained road with good traction allows the tyres to grip the surface consistently, enhancing the vehicle's stability and maneuverability. In adverse weather conditions, such as rain or snow, the condition of the road surface becomes even more critical. Wet or icy roads reduce traction, impacting both acceleration and braking performance. Tyres may struggle to maintain grip, leading to skidding or loss of control. Proper road maintenance and the use of materials designed for different climates can mitigate these challenges and contribute to safer driving conditions.

1.1.5.3 Considerations for Road Surface Improvement

- ***Infrastructure Maintenance:*** To enhance road surface interaction and improve overall ride quality, ongoing infrastructure maintenance is essential. This includes regular inspection and repair of roads, addressing issues such as potholes, cracks, and uneven surfaces. Properly maintained roads not only contribute to a smoother ride but also extend the lifespan of vehicles by reducing the wear and tear on suspension components and tyres.
- ***Innovations in Road Construction:*** Advancements in road construction materials and techniques also contribute to improved road surface interaction. Innovations such as the use of high-quality asphalt mixes, innovative road surface textures, and the incorporation of materials designed to enhance traction and durability all play a role in creating road surfaces that are more conducive to a comfortable and safe driving experience.
- ***Smart Infrastructure Solutions:*** The future of road surface interaction involves the integration of smart infrastructure solutions. Intelligent transportation systems can utilize sensors embedded in the road surface to monitor conditions in real-time. This information can be used to alert drivers to potential hazards, optimize traffic flow, and enhance overall road safety. Additionally, the development of smart road materials that can adapt to changing conditions, such as temperature or precipitation, holds promise for further improving the interaction between vehicles and the road surface.

As the relationship between a vehicle and the road surface is a dynamic and multifaceted one, a well-maintained, smooth road surface contributes to enhanced ride quality, improved handling, and increased overall safety. As technology and materials continue to advance, the future of road surface interaction holds the potential for even more sophisticated solutions that prioritize comfort, safety, and efficiency for drivers and passengers alike. Therefore, the condition of the road surface significantly affects ride quality. Smooth, well-maintained roads provide a more comfortable ride compared to rough or deteriorated surfaces.

1.1.6 Passenger Compartment Ergonomics

Passenger compartment ergonomics is a crucial aspect of automotive design that focuses on creating a comfortable and user-friendly interior space for vehicle occupants. The design of the passenger compartment directly impacts the overall driving experience, as well as the well-being and satisfaction of passengers. Key elements of passenger compartment ergonomics include seat design, cushioning, layout, and the positioning of controls and interfaces within reach of the driver and passengers.

1.1.6.1 Seat Design and Ergonomics

The design of the seats is paramount in ensuring passenger comfort during short drives and long journeys alike. Ergonomically designed seats take into account the natural curves of the human body, providing optimal support to the spine, buttocks, and thighs. Elements such as seat shape, contouring, and materials contribute to proper posture and reduce the risk of fatigue and discomfort. Additionally, the adjustment features of seats, including height, tilt, and lumbar support, allow passengers to personalize their seating position for maximum comfort.

1.1.6.2 Considerations for Seat Cushioning and Layout

- **Seat Cushioning:** The cushioning of seats is a critical factor in passenger comfort. It affects how well the seats absorb vibrations from the road and impacts overall support. High-quality cushioning materials that strike a balance between softness and firmness can enhance comfort and reduce fatigue during extended periods of driving. Seat cushioning is especially important for long journeys, where inadequate support can lead to discomfort and contribute to health issues.
- **Legroom and Seating Layout:** Adequate legroom is essential for passenger comfort, especially in the rear seats. The layout of the passenger compartment, including the positioning of seats, influences the available legroom for each occupant. The design of the front and rear seats must consider the average height of passengers and provide enough space to prevent feelings of claustrophobia or discomfort. The layout

also impacts the ease of entry and exit, ensuring that passengers can comfortably get in and out of the vehicle.

- **Headrest Positioning:** Proper headrest positioning is crucial for both comfort and safety. Headrests are designed to support the head and neck, reducing the risk of whiplash injuries during rear-ends collisions. Adjustable headrests allow occupants to customize the position according to their height and preferences, enhancing comfort and safety simultaneously. A well-positioned headrest contributes to maintaining proper spinal alignment and preventing fatigue during extended drives.

1.1.6.3 Advances in Passenger Compartment Ergonomics

- **Technology Integration:** Advancements in automotive technology have expanded the scope of passenger compartment ergonomics. Integrated infotainment systems, climate control interfaces, and connectivity features are now seamlessly incorporated into the interior design. Touch screens, voice recognition, and intuitive controls contribute to a more user-friendly experience, allowing passengers to access entertainment, navigation, and other functions with ease.
- **Adjustable Features:** Modern vehicles often come equipped with a variety of adjustable features to cater to individual preferences. Power-adjustable seats, steering wheel tilt and telescopic adjustments, and customizable driver profiles contribute to a personalized and comfortable driving experience. These features accommodate the diverse needs of drivers and passengers, ensuring that individuals of varying sizes and body types can find an optimal seating position.
- **Materials and Aesthetics:** The choice of materials for the interior surfaces plays a role in both comfort and aesthetics. High-quality, durable materials not only enhance the overall feel of the passenger compartment but also contribute to long-term durability. Additionally, attention to detail in terms of color schemes, ambient lighting, and interior finishes can create a visually appealing and inviting environment, contributing to the overall satisfaction of passengers.

It is noticed that passenger compartment ergonomics is a multifaceted discipline that combines the principles of human-centered design with technological innovations. The goal is to create an interior space that not only prioritizes comfort and safety but also integrates seamlessly with modern lifestyles. As automotive design continues to evolve, passenger compartment ergonomics may likely see further advancements, with an increased emphasis on individual customization and the integration of cutting-edge technologies to enhance the overall driving experience. Thus, interior design considerations, including seat design, cushioning, and layout, play a critical role in passenger comfort. Adequate legroom, lumbar support, and headrest positioning are crucial factors.

1.1.7 Environmental Factors impacting Ride Comfort

1.1.7.1 Ride comfort in vehicles: It is influenced by various environmental factors that encompass both natural and man-made elements. The interaction between a vehicle and its environment significantly impacts the overall comfort experienced by passengers. Addressing these environmental factors is crucial for automotive engineers and designers aiming to create vehicles that provide a smooth and enjoyable ride while minimizing the impact on the environment. Key environmental factors influencing ride comfort include road conditions, weather, and noise pollution.

1.1.7.2 Road Conditions: Road conditions are a primary environmental factor affecting ride comfort. The quality of the road surface, including smoothness, potholes, and irregularities, directly influences the vibrations transmitted to the vehicle. Well-maintained roads with even surfaces contribute to a smoother ride, while deteriorated or uneven roads can result in a bumpier experience. Engineers address these challenges through advanced suspension systems, shock absorbers, and tyre technologies designed to absorb and dampen road-induced vibrations.

1.1.7.3 Weather Conditions and their Impact on Ride Comfort

- ***Weather Conditions:*** Weather conditions play a significant role in determining ride comfort, especially in open-air or convertible vehicles. Rain, snow, and extreme temperatures can affect visibility, traction, and overall driving dynamics. The design of convertible vehicles, for instance, must consider factors such as water ingress and wind noise. Additionally, adverse weather conditions can impact road surfaces, leading to reduced grip and potentially affecting ride quality. Advanced climate control systems and weather-resistant materials are employed to mitigate these effects, ensuring a comfortable environment for passengers in various weather conditions.
- ***Temperature and Climate:*** Extreme temperatures, whether hot or cold, can influence the comfort inside a vehicle. In hot climates, efficient air conditioning systems and sun-reflective materials help maintain a comfortable interior temperature. In cold climates, effective heating systems and insulated materials contribute to passenger well-being. The integration of advanced climate control technologies, including seat heating and ventilation, further enhances the ability to create a comfortable interior environment regardless of external temperature extremes.

1.1.7.4 Noise Pollution and the Role of Environmental Factors in Ride Comfort

- ***Noise Pollution:*** Noise pollution, originating from both external and internal sources, significantly impacts ride comfort. External sources include road noise, wind noise, and traffic sounds, while internal sources

may involve engine noise, tyre noise, and mechanical vibrations. Engineers employ various strategies to minimize noise pollution, including the use of soundproofing materials, aerodynamic design improvements, and advanced insulation techniques. Additionally, advancements in electric and hybrid vehicles contribute to reducing overall noise levels, enhancing the acoustic environment inside the cabin.

- **Urban Environments:** The nature of the driving environment, whether urban or rural, influences ride comfort. Urban environments are often characterized by traffic congestion, stop-and-go driving, and frequent changes in speed. These conditions can lead to increased stress for drivers and passengers, affecting the overall comfort of the ride. Automotive technologies such as adaptive cruise control, automatic emergency braking, and traffic-aware navigation systems aim to mitigate these challenges, providing a smoother and less stressful driving experience in urban settings.
- **Environmental Sustainability:** Considering the broader context of environmental sustainability, manufacturers are increasingly incorporating eco-friendly materials and technologies in vehicle design. This includes the use of recycled materials, energy-efficient manufacturing processes, and the development of electric and hybrid vehicles with lower emissions. These initiatives not only contribute to environmental conservation but also align with the growing consumer demand for eco-conscious and socially responsible transportation options.

Since ride comfort in vehicles is intricately linked to various environmental factors, ranging from road conditions and weather to noise pollution and the overall driving environment, these factors requires addressing a combination of advanced engineering solutions, innovative technologies, and a commitment to environmental sustainability. As the automotive industry continues to evolve, the integration of eco-friendly practices and cutting-edge technologies will play a vital role in enhancing ride comfort while minimizing the environmental impact of vehicular transportation. Therefore, environmental conditions, such as temperature and humidity, noise pollution, can impact ride comfort vehicle. Effective climate control systems, ventilation, and insulation contribute to a pleasant interior environment.

Understanding and optimizing these salient features is essential for creating vehicles that provide a comfortable, enjoyable, and safe experience for passengers. By meticulously considering these factors, manufacturers can design vehicles that cater to a wide range of preferences and requirements, ultimately enhancing the overall quality of transportation experiences.

1.2 THE PURPOSE AND STRUCTURE OF THE "COMFORTABLE RIDE OF TRANSPORT VEHICLES" STUDY

The main purpose of study is to investigate and analyze the factors that contribute to the comfort of passengers in various modes of transportation. This study aims to identify and understand the key elements, including design features, materials, technologies, and operational considerations, that influence the overall comfort experienced by passengers during transit. By examining these factors, the study intends to provide valuable insights for improving the design, engineering, and operation of transport vehicles to enhance passenger comfort and satisfaction [2].

1.3 FACTORS INFLUENCING RIDE COMFORT

1.3.1 Suspension Systems

A suspension system in a vehicle is a critical component that connects the vehicle body to its wheels. Its primary purpose is to provide a comfortable ride for passengers while ensuring that the tyres maintain good contact with the road surface. A well-designed suspension system also contributes to stability, handling, and control of the vehicle [3].

1.3.1.1 Components of a Suspension System:

- *Springs*: Springs are the foundational element of a suspension system. They absorb shocks and bumps from the road, ensuring that the ride remains smooth. Common types include coil springs, leaf springs, and torsion bars.
- *Dampers (Shock Absorbers)*: Dampers work in conjunction with springs to control the oscillations generated by road irregularities. They absorb and dissipate energy, preventing the suspension from bouncing excessively.
- *Control Arms*: These link the suspension to the chassis and allow for vertical movement of the wheels. They play a crucial role in maintaining wheel alignment.
- *Anti-roll Bars (Sway Bars)*: These are used to reduce body roll during cornering. They connect the suspension components on either side of the vehicle and help distribute forces more evenly.
- *Bushings*: These are small, flexible connectors that reduce friction and absorb shock between different components of the suspension.

1.3.2 Design Considerations

- *Ride Comfort vs. Performance*: Striking a balance between a comfortable ride and sporty handling is crucial. This choice often depends on the intended use of the vehicle. Luxury cars may prioritize comfort, while sports cars focus on performance.
- *Road Conditions*: Suspension design should consider the typical road conditions the vehicle will encounter. Off-road vehicles, for example, require robust, long-travel suspension systems to handle rough terrain.

- *Weight Distribution:* The suspension system must be designed to accommodate the weight distribution of the vehicle, which affects factors like stability and handling.
- *Wheel and Tyre Size:* Larger wheels and tyres can affect the suspension's behavior, requiring adjustments to maintain optimal performance.
- *Adjustability:* Some suspension systems allow for adjustments to be made, allowing drivers to fine-tune the ride characteristics based on their preferences or specific driving conditions.
- *Cost and Manufacturing Constraints:* Designers must balance performance and cost-effectiveness within the constraints of manufacturing capabilities and budget considerations.

Examples:

- *Off-Road Vehicle:* An off-road truck like a Jeep Wrangler requires a robust suspension system with high ground clearance, long-travel shocks, and sturdy components to navigate rugged terrain.
- *Sports Car:* A high-performance sports car like a Porsche 911 prioritizes precise handling and responsive feedback. Its suspension is tuned for tight cornering and minimal body roll.
- *Luxury Sedan:* A luxury sedan like a Mercedes-Benz S-Class emphasizes a plush, comfortable ride. Its suspension system employs advanced dampers and air springs to provide a smooth and refined driving experience.

1.4 DAMPING AND SHOCK ABSORPTION TECHNOLOGIES

Damping and shock absorption technologies are crucial aspects of a vehicle's suspension system. They play a pivotal role in ensuring a comfortable ride, enhancing vehicle stability, and improving handling. These technologies are designed to control the oscillations and vibrations generated by the movement of the wheels over uneven surfaces [4].

1.4.1. Conventional Shock Absorbers

Conventional shock absorbers, also known as hydraulic or telescopic shock absorbers, use hydraulic fluid to dampen and control the motion of the suspension system. They consist of a piston that moves inside a cylinder filled with hydraulic fluid. The Monroe OE Spectrum Shock Absorber is a well-known conventional shock absorber that provides consistent performance and comfort for various types of vehicles.

1.4.2. Gas-Charged Shock Absorbers

Gas-charged shock absorbers incorporate a high-pressure gas (usually nitrogen) along with hydraulic fluid. This combination minimizes aeration and foaming of the fluid, resulting in improved damping performance and responsiveness. The Bilstein B8 5100

Series Shock Absorber is a popular gas-charged shock absorber known for its superior damping capabilities, making it suitable for both on-road and off-road applications.

1.4.3. Twin-Tube vs. Mono-Tube Shock Absorbers

- i) Twin-tube shock absorbers feature two cylindrical chambers—one inner and one outer. The inner chamber houses the piston, while the outer chamber contains the hydraulic fluid. This design allows for better heat dissipation.
- ii) Mono-tube shock absorbers have a single cylindrical chamber that houses both the piston and the hydraulic fluid. They offer a simpler design and can provide more consistent damping in extreme conditions.

1.4.4. Electronic Adaptive Damping

Electronic adaptive damping systems utilize sensors to continuously monitor various vehicle parameters, including wheel speed, steering input, and more. This information is processed by a control unit that adjusts the damping rates in real time.

The Magnetite suspension system, found in various vehicles including some Audi and Cadillac models, is a notable example of electronic adaptive damping. It offers rapid adjustments to provide a balance between ride comfort and handling performance.

1.4.5. Air Suspension Systems

Air suspension systems replace traditional coil or leaf springs with air-filled bags. These bags are pressurized to support the vehicle's weight. The air pressure can be adjusted to control ride height and stiffness.

The Mercedes-Benz AIRMATIC suspension is a well-regarded air suspension system that allows drivers to choose between comfort and sport modes for a tailored ride experience.

1.4.6. Semi-Active and Active Suspension

Semi-active suspension systems use electronically controlled dampers that can adjust their damping rates based on driving conditions. These systems offer a balance between comfort and performance.

Active suspension systems take it a step further by incorporating additional actuators and sensors to actively control wheel and body movements, providing an exceptional level of ride quality and handling precision e.g.;

1.4.6.1 Porsche Active Suspension Management (PASM): Porsche's PASM system is an adaptive damping system that continuously adjusts damper forces based on driving conditions. It enhances both comfort and performance, allowing the driver to select different modes (e.g., Comfort, Sport).

1.4.6.2 Tesla Model S Air Suspension: The Tesla Model S features an air suspension system that allows the driver to adjust ride height. It offers a comfortable ride in

standard mode and can be lowered for improved aerodynamics or raised for added ground clearance.

1.5 TYRE CHARACTERISTICS AND IMPACT ON COMFORT

Tyre characteristics play a pivotal role in determining the comfort levels of a vehicle. The right combination of tyre attributes can significantly enhance ride quality by effectively absorbing shocks, reducing noise, and providing a smoother driving experience [5].

1.5.1. Tyre Size and Aspect Ratio

The size and aspect ratio of a tyre refer to its dimensions in terms of width, height, and diameter. These factors influence how the tyre interacts with the road surface and affects comfort.

A tyre with a lower aspect ratio (shorter sidewalls) and larger diameter may provide a sportier feel and better handling, but it can transmit more road imperfections to the cabin, potentially reducing comfort.

1.5.2. Tyre Tread Pattern

The tread pattern of a tyre refers to the design of the grooves and channels on its surface. It impacts traction, noise levels, and how well the tyre handles different road conditions. All season tyres typically have symmetrical or asymmetrical tread patterns that strike a balance between traction, comfort, and longevity. They perform well in a variety of driving conditions.

1.5.3. Tyre Compound and Construction

The tyre compound, which is the blend of rubber and other materials, along with its internal construction, affects factors like grip, rolling resistance, and shock absorption. High-performance tyres often use a softer rubber compound to maximize traction and handling. While this can enhance performance, it may lead to a firmer ride compared to standard all-season tyres.

1.5.4. Tyre Pressure

Proper tyre pressure is crucial for maintaining comfort. Underinflated tyres can lead to a harsh ride due to increased sidewall flex, while overinflated tyres can transmit more road irregularities. Manufacturer-recommended tyre pressure can usually be found on a sticker inside the driver's side door jamb. It's important to regularly check and adjust tyre pressure for optimal comfort.

1.5.5. Run-Flat Tyres

Run-flat tyres are designed to allow a vehicle to continue driving even after a puncture or loss of tyre pressure. They typically have reinforced sidewalls to support the weight of the vehicle. The Bridgestone Drive Guard is an example of a run-flat tyre. It offers the convenience of continued driving for a limited distance after a puncture, providing peace of mind for drivers.

1.5.6. Noise Reduction Technology

Some tyres are equipped with noise-reducing features, such as special tread patterns, to minimize road noise. This contributes to a quieter and more comfortable cabin environment. The Michelin Primacy MXM4 is known for its advanced technology that reduces road noise, providing a quieter and more comfortable ride.

1.5.7. Comfort-Oriented Tyres

Some tyre models are specifically designed with a focus on comfort. They may incorporate features like extra sidewall cushioning or a softer compound for a smoother ride. The Continental Conti Pro Contact is a tyre known for its emphasis on comfort. It offers a balance of ride quality, handling, and long tread life.

1.6 VEHICLE DYNAMICS AND INERTIA EFFECTS

Vehicle dynamics refer to the study of how a vehicle moves and responds to external forces, including acceleration, braking, and cornering. Inertia, on the other hand, is a property of matter that resists changes in motion. In the context of vehicles, inertia effects play a crucial role in determining how a vehicle behaves under different driving conditions [6].

1.6.1. Inertia and Acceleration

Inertia affects how a vehicle responds to changes in speed. It is the reason why a vehicle resists changes in its state of motion. When a driver accelerates, the vehicle's mass resists the change, causing it to "lag" behind the acceleration force.

When stepping on the gas pedal, a heavy vehicle will take longer to reach a certain speed compared to a lighter vehicle with the same engine power. This is due to the heavier vehicle's greater inertia.

1.6.2. Inertia and Braking

Inertia also plays a significant role in braking. When the brakes are applied, the vehicle's forward motion wants to continue due to its inertia. This can lead to effects like nose dive or weight transfer to the front of the vehicle. In emergency braking situations, a vehicle with a higher mass will experience more pronounced weight transfer to the front, potentially causing the rear wheels to lift slightly off the ground.

1.6.3. Cornering and Centripetal Force

Inertia affects how a vehicle handles corners. When a vehicle turns, it experiences a centripetal force that tries to push it outward. The vehicle's inertia resists this force, influencing how it negotiates the turn. A vehicle with a higher mass will have more inertia, which can result in a greater resistance to the centripetal force during cornering. This may lead to a sensation of body roll.

1.6.4. Roll and Pitch

Inertia is responsible for roll (side-to-side motion) and pitch (front-to-back motion) effects in a vehicle. These motions are influenced by factors like weight distribution and suspension design.

A vehicle with a higher center of gravity, such as an SUV, will experience more noticeable body roll during cornering due to the greater inertia acting at a higher point.

1.6.5. Steering Response

Inertia affects how quickly a vehicle responds to steering inputs. Heavier vehicles typically have slower steering responses due to their greater inertia.

A sports car, which is designed for nimble and responsive handling, will generally have lower inertia compared to a larger, heavier SUV. This allows for quicker changes in direction.

1.6.6. Impact on Fuel Efficiency

Inertia also has implications for fuel efficiency. Heavier vehicles tend to have higher inertia, which means they require more energy to accelerate and decelerate. This can impact overall fuel consumption.

A lightweight hybrid vehicle with regenerative braking capabilities can capitalize on lower inertia to enhance fuel efficiency, particularly in stop-and-go traffic scenarios.

Understanding the interplay between vehicle dynamics and inertia effects is crucial for designing vehicles that offer optimal performance, handling, and safety across various driving conditions. It also informs decisions related to vehicle weight, suspension tuning, and overall engineering.

1.7 ROAD SURFACE INTERACTION AND PAVEMENT QUALITY

The interaction between a vehicle and the road surface is a critical aspect of vehicle dynamics and ride comfort. The condition and quality of the pavement significantly influence how a vehicle handles, how comfortable the ride is, and how efficiently it operates [7].

1.7.1. Pavement Quality and Ride Comfort

The smoothness and evenness of the road surface directly impact ride comfort. A well-maintained, high-quality pavement provides a smoother ride experience for passengers, reducing discomfort and fatigue. Driving on a newly resurfaced highway with a smooth, freshly laid asphalt surface provides a markedly more comfortable ride compared to a pothole-ridden road with uneven surfaces.

1.7.2. Traction and Handling

The texture and grip of the road surface affect a vehicle's traction and handling capabilities. A high-quality pavement with good traction allows for better control during acceleration, braking, and cornering. On a well-maintained, dry, and clean asphalt road, a vehicle can achieve better traction and responsiveness, leading to improved handling compared to a worn-out, slippery surface.

1.7.3. Pavement Defects and Suspension Stress

Poor pavement quality, characterized by defects like potholes, cracks, and uneven surfaces, can subject a vehicle's suspension system to increased stress. This can lead to accelerated wear and tear on suspension components. Driving over a pothole or a rough section of road can cause sudden jolts and impacts on the suspension system, potentially leading to damage or reduced longevity of components.

1.7.4. Noise and Vibration Levels

The quality of the road surface affects the levels of noise and vibration experienced by passengers. A smooth, well-maintained pavement reduces road-induced noise and minimizes the transmission of vibrations into the vehicle cabin. Driving on a freshly paved highway with low tyre noise and minimal vibration compared to a worn-out road with a rough surface and audible tyre noise.

1.7.5. Road Surface Material and Tyre Wear

The composition of the road surface material can impact tyre wear rates. High-quality pavements with well-compacted and durable materials tend to cause less abrasion on tyres. Driving on a high-quality, well-maintained concrete road is likely to result in less tyre wear compared to driving on a gravel road, where the abrasive nature of loose stones can accelerate tyre degradation.

1.7.6. Effect on Fuel Efficiency

Pavement quality plays a role in a vehicle's fuel efficiency. A smooth, well-maintained road allows for more efficient operation with reduced rolling resistance, which can contribute to better fuel economy. Driving on a well-paved, even surface can lead to improved fuel efficiency compared to navigating a rough, uneven road where the vehicle expends more energy to maintain speed.

1.7.7. Safety Considerations

A high-quality road surface with proper markings and clear signage enhances road safety. It provides better visibility, reduces the risk of skidding or loss of control, and minimizes the likelihood of accidents. A well-maintained, properly marked highway with clear lane divisions and visible road signs contributes to a safer driving environment compared to a poorly maintained road with faded markings and obscured signs.

Optimizing pavement quality is crucial for ensuring safe, comfortable, and efficient travel for both passengers and vehicles. Regular maintenance and proper construction techniques are essential in maintaining high-quality road surfaces.

1.8 INTERIOR LAYOUT, SEATING, AND ERGONOMICS

The interior of a vehicle is designed with careful consideration of user comfort, convenience, and safety. This encompasses the arrangement of seats, controls, storage, and other features to create an ergonomic and user-friendly environment [8].

1.8.1. Seat Arrangement and Configuration

The arrangement and configuration of seats within a vehicle can vary based on the vehicle type and purpose. This includes factors like the number of seats, their positioning, and their ability to be adjusted or folded to optimize passenger space. A family SUV typically has a 2+3+2 seating arrangement to accommodate seven passengers, while a sports car might have a 2-seater configuration for a driver and a passenger.

1.8.2. Ergonomic Design

Ergonomics focuses on designing the interior to maximize comfort and minimize physical strain for occupants. This involves the placement of controls, displays, and seating to accommodate the natural movements and postures of the human body. Placing the steering wheel and pedals at the correct height and angle ensures that the driver can comfortably reach and operate them without straining.

1.8.3. Driver's Cockpit

The driver's cockpit is designed to optimize the driver's experience and control over the vehicle. This includes the placement of steering wheels, pedals, gear shifters, and instrumentation. In a modern sedan, the driver's cockpit is typically designed to provide easy access to controls, clear visibility of instruments, and a comfortable driving position.

1.8.4. Seating Comfort and Adjustability

Seats are designed to provide comfort during extended periods of use. This includes factors like cushioning, lumbar support, and the ability to adjust seat position, angle, and height. Luxury vehicles often come equipped with seats that have multiple adjustable features, including heating, ventilation, and massage functions.

1.8.5. Material Selection

The choice of materials for interior surfaces affects both aesthetics and comfort. This includes options like leather, cloth, synthetic materials, and high-quality plastics. Premium vehicles may feature leather upholstery, providing a luxurious feel and enhanced comfort compared to standard cloth seats.

1.8.6. Storage and Convenience Features

Interior layouts include storage compartments, cup holders, and other features for convenient stowage of personal items and accessories. An SUV might offer fold-down rear seats to create a flat cargo area for transporting large items, enhancing the vehicle's versatility.

1.8.7. User Interface and Infotainment

The layout of controls, displays, and infotainment systems should be intuitive and easily accessible to occupants. A modern vehicle may feature a touch screen infotainment system with user-friendly menus, voice commands, and steering wheel-mounted controls for ease of use.

1.8.8. Safety Considerations

The layout should prioritize safety, ensuring that essential controls and displays are within easy reach and that airbags and safety features are strategically positioned. Essential safety features like airbags, seat belts, and electronic stability control systems are integrated into the interior layout to protect occupants in the event of an accident.

A well-designed interior layout, seating arrangement, and ergonomic features contribute to a comfortable, user-friendly, and safe driving experience. Manufacturers aim to strike a balance between aesthetics, functionality, and user comfort in their vehicle designs.

1.9 NOISE, VIBRATION AND HARSHNESS (NVH) CONSIDERATIONS

NVH is a critical aspect of vehicle design that focuses on minimizing unwanted noise, vibrations, and harshness to enhance comfort, safety, and overall driving experience [9].

1.9.1. Noise Control

Noise control involves reducing unwanted sounds generated by various vehicle components, road conditions, and external factors. This includes engine noise, wind

noise, tyre noise, and other sources of unwanted sound. Sound insulation materials like acoustic foam, dampers, and sound-deadening panels are used in vehicle construction to reduce noise levels.

1.9.2. Vibration Damping

Vibration damping is the process of minimizing the oscillations and vibrations generated by vehicle components, especially the engine and drivetrain. This helps maintain a smoother and more comfortable ride.

The use of engine mounts, isolators, and tuned suspension systems helps absorb and dissipate vibrations before they reach the cabin.

1.9.3. Harshness Reduction

Harshness refers to the perception of discomfort or roughness experienced by occupants due to excessive vibrations or sudden jolts. It involves reducing the intensity of shocks and impacts felt inside the vehicle.

Advanced suspension systems, shock absorbers, and bushings are designed to absorb and cushion against sudden jolts or impacts.

1.9.4. Aerodynamic Noise Control

Vehicle aerodynamics play a crucial role in minimizing wind noise generated by airflow around the vehicle. Streamlined designs and aerodynamic features are implemented to reduce turbulence and associated noise.

Smooth contours, properly designed side mirrors, and aerodynamic body elements help reduce wind noise at high speeds.

1.9.5. Engine and Power Train Refinement

Engineers focus on refining the design and operation of engines and power train to reduce noise and vibration levels. This includes optimizing engine mounts, exhaust systems, and transmission components.

The use of balance shafts in engines helps counteract internal vibrations, resulting in smoother and quieter operation.

1.9.6. Material Selection

NVH considerations extend to the choice of materials used in vehicle construction. Materials with sound-absorbing properties and high structural integrity are selected to minimize noise transmission.

High-quality acoustic materials in the headliner, door panels, and carpeting can significantly reduce interior noise levels.

1.9.7. Suspension Tuning

The suspension system is fine-tuned to strike a balance between comfort and performance. This involves selecting appropriate shock absorbers, springs, and bushings to absorb road irregularities.

Premium vehicles may feature adjustable suspension settings that allow drivers to customize ride comfort based on their preferences.

1.9.8. Component Isolation

Components prone to generating vibrations or noise, such as exhaust systems or power train elements, are isolated from the vehicle's structure to prevent their transmission into the cabin.

Rubber isolators and flexible mountings are used to absorb and dissipate vibrations generated by engine and exhaust system components.

1.9.9. NVH Testing and Analysis

Engineers employ sophisticated testing techniques, such as modal analysis and sound intensity measurements, to identify and address specific sources of noise, vibration, and harshness.

In a testing scenario, engineers might use accelerometers and microphones to measure and analyze the frequency and amplitude of vibrations and noise in different vehicle components.

By addressing NVH considerations during the design and engineering process, manufacturers aim to create vehicles that offer a quiet, smooth, and comfortable ride, enhancing the overall driving experience for occupants.

1.10 CLIMATE CONTROL AND VENTILATION SYSTEMS

Ride comfort in vehicles is influenced by various environmental factors that encompass both natural and man-made elements. The interaction between a vehicle and its environment significantly impacts the overall comfort experienced by passengers. Addressing these environmental factors is crucial for automotive engineers and designers aiming to create vehicles that provide a smooth and enjoyable ride while minimizing the impact on the environment. Key environmental factors influencing ride comfort include road conditions, weather, and noise pollution [10].

1.10.1 Road Conditions:

Road conditions are a primary environmental factor affecting ride comfort. The quality of the road surface, including smoothness, potholes, and irregularities, directly influences the vibrations transmitted to the vehicle. Well-maintained roads with even surfaces contribute to a smoother ride, while deteriorated or uneven roads can result in a bumpier experience. Engineers address these challenges through advanced suspension

systems, shock absorbers, and tyre technologies designed to absorb and dampen road-induced vibrations.

1.10.2 Weather Conditions and their Impact on Ride Comfort

1.10.2.1 Weather Conditions: Weather conditions play a significant role in determining ride comfort, especially in open-air or convertible vehicles. Rain, snow, and extreme temperatures can affect visibility, traction, and overall driving dynamics. The design of convertible vehicles, for instance, must consider factors such as water ingress and wind noise. Additionally, adverse weather conditions can impact road surfaces, leading to reduced grip and potentially affecting ride quality. Advanced climate control systems and weather-resistant materials are employed to mitigate these effects, ensuring a comfortable environment for passengers in various weather conditions.

1.10.2.2 Temperature and Climate: Extreme temperatures, whether hot or cold, can influence the comfort inside a vehicle. In hot climates, efficient air conditioning systems and sun-reflective materials help maintain a comfortable interior temperature. In cold climates, effective heating systems and insulated materials contribute to passenger well-being. The integration of advanced climate control technologies, including seat heating and ventilation, further enhances the ability to create a comfortable interior environment regardless of external temperature extremes.

1.10.2.3 Urban Environments: The nature of the driving environment, whether urban or rural, influences ride comfort. Urban environments are often characterized by traffic congestion, stop-and-go driving, and frequent changes in speed. These conditions can lead to increased stress for drivers and passengers, affecting the overall comfort of the ride. Automotive technologies such as adaptive cruise control, automatic emergency braking, and traffic-aware navigation systems aim to mitigate these challenges, providing a smoother and less stressful driving experience in urban settings.

1.10.2.4 Environmental Sustainability: Considering the broader context of environmental sustainability, manufacturers are increasingly incorporating eco-friendly materials and technologies in vehicle design. This includes the use of recycled materials, energy-efficient manufacturing processes, and the development of electric and hybrid vehicles with lower emissions. These initiatives not only contribute to environmental conservation but also align with the growing consumer demand for eco-conscious and socially responsible transportation options.

Therefore ride comfort in vehicles is intricately linked to various environmental factors, ranging from road conditions and weather to noise pollution and the overall driving environment. Addressing these factors requires a combination of advanced engineering solutions, innovative technologies, and a commitment to environmental sustainability.

As the automotive industry continues to evolve, the integration of eco-friendly practices and cutting-edge technologies will play a vital role in enhancing ride comfort while minimizing the environmental impact of vehicular transportation.

1.11 ADVANCED SUSPENSION SYSTEMS AND ACTIVE DAMPING TECHNOLOGIES

Advanced suspension systems and active damping technologies represent a crucial frontier in automotive engineering, contributing significantly to the ride comfort, handling, and overall performance of vehicles. Traditional passive suspension systems have evolved into sophisticated setups that dynamically respond to changing road conditions, ensuring a smoother and more controlled driving experience. This comprehensive exploration will delve into the key features, innovations, and benefits of advanced suspension systems and active damping technologies [11].

1.11.1 Evolution from Passive to Active

Historically, suspension systems primarily relied on passive components like springs and dampers to absorb shocks and vibrations. The evolution towards active suspension systems involves the integration of sensors, actuators, and advanced control algorithms. Active damping technologies go a step further by dynamically adjusting damping forces in real-time, allowing for optimal handling and comfort in various driving conditions.

1.11.2 Key Features and Components of Advanced Suspension Systems

1.11.2.1 Adaptive Damping: One of the key features of advanced suspension systems is adaptive damping, which allows for the real-time adjustment of damping forces based on driving conditions. This technology employs sensors to continuously monitor factors such as road surface, vehicle speed, and driver input. The control system then adjusts the damping forces accordingly, providing an optimal balance between ride comfort and handling performance.

1.11.2.2 Air Suspension: Air suspension systems have gained prominence in advanced suspension setups. These systems replace traditional coil springs with air springs, allowing for variable ride height and load-leveling capabilities. Air suspension provides a smoother ride and the ability to adjust the vehicle's height based on driving conditions, enhancing comfort and aerodynamics.

1.11.3 Innovations in Active Damping Technologies

1.11.3.1 Magnetic Ride Control: Magnetic Ride Control, developed by Delphi Automotive and later utilized by various automakers, is a groundbreaking technology that utilizes magneto rheological fluid in the shock absorbers. This fluid's viscosity can be rapidly altered by applying a magnetic field, enabling precise and instantaneous

adjustments to the damping rates. This technology enhances both ride comfort and handling performance, adapting to changing road conditions within milliseconds.

1.11.3.2 Electronically Controlled Dampers: Advanced suspension systems often incorporate electronically controlled dampers that replace traditional shock absorbers. These dampers can be adjusted independently for each wheel, allowing for a more tailored response to different road conditions. With electronic control, the damping characteristics can be fine-tuned based on sensor inputs and driver preferences, providing a customizable and adaptive solution.

1.11.4 Benefits of Advanced Suspension Systems

1.11.4.1 Improved Ride Comfort: One of the primary benefits of advanced suspension systems is the substantial improvement in ride comfort. The ability to adapt to varying road conditions and absorb shocks more effectively ensures that occupants experience a smoother and more comfortable ride, even on uneven or rough surfaces.

1.11.4.2 Enhanced Handling and Stability: Advanced suspension systems contribute to enhanced handling and stability. The dynamic adjustment of damping forces and other parameters optimizes tyre contact with the road, improving grip and responsiveness. This, in turn, leads to better cornering performance, reduced body roll, and an overall more enjoyable driving experience.

1.11.5 Applications and Industry Trends

1.11.5.1 Performance and Sports Cars: Advanced suspension systems are often a staple in high-performance and sports cars, where precise handling and ride comfort are paramount. Manufacturers of luxury and sports vehicles leverage these technologies to differentiate their offerings and provide a superior driving experience.

1.11.5.2 Off-Road Vehicles and SUVs: In the realm of off-road vehicles and SUVs, advanced suspension systems, including adaptive damping and air suspension, have become instrumental. These technologies allow for increased versatility, enabling these vehicles to handle both on-road and off-road conditions with ease.

1.11.6 Future Prospects and Conclusion

1.11.6.1 Autonomous Vehicles: As the automotive industry progresses towards autonomous vehicles, the role of advanced suspension systems becomes even more critical. These systems will need to adapt not only to the driving conditions but also to the preferences and comfort of passengers in an autonomous setting.

Integration with Smart Technologies: The future of advanced suspension systems involves integration with smart technologies. Collaborations with artificial intelligence and machine learning algorithms can enhance the predictive capabilities of these systems, allowing for more anticipatory and proactive adjustments based on historical data and real-time conditions.

It can be summarized that advanced suspension systems and active damping technologies represent a pinnacle in automotive engineering, continually pushing the boundaries of ride comfort, handling, and performance. With ongoing innovations and a growing focus on smart, adaptive solutions, these technologies are set to play a central role in defining the driving experience of future vehicles.

1.12 SMART TYRE TECHNOLOGIES AND ADAPTIVE TYRE PRESSURE SYSTEMS

In the ever-evolving landscape of automotive technology, the focus on safety and efficiency has led to the development of innovative solutions for monitoring and managing tyre pressure. This section explores the significance of smart tyre technologies and adaptive tyre pressure systems in addressing the critical issue of improper tyre pressure. Beyond the traditional considerations of safety, maintaining the appropriate tyre pressure is recognized as a key factor influencing fuel efficiency, tyre lifespan, and overall vehicle performance. Proper tyre pressure is essential for ensuring vehicle safety and performance. Under-inflated or over-inflated tyres can compromise traction, handling, and braking capabilities, leading to increased risks of accidents. Additionally, improperly inflated tyres contribute to decreased fuel efficiency and can accelerate tyre wear, impacting the overall cost of vehicle ownership. Recognizing the importance of maintaining optimal tyre pressure, the integration of smart tyre technologies becomes a significant advancement in modern vehicle systems [12].

1.12.1 Smart Tyre Technologies

1.12.1.1 Tyre Pressure Monitoring System (TPMS): A cornerstone of smart tyre technologies is the Tyre Pressure Monitoring System (TPMS), designed to continuously monitor tyre pressure and alert drivers to deviations from the recommended levels. TPMS utilizes sensors placed within each tyre to measure pressure and, in some advanced systems, temperature. When a deviation is detected, the system triggers a warning, typically displayed on the vehicle's dashboard. TPMS enhances safety by providing real-time information about tyre conditions, allowing drivers to take prompt corrective action.

1.12.1.2 Integration with Android Phone: To further enhance user engagement and convenience, smart tyre technologies are integrating with Android phones. The seamless connection between TPMS and Android devices enables users to receive real-time tyre pressure updates directly on their smartphones. This integration is facilitated through the Serial Port Bluetooth Profile (SPP), ensuring reliable communication between the TPMS sensors and the Android phone. This level of connectivity brings tyre pressure monitoring into the digital realm, offering users instant access to vital information.



Fig.1.1. Tyre Pressure Monitoring System (TPMS) using Android app

1.12.2 Adaptive Tyre Pressure Systems and Conclusion

1.12.2.1 Color-Coded Indications and Notifications: To make tyre pressure information more accessible and user-friendly, adaptive tyre pressure systems incorporate color-coded indications and notifications. In this approach, users receive visual cues on their Android phones, using a color scheme to represent different tyre pressure states. Green indicates optimal pressure, yellow signals a slight deviation, and red signifies a critical deviation requiring immediate attention. These color-coded notifications allow users to quickly assess the tyre status, promoting proactive maintenance and minimizing the risk of accidents due to improper tyre pressure.

1.12.2.2 Benefits and Conclusion: The adoption of smart tyre technologies and adaptive tyre pressure systems brings a multitude of benefits to vehicle owners. Enhanced safety through real-time monitoring, improved fuel efficiency, extended tyre lifespan, and simplified maintenance are among the advantages. By integrating these systems with Android phones, the accessibility and user engagement are elevated, fostering a more connected and informed driving experience. As automotive technology continues to progress, the integration of smart solutions for tyre management represents a noteworthy stride towards safer, more efficient, and technologically advanced vehicles. The proposed combination of TPMS with Android connectivity exemplifies the synergy between traditional safety concerns and contemporary digital solutions in the pursuit of optimal vehicle performance.

1.13 VEHICLE DYNAMICS CONTROL SYSTEMS FOR ENHANCED COMFORT

In the pursuit of safer, more comfortable, and technologically advanced vehicles, the integration of sophisticated vehicle dynamics control systems has become a key focus in the automotive industry. This section delves into the advancements in vehicle dynamics control, specifically targeting brake, steering, and suspension systems. As vehicles become more complex, the development of these systems requires specialized expertise, with groups like the Automotive Systems Group, led by Hitachi, Ltd., actively contributing to the evolution of vehicle dynamics control for enhanced comfort and performance [13].

1.13.1 Evolution of Vehicle Dynamics Control

Vehicle dynamics control systems have evolved from traditional, mechanically controlled components to advanced, electronically controlled systems. These systems play a crucial role in optimizing vehicle behavior under various driving conditions, ensuring stability, responsiveness, and comfort. As vehicles incorporate more technology and move towards semi-autonomous driving, the role of vehicle dynamics control becomes increasingly pivotal.

1.13.2 Categorization of Vehicle Dynamics Control Systems

1.13.2.1 Brake Systems: Advanced brake systems are a fundamental component of vehicle dynamics control. Anti-lock Braking Systems (ABS), Electronic Brakeforce Distribution (EBD), and Brake Assist systems contribute to safer and more controlled braking. These systems not only prevent wheel lockup during emergency braking but also distribute braking force optimally among the wheels, enhancing stability and control.

1.13.2.2 Steering Systems: Electronic Power Steering (EPS) and advanced steering assist systems contribute to precise and responsive vehicle handling. EPS provides variable assistance based on driving conditions, improving maneuverability at low speeds and offering stability at high speeds. Steering assist systems further enhance driver control by adjusting steering inputs based on factors such as lane-keeping and driver behavior.

1.13.3 Advancements in Suspension Systems and x-by-wire Technologies

1.13.3.1 Suspension Systems: Vehicle dynamics control extends to suspension systems, where advancements aim to provide a smoother and more comfortable ride. Active suspension systems, such as adaptive dampers and air suspensions, dynamically adjust the vehicle's suspension settings based on real-time driving conditions. These results in improved ride comfort, reduced body roll, and enhanced overall stability.

1.13.3.2 X-by-wire Technologies: The development of x-by-wire technologies is a pioneering step in vehicle dynamics control. This encompasses brake-by-wire, steer-by-

wire, and throttle-by-wire systems, where traditional mechanical linkages are replaced by electronic control. Hitachi, Ltd.'s involvement in the development of x-by-wire technologies signifies a commitment to enhancing fundamental vehicle functions. These technologies offer precise control, increased efficiency, and the potential for innovative vehicle architectures, contributing to a more dynamic and responsive driving experience.

1.13.3.3 Role of the Automotive Systems Group: The Automotive Systems Group, with Hitachi, Ltd. at its core, plays a crucial role in advancing vehicle dynamics control. By actively engaging in the utilization of vehicle dynamics control actuation technologies, this group contributes to the development of cutting-edge systems that enhance driving, cornering, and braking functions. As the complexity of these systems increases, collaboration among manufacturers becomes essential, and the Automotive Systems Group exemplifies the collaborative approach required to push the boundaries of vehicle dynamics control.

Thus, the evolution of vehicle dynamics control systems is a testament to the automotive industry's commitment to safety, performance, and comfort. Brake, steering, and suspension systems are integral components, and their continued advancement contributes to a more holistic and integrated approach to vehicle dynamics. The involvement of groups like the Automotive Systems Group highlights the collaborative efforts needed to push the boundaries of technology and create vehicles that offer not just transportation but a truly dynamic and comfortable driving experience.



Fig. 1.2: Vehicle Dynamics Control Unit. Stability control unit with pressure sensor less system and combination hydraulic circuit part and electronic control part (Mass: 1.96 kg)

1.14 VEHICLE DYNAMICS SOFTWARES, TECHNOLOGICAL INNOVATIONS AND ITS ADVANCEMENTS

Vehicle dynamics software plays a pivotal role in the automotive industry, influencing the design, performance, and safety of vehicles. This software encompasses a range of technologies and simulations that analyze and predict the behavior of vehicles under various conditions. Over the years, advancements in vehicle dynamics software have revolutionized the design and engineering processes, contributing to improved ride comfort, handling, and overall safety [14].

Simulation Technologies: One of the key aspects of vehicle dynamics software is its ability to simulate and model the behavior of vehicles in different scenarios. Advanced simulation technologies allow engineers to virtually test and analyze various factors, including suspension systems, tyre performance, aerodynamics, and vehicle stability. These simulations enable a comprehensive understanding of how a vehicle will behave in real-world conditions, helping to optimize design parameters for performance and safety.

Various Vehicle Dynamics Software options are available, including Symbol Shakti Software, Enport Software, Archer Software, Camp-G Software, 20 Sim Software, Pasion 32 Software, Bondlab Software, Cambas Software, Dymola Software, Hybridsim Software, and Modelica Software. A brief overview of each is provided below:

1.14.1 Symbol Shakti Software

The assessment of various software packages is based on the publication by Mukherjee and Samantray (2006). One of the software packages discussed is Symbol Shakti, which is object oriented hierarchical hybrid modeling, simulation, and control analysis software. It provides users with the ability to create models using bond graphs, block diagrams, and equation models. The software offers a wide range of advanced sub-models, referred to as Capsules, tailored for different engineering and modeling domains. It automatically generates fully reduced system equations and effectively resolves differential causalities and algebraic loops through its powerful symbolic solution engine. Additionally, it has the capability to generate high-level C language code and supports embedding of external code. The simulator module includes both online and post-display features, along with event handlers and online event notification. Notably, it allows for variation of parameters, enhancing its versatility. The software also boasts a well-developed controls module that can automatically convert state-space modules from bond graph or block diagram models into analog or digital transfer functions. It is proficient in performing various control and high-level control analyses.

Symbol Shakti incorporates a contemporary Graphical User Interface (GUI) and offers advanced symbolic and numeric solution capabilities. Its iconic modeling feature allows for a system-morphic model layout. The presence of event handlers further enhances its functionality. The software also provides numerous post-processing capabilities for analyzing simulated results. However, it is important to note that this software requires the pre-installation of Microsoft Developer Studio (version 5.0 or above). Its direct C++ compilation feature facilitates seamless integration of external code. The controls module encompasses advanced functionalities for state-space, analog, and digital routines, including conversions, filters, and feedback systems. It handles matrices, transfer functions, quadruples, and numeric data with equal proficiency. The developers highly recommend this software for applications in research and industrial modeling, especially for large systems.

1.14.2 Enport Software

Enport software, developed by Hales and Rosenberg in the early seventies, holds a significant place in bond graph modeling and simulation. Unlike its contemporaries, Enport did not require explicit specification of causalities. Instead, it translated topological input descriptions into a branch admittance matrix, allowing for the handling of structurally singular problems. The current iteration, Enport-7, introduces an alphanumerical topological input language alongside a user-friendly menu-driven graphical interface. While Enport-7 is compatible with various mainframe computers, a slightly streamlined version, Enport/PC, is available for IBM PC's and compatible systems.

This software carries sentimental value for many, having played a crucial role in the advancement of bond graph theory and applications. The new release, Model Builder (MB), supports hierarchical model structuring by defining subsystem components that can encapsulate other components. These components possess display properties, including an icon, which can be utilized in a graphical modeling environment. Additionally, MB structures equations for solution using MATLAB. The latest enhancement to this product comes in the form of User-Defined Model Types (UDMTs), offering generalized model definitions based on multiport templates that can be specialized for specific purposes. The Multiple Document Interfaces (MDI) architecture further solidifies its status as a suitable editing and development environment. However, it's important to note that this product is not available on a commercial scale and may not adhere to contemporary software development standards.

1.14.3 Archer Software

Archer software, developed by Figueiredo et al. (2008), is a product of the "Laboratoires d'Automatique et d'Informatique Industrielle de Lille" (L.A.I.L.) at the Ecole Centrale de Lille. The BG-group within LAIL focuses on applying bond graph theory to create physically consistent models for a wide range of engineering and life

sciences systems. The BG-Group has also developed Archer, a modeling software that allows for structured and graphical development of engineering models. Additionally, the group has advanced methods for fault diagnosis and structural analysis using bond graphs.

Written in VB and C++, Archer is object-oriented and structured. Currently, it is not commercially available. The software enables determination of structural controllability, observability, and inevitability of linear models. While it is a high-quality academic tool centered around automatic control theory, its user interface lacks modern features. However, numerical simulation and control systems analysis are not within the scope of this product.

1.14.4 Camp-G Software

Camp-G software, adopted by Granda (1997), aids engineers and scientists in designing Mechatronics and Dynamic Systems using physical models described through Bond Graphs. It allows for the modeling of mechanical, electrical, hydraulic, thermal, and control systems together using computer graphics. Camp-G serves as a model generating tool that interfaces with languages like MATLAB/SIMULINK, ACSL®, and others for computer simulations of physical and control systems.

The software features a preprocessor with a user-friendly GUI but does not support object-based modeling. The derived equations are not fully reduced or properly sorted. It heavily relies on external software for post-processing, which may result in a loss of relation to the base bond graph model in mathematical abstractions.

1.14.5 20 Sim Software

20 Sim, as developed by Broenink (1995), is a modeling and simulation program designed for Windows. It is an advanced package for dynamic systems modeling and simulation, supporting various modeling approaches including iconic diagrams, bond graphs, block diagrams, and equation models, either individually or in combination. The latest release offers compatibility with SIMULINK/MATLAB for enhanced functionality.

This time-tested modeling tool has evolved from the renowned 20 Sim software and offers valuable sub-modeling capabilities. It supports hierarchical modeling but relies on a somewhat outdated Pre-Defined Model Type (PDMT) object implementation. 20 Sim does not require external compilers or additional post-processing software. However, its control systems analysis module is limited to simulation and basic frequency domain charts. The object property and equation description language may not align with contemporary programming languages like Pascal, FORTRAN, C, or C++. Overall, it is a recommended tool for modeling small to medium-sized systems, although its graphics and hard copy output quality may be subpar. The use of non-

standard menu and toolbar systems, as well as a Single Document Interface (SDI) architecture, may make overall model creation somewhat tedious.

1.14.6 Pasion 32 Software

Pasion 32 Software, extensively explored by Raczynski (2000), is an object-oriented simulation tool capable of handling discrete, continuous, and combined models. It supports various modeling approaches including ODE, signal-flow graphs, bond graphs, queuing models, and 3D animation. This low-cost simulation software is versatile, covering discrete event and continuous system simulation, queuing models, bond graphs, signal flow graphs, 3D animation scenarios, training, and more. The Bond Graph model is created using the user-friendly graphical editor BONDW, eliminating the need for explicit causalities. BGSW (Bond Graph Simulator) generates differential equations for the model, which are then automatically translated into corresponding Pasion code and simulated using the DIFEQ solver module.

Pasion 32 lives up to the reputation of its author which was developed by Stanislaw Raczynski, an editor of the open directory project on scientific simulation software,. It employs an object-oriented, Pascal-related simulation language with a clear process/event structure. The translator generates Pascal source code that can be compiled and executed. The software is capable of both transient process and frequency response simulations, allowing for concurrent operation of state events, discrete and continuous objects. A library of commonly used processes is available, along with a post mortem analyzer for stochastic models. The complex system simulator (CSS) facilitates the coupling of different model types. While hierarchical model building in the bond graph domain may not be advanced, Pasion 32 is recommended for classroom and tutorial use by students and researchers.

1.14.7 Bondlab Software

Bondlab is a design environment developed by Minten et al. (1997) to streamline and optimize the design cycle of mechatronics products. This platform-independent MATLAB toolbox seamlessly integrates behavioral modeling with other tasks in a mechatronics design cycle. It features an easy-to-use model entry graphical interface and provides unified treatment for both linear and nonlinear models. Bondlab supports smooth transitions between behavioral and causal model descriptions, allowing for nonlinear parametric ODE description in MATLAB function format, symbolic and numerical transfer functions, symbolic and numerical nonlinear state space, and parametric Simulink2® .mdl block diagram format. The software also offers direct simulation, visualization, and animation capabilities.

Bondlab's GUI adheres to standard software practices, with ergonomically placed editing tools. It employs a Single Document Interface (SDI) architecture in Win 32,

which may make model building slightly challenging. The software also includes support for bond graph animation. Overall, Bondlab has been rated as average software.

1.14.8 Cambas Software

Cambas, an automated modeling software utilizing Bond Graphs, has been adopted in literature by Moore and Frumkin (2012) from the University of Michigan. System components are represented by icons called templates, each with a fixed number of ports for interconnection. Expandable bond graph models are used to represent the detailed model within each component template. Cambas allows design engineers to select and arrange icons (templates) containing the expandable model to build a representation that matches the system configuration. It then deduces the Proper Model (global system bond graph) based on the eigenvalue structure. The software includes four major components: bond graph processor, system synthesizer, equation generator, and eigenvalue solver. Parameters for each component are entered using the Parameters tool, and the bond graph of any component can be displayed using the Expand tool.

Cambas is developed using the C programming language and OSF/Motif graphics commands for RISC workstations. It facilitates the development of proper models using a two-level, Template-Based Modeling Approach, enhancing dynamic performance during the early stages of design. However, it is applicable only to linear systems, with simulation and control analysis beyond eigenvalue inspection falling outside its scope. Cambas is available as freeware from the Automotive Research Center at the University of Michigan.

1.14.9 Dymola Software

Dymola, developed by Dynasim in 1992, provides object-oriented modeling using the Modelica language. It enables graphical model composition from library models, offers continuous/discrete simulation, and supports 3D animation. Bond graph methodology can also be implemented. Model details are expressed through ordinary differential and algebraic equations, including matrix form. Dymola symbolically converts the differential-algebraic system of equations to state-space form if feasible. Graph-theoretical algorithms are employed to determine which variable to solve for in each equation and to identify minimal systems of equations, potentially employing tearing for simultaneous solution (algebraic loops). The equations are then solved symbolically when possible. Linear systems of equations can be solved symbolically or numerically. Dymola also accommodates instantaneous and discontinuous equations, and it provides readily available model libraries across various engineering domains.

Dymola excels in handling large, complex multi-domain models, offering faster modeling through graphical composition and symbolic pre-processing. It allows user-defined model components, 3D animation, and real-time simulation. The extensive library modules make it a favorable platform for streamlined model creation. Utilizing

the Modelica language supports hierarchical structuring, reuse, and evolution of large and complex models irrespective of the application domain. The main challenge lies in learning the Modelica language. While it lacks provisions for advanced frequency domain and control system analysis, it is highly regarded as a modeling language, though it may not excel in bond graph processing capabilities.

1.14.10 Hybridsim Software

Hybridsim, an implementation of hybrid (mixed continuous/discrete behavior) bond graph modeling and simulation software, was introduced by Mosterman in 2000. It encompasses a set of physical principles governing discontinuous changes in physical system models that may violate the continuity of power constraints. Serving as an experimental modeling and simulation environment, it establishes a formal framework and lays the groundwork for an object-oriented implementation integrated into the Modelica modeling language. This software was crafted using IBM Visual Age for Java. It comprises a model editor and two toolboxes—one for bond graph elements and one for block diagram elements. The simulator is equipped with an animation feature to study power distribution over time.

Hybrid bond graphs extend conventional bond graphs with an ideal switching element, the controlled junction. Simulation is based on graph propagation, bypassing the need for an explicit system of equations. It solely supports ideal bond graph elements and a limited selection of block-diagram components for analyzing small linear systems. The software is still in its development stage, and the Java source code can be downloaded for free.

1.14.11 Modelica Software

Modelica, a language tailored for multi-domain modeling, was developed by Broenink in 2003, under the auspices of a non-profit organization headquartered in Linköping, Sweden. It is an object-oriented modeling and simulation tool, drawing inspiration from concepts found in Dymola. Modelica excels in multi-domain modeling, particularly in applications involving mechanical, electrical, hydraulic, and control subsystems, as well as process-oriented applications and electric power generation and distribution. Models in Modelica are expressed through differential, algebraic, and discrete equations. The language is designed to utilize specialized algorithms for efficient handling of large models, even those with over a hundred thousand equations. Modelica is well-suited for hardware-in-the-loop simulations and embedded control systems.

Several software products, including Dymola, utilize Modelica code for simulation and graphical editing interfaces. The most recent release of the Modelica language, Version 1.4, was made available on December 15, 2000, by the Modelica Association. Modelica accommodates mixed continuous and discrete models (Hybrid models) as well as Discrete Event and Discrete Time Models. It can address conditional equations with

causality changes and generally adopts a formal acausal (non-causal) modeling scheme at the front end. Modelica is well-suited for modeling large systems using a hierarchical modeling scheme, with reusable sub-model classes. However, it may face challenges in terms of GUI drivers and linking with other high-level programming languages like C and C++.

1.15 TECHNOLOGICAL INNOVATIONS IN VEHICLE DYNAMICS SOFTWARE

1.15.1 Real-Time Simulation

Technological advancements in vehicle dynamics software have led to the development of real-time simulation capabilities. This allows engineers to simulate and analyze vehicle behavior in real-time, providing immediate feedback on design changes. Real-time simulations are invaluable in the development of advanced driver assistance systems (ADAS) and autonomous vehicles, where split-second decisions and responses are critical for safety [15].

1.15.2 Integration of Artificial Intelligence (AI)

The integration of artificial intelligence (AI) has brought a new dimension to vehicle dynamics software. AI algorithms can analyze vast amounts of data generated from simulations, vehicle sensors, and real-world testing. This analysis helps in optimizing vehicle dynamics in ways that may be challenging for traditional algorithms. AI is particularly beneficial in developing adaptive systems that can continuously learn and adjust to dynamic driving conditions, enhancing both safety and performance.

1.15.3 Multi-Physics Simulations

Modern vehicle dynamics software has evolved to include multi-physics simulations, allowing engineers to model the interactions between various physical phenomena. This includes the coupling of structural dynamics, fluid dynamics, and thermal analysis. Multi-physics simulations provide a holistic understanding of how different factors, such as aerodynamics and heat dissipation, influence vehicle dynamics. This comprehensive approach is essential for designing vehicles that are not only safe and comfortable but also energy-efficient.

1.16 ADVANCEMENTS IN VEHICLE DYNAMICS SOFTWARE AND FUTURE TRENDS

1.16.1 Autonomous Vehicle Development

The advent of autonomous vehicles has driven significant advancements in vehicle dynamics software. Simulation plays a crucial role in testing and validating the complex algorithms and control systems required for autonomous driving. Vehicle dynamics software allows engineers to create virtual environments where autonomous vehicles

can navigate and respond to a wide range of scenarios, from urban traffic to adverse weather conditions.

1.16.2 Cloud-Based Simulation

Cloud-based simulation is an emerging trend in vehicle dynamics software. This approach leverages the power of cloud computing to perform complex simulations without the need for extensive local computational resources. Cloud-based simulations enable collaboration among global teams, allowing engineers to access and analyze data from anywhere. This not only accelerates the development process but also facilitates knowledge sharing and innovation within the automotive industry.

1.16.3 Cyber security Integration

As vehicles become more connected and reliant on electronic systems, cyber security has become a critical consideration in vehicle dynamics software. Advanced software now includes features to simulate and analyze cyber security threats. This helps engineers identify vulnerabilities in vehicle systems and develop robust security measures to protect against potential cyber-attacks, ensuring the safety and integrity of the vehicle's dynamics and control systems.

1.16.4 Human-Centric Design

Future advancements in vehicle dynamics software are likely to focus on human-centric design, considering the interaction between vehicles and their occupants. Simulations will not only model the physical aspects of vehicle dynamics but also account for human factors, such as driver comfort and perception. This approach will contribute to the development of vehicles that prioritize the well-being and experience of occupants, aligning with the evolving expectations of consumers [16].

The evolution of vehicle dynamics software has witnessed substantial technological advancements, embracing real-time simulations, the integration of artificial intelligence, multi-physics modeling, and the implementation of cloud-based simulations. These progressive developments not only streamline the design and development processes but also significantly contribute to the production of vehicles that are not only safer but also more comfortable and technologically sophisticated. As the automotive industry undergoes continuous transformation, vehicle dynamics software stands as a crucial driver in shaping the future of transportation.

However, for the specific simulation work addressed in this research work, our focus centers on the utilization of Symbol Shakti and MATLAB software. By selecting these software solutions, we aim to leverage their respective capabilities to enhance our understanding of vehicle dynamics and contribute valuable insights to the evolving landscape of automotive engineering. The decision to use Symbol Shakti and MATLAB

reflects a strategic choice based on their features, functionality, and applicability to the objectives outlined in our research.

By adhering to this structured approach, the study aims to offer a comprehensive and insightful analysis of ride comfort in transport vehicles, with the goal of contributing to the ongoing efforts to enhance passenger satisfaction and well-being during transit.

In this research work, it is found that the design criteria for rural road vehicles play a crucial role for rural road conditions characterized by uneven road geometry, including bumps and potholes with displacements of up to 100 mm (0.100 m) in sprung-mass. Specifically, a tyre damping coefficient of ≥ 4 kNs/m is deemed essential for these vehicles to navigate effectively. Furthermore, the objective is to achieve speeds of ≤ 75 km/h, ensuring safe and efficient transportation in challenging rural terrains. An interesting observation is that an increase in the tyre damping coefficient correlates with a decrease in sprung-mass displacement. This relationship underscores the significance of adequate damping in mitigating the impact of uneven road surfaces, thereby enhancing vehicle stability and control.

Moreover, a suspension damping coefficient of ≤ 8 kNs/m is noted to result in higher sprung-mass displacement. While this configuration allows for vehicle speeds above 50 km/h, it is crucial to highlight that the upper limit is set at 75 km/h. This balance in suspension damping is critical to achieving optimal performance on rural roads, striking a delicate equilibrium between speed capability and sprung-mass displacement.

Thus, this research holds pivotal importance in the development of cost-effective and environmentally friendly vehicles tailored specifically for rural road conditions. The emphasis on optimizing damping coefficients not only contributes to the overall efficiency of the vehicles but also aligns with the larger goal of sustainable transportation. This is particularly relevant in the Indian context, where the country's robust economy has historically focused on designing and creating transport vehicles tailored to the unique challenges presented by rural sectors. By addressing the specific demands of rural road conditions, this research aims to facilitate the production of vehicles that not only meet performance criteria but also contribute to the economic and environmental sustainability of rural transportation in India.

CHAPTER 2

LITERATURE REVIEW

2.1 HISTORICAL PERSPECTIVE ON COMFORT RIDE IN TRANSPORT VEHICLES

There has always been trade, human interaction, and transport for almost no society has ever been purely subsistence in character. Expanded trade and the exertion of political power have asked for more, and there have been surges of transport improvements associated with the expansion of empires. Overland and river routes served the trade of Mesopotamia five millennia ago. Roman roads supported Roman hegemony as roads did for Persian, Chinese, and New World rulers. Not much later the grain trade of the Mediterranean flourished, as well as Orient-European linkages. Eventually, Iberian, Dutch, French, and English empires were based on transport and trade. Looking for the thoroughgoing changes in transportation that accompanied the evolution of the modern world, a wave of these were seen in Europe in the centuries just before 1300 where a network of trade centers emerged replacing feudal economies. An explanation for change was the Crusades, which broke the many feudal barriers to movements of individuals and trade. Charlemagne's wandering armies plundering here and there between his soldiers planting and harvesting seasons illustrate the increasing movement by the Ninth Century as barriers were being reduced, often forcefully. His wandering also illustrates that ideas move easily, for in addition to ill gotten loot, Charlemagne returned with ideas about building bridges and large buildings. By the 11th Century road transport had adopted existing technologies such as iron shoes and harnesses for draft animals, swiveling front axles for wagons, and bridge building techniques. But road transport costs were high, coastal and river transport, served most movements. Europe was advantaged because it was and is a well watered peninsula of peninsulas. There were improvements in navigation technologies aiding the ocean trades, ports were chartered by governments and mechanical aids to material handling evolved, and ocean going ships designed mainly for merchant purposes appeared. Portuguese Atlantic ventures began in the 1430s. River improvements began as did the construction of canals. The 1648 Treaty of Westphalia increased access of users to the rivers of Germany. Eventually, extensive canal systems threaded Europe and these were followed by improved road systems incorporating toll roads in many places. Another surge of development began almost 200 years ago when steam engines were applied to water and land transportation. Beginning about 100 years ago, developments building on those

modes followed through to the modern world served by varieties of air, marine, and land transportation.

2.2 THE CONCEPT OF RIDE COMFORT IN TRANSPORT VEHICLES IN EARLY YEARS

It has evolved significantly over the years, influenced by technological advancements, societal changes, and a growing emphasis on passenger well-being. Here is a brief historical perspective on the evolution of ride comfort:

2.2.1 Early Transportation Modes (17th - 19th Century):

2.2.1.1 Horse-Drawn Carriages: In the 17th to 19th centuries, horse-drawn carriages were the primary mode of transportation. Ride comfort was limited, as these carriages had rigid wooden wheels and lacked suspension systems. Passengers experienced a bumpy ride on uneven roads.

2.2.2 Rail Travel (Early 19th Century):

2.2.2.1 Steam Trains: The introduction of steam trains in the early 19th century revolutionized long-distance travel. These trains had iron wheels on iron tracks, which provided a smoother ride compared to horse-drawn carriages. However, the ride was still relatively rough, especially at high speeds.

2.2.3 Automobiles (Late 19th - Early 20th Century):

2.2.3.1 Early Cars: The first automobiles were often little more than a motorized chassis on wagon wheels. The ride was uncomfortable due to the lack of suspension systems. Roads were also typically unpaved, exacerbating the issue.

2.2.4 Advancements in Suspension Systems (Early to Mid-20th Century):

2.2.4.1 Leaf Springs and Shock Absorbers: The early 20th century saw the introduction of leaf springs and shock absorbers, significantly improving ride comfort. Leaf springs allowed the suspension to absorb shocks from bumps in the road, while shock absorbers dampened the oscillations.

2.2.5 Post-WWII Era (Mid-20th Century):

2.2.5.1 Advancements in Materials: With the availability of new materials like rubber and plastics, manufacturers were able to design more effective and comfortable seating. Additionally, advancements in tyre technology further contributed to ride comfort.

2.2.6 Air Travel (Mid-20th Century):

2.2.6.1 Jet Aircraft: With the introduction of jet aircraft, air travel became a popular and viable option for long-distance transportation. The pressurized cabins and advancements in aerodynamics contributed to a smoother and more comfortable flying experience.

2.2.7 Focus on Ergonomics and Comfort (Late 20th Century):

2.2.7.1 Ergonomic Design: Automakers began to prioritize ergonomic design, leading to the development of adjustable seats, lumbar support, and climate control systems. These improvements enhanced passenger comfort during long journeys.

2.2.8 Electronic Controls and Active Suspension (Late 20th - Early 21st Century):

2.2.8.1 Electronic Controls: The integration of electronic systems allowed for adaptive and variable suspension settings, enabling vehicles to adjust to different road conditions and driving styles.

2.2.8.2 Active Suspension Systems: These systems use sensors and electronic controls to continuously adjust the suspension, providing an even smoother ride.

2.2.9 Emergence of Autonomous Vehicles and AI (21st Century):

2.2.9.1 Autonomous Vehicles: The advent of autonomous vehicles promises to further revolutionize ride comfort. With the removal of manual controls and the potential for more sophisticated suspension systems, passengers can experience an even smoother and safer ride.

2.2.10 Sustainability and Comfort (21st Century):

2.2.10.1 Environmental Considerations: With a growing focus on sustainability, manufacturers are exploring eco-friendly materials and lightweight construction techniques that can positively impact both fuel efficiency and ride comfort.

It shows that the historical evolution of ride comfort in transport vehicles reflects a continual pursuit of enhanced passenger well-being and safety. Technological advancements, coupled with a deeper understanding of ergonomics and materials science, have played pivotal roles in shaping the comfort levels we experience in modern transportation. The future promises even more innovations, as the industry embraces new technologies and strives for higher standards of passenger comfort.

2.3 PREVIOUS STUDIES AND RESEARCH FINDINGS ON MODELING OF SIMPLE CAR

Andradottir et al. (1997) offer a comprehensive exposition on simulation modeling and analysis, addressing numerous pivotal inquiries. These include elucidations on the nature of modeling, simulation, and the amalgamation of both in simulation modeling and analysis. Additionally, the paper delves into the realms of problem types amenable to simulation, the criteria for selecting appropriate simulation software, and an insightful exploration of the merits and potential challenges intrinsic to modeling and simulation endeavors. This framework has been embraced as an exemplary model for academic studies [17].

Tseng and Ashrafi (1999) laid the foundation for addressing practical challenges in enhancing technology within vehicle stability control systems. They conducted a thorough examination of diverse approaches to designing and developing automotive systems. These encompass driver intent recognition, vehicle status measurement and estimation, control target generation, optimizing system actuation for efficiency and smoothness, road bank angle detection, as well as system development, evaluation, and fault detection [18]. The operational sequence is illustrated in **Fig. 2.1**.

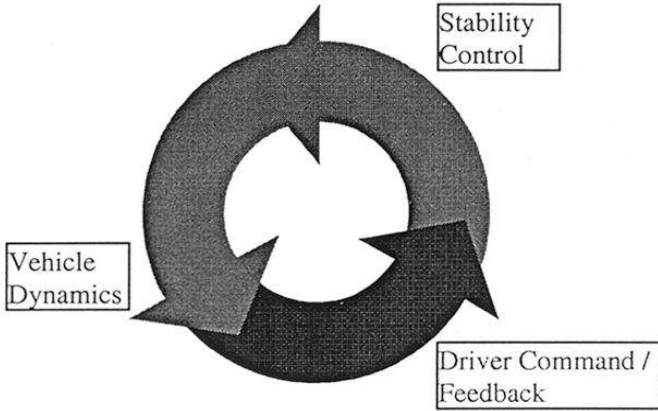

Fig. 2.1 Driver/system/vehicle interaction

Louca et al. (2000) emphasized the importance of establishing a comprehensive model that accurately encompasses the key components of an automobile: the engine, drive train, and vehicle drive systems. The model is constructed with the assumption that it will be subjected to a broad spectrum of excitations, necessitating the inclusion of all potential complexities, such as drive train flexibility and significant rigid body motions. The choice of utilizing Bond graph formulation for model development is driven by its ability to seamlessly integrate component and subsystem models, offer users a clear physical understanding, and facilitate effortless manipulation of the models. Specifically, the engine model operates as a steady-state torque generator, while the drive train encompasses the torque converter, transmission, and driveline. A nonlinear planar model of the vehicle is employed to forecast dynamics in the longitudinal, heave, and pitch degrees of freedom. This model incorporates an international delivery truck within the simulation environment. The integrated vehicle simulation is validated using transient data obtained from real-world proving ground tests. An energy-based model reduction technique is then applied to generate refined vehicle models that offer enhanced design insights. This methodology provides a structured approach to addressing modeling assumptions and creating condensed models that remain valid under specific scenarios. The reduced model, as illustrated in **Fig. 2.2**, yields results remarkably akin to those of the full (baseline) model. Beyond its predictive accuracy, the utility of the reduced model in examining trade-offs related to component redesign

and control strategy enhancements for optimizing vehicle system performance are demonstrated [19].

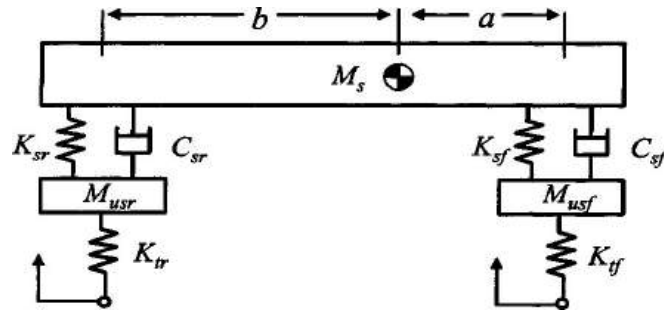

Fig.2.2 Half-car model

Kim et al. (2003) established that Target Cascading in product development is a systematic approach aimed at systematically transmitting the desired top-level system design goals to appropriate specifications for subsystems and components, done in a coherent and efficient manner. When analytical models are available to depict the implications of relevant design choices, this process of Analytical Target Cascading can be formalized as a hierarchical multilevel optimization problem. The article illustrates this intricate modeling and solution procedure within the chassis design of a sport-utility vehicle. Ride quality and handling objectives are propagated down to systems and subsystems employing analysis models for suspension, tyre, and spring components. This methodology allows for the identification of potential conflicts among targets and constraints across the entire system, and enables the quantification of trade-offs involved in attaining system goals under various design scenarios [20].

Kim et al. (2003) outline a comprehensive approach involving hydraulic system design and vehicle dynamic modeling for the advancement of tyre roller traction—a crucial aspect in the analysis of tyre roller systems. Tyre rollers, broadly utilized in road construction, find extensive technical application across various construction domains. The initial phase entails conceptualizing a novel hydraulic driving system and formulating motion equations for dynamic and hydraulic analyses. Specifically, a hydraulic circuit is devised to govern both the steering control and the driving machinery system. This circuit serves to enhance lateral control performance and facilitate the creation of a prototype for construction equipment. Subsequently, models for the hydraulic steering system and hydraulic driving system within the tyre roller system are developed. Finally, the performance data acquired from actual tyre roller equipment, utilizing a data acquisition system, undergoes validation. These findings hold potential to guide the prioritization and design strategies for the incremental integration of tyre roller technology into the realms of vehicles and construction [21].

Maxim and Nguyen (2006) have delved into the modeling of automobile suspensions, a topic of significant interest for automotive and vibration engineers. They place particular emphasis on the ride quality of vehicles navigating uneven terrain and the control of body motion, both crucial concerns for these professionals.

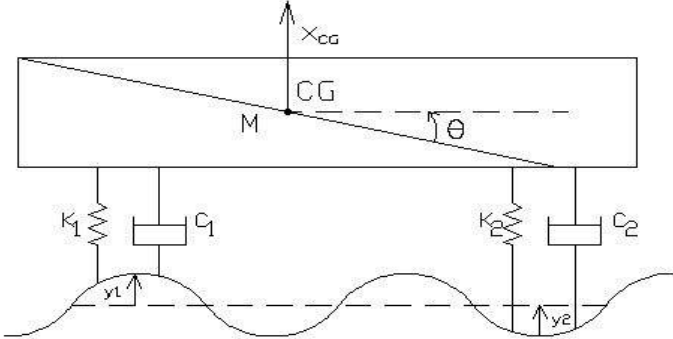

Fig. 2.3 Spring-mass-damper model

When traversing uneven terrain, a vehicle undergoes vertical bounce, pitch (rotation along its length), and roll (rotation along its width) motions. In the modeling process, we assume the vehicle behaves as a rigid body, with its suspension represented as a two-degree-of-freedom (DOF) system. This suspension system encompasses equivalent springs, combining the stiffness of both the tyre and the spring, along with equivalent dampers accounting for the shock absorber and tyre damping. The modeling of the automobile suspension follows a spring-mass-damper model, as illustrated in Fig. 2.3 [22].

Wakeham and Rideout (2011) explore the optimal level of model complexity required for designing effective vehicle active suspension controllers using the Linear Quadratic Regulator (LQR) method. This approach entails formulating a performance index with weighting factors to balance three key objectives in suspension design: suspension travel (rattle space), sprung mass acceleration (ride quality), and tyre deflection (road holding). The optimal control gains are determined through the solution of a matrix Riccati equation, whose dimension corresponds to the number of state variables in the model. A quarter car model with four states poses a less complex formulation challenge compared to a half or full car model, which typically has eight or more states. However, half and full car models are often considered more precise, as they are deemed necessary for capturing and controlling additional degrees of freedom like pitch and roll motion, which aren't directly available in a quarter car model. In this study, both quarter and half car-based controllers are utilized to regulate the vertical acceleration, pitch acceleration, and road holding of a pitch-plane vehicle. Initially, optimal gains are computed for both front and rear actuators, assuming separate quarter-car models with four states for each segment of the vehicle. Subsequently, optimal gains based on a half-car model, utilizing feedback from eight states encompassing the entire vehicle, are

determined. Employing quarter-car-based controllers at both the front and rear of a half-car configuration leads to enhanced performance in mitigating inertial acceleration of the sprung mass. It also proves effective in controlling pitch motion, even in cases where interactions between the front and rear suspensions are not fully decoupled. The reduction of vertical motion at both ends indirectly contributes to the regulation of pitch motion. The benefits arising from the increased complexity of the half-car-based controller become evident primarily when the weighting factor for pitch suppression in the performance index is exceptionally high [23].

In their 2013 work, Mitra A. C. and Benerjee Nilotpal delineate the intricacies of suspension system design, a perennial challenge for automobile designers. This complexity arises from the multitude of control parameters, intricate objectives, and stochastic disturbances. Striking a balance between achieving superior ride comfort and enhancing vehicle handling across diverse driving conditions is imperative for effective suspension design. The inherent conflict between these parameters necessitates a judicious compromise, further complicating the task. This study aims to establish a systematic methodology for determining optimal combinations of suspension damping and stiffness parameters for a ground vehicle subjected to road irregularities. A four-degree-of-freedom (DOF) quarter car model is constructed to analyze the significant effects on passenger body segments (head, thorax-pelvis) while seated on a cushioned seat. Both a Bond graph model and a SIMULINK model are employed, yielding results that are in strong concurrence with one another and aligning with real-world expectations. The investigation delves into the influence of varying suspension stiffness and damping coefficients on ride comfort, road holding, and head displacement across a wide spectrum of road conditions [24].

2.4 MODELING OF FULL CAR WITH SIMPLE SPRING DASHPOT SUSPENSION AND HINGED SUSPENSION

In Glass's 2001 study, an experimental assessment was conducted on a prototype trailing-arm suspension designed for heavy trucks known as the Volvo Optimized Air Suspension-2 (VOAS-2), illustrated in **Fig. 2.4**.

The vehicle was configured in this manner to facilitate kinematic testing of both potential designs, particularly focusing on roll stiffness, without the need to disassemble the vehicle from the testing facility. The trailing-arm spring is secured by a bushing with minimal rotational friction, which limits the suspension's capacity to dissipate energy unless an extra viscous damper is incorporated. This attribute of VOAS-2 proves highly advantageous for regulating suspension damping and enhancing ride quality, leading to improved comfort and reduced harshness in the suspension system [25].



Fig. 2.4 VOAS-2 Suspension on test vehicle.

Rideout et al. (2007) introduce a method for systematically and quantitatively investigating decoupling within elements of a dynamic system model and for segmenting models once decoupling is identified. This technique can verify simplifying assumptions rooted in decoupling, identify instances where decoupling is compromised due to alterations in system parameters or inputs, and highlight necessary model adjustments. The process initiates with the creation of a high-fidelity model utilizing the bond graph formalism. By computing and comparing the power flow measure of the generalized Kirchoff loop and node equations, the respective contributions of the terms are assessed. When there is a negligible aggregate bond power at a constraint equation node, it signifies an extraneous term, which can be eliminated from the model by substituting the associated bond with a modulated source of generalized effort or flow. If replacing all low-power bonds results in separate bond graphs connected by modulating signals, the model can be partitioned into driving and driven subsystems. These partitions are smaller than the original model, possess lower-dimension design variable vectors, and can be simulated independently or in parallel. This partitioning algorithm can be integrated with existing automated modeling techniques to enhance the efficiency and accuracy of simulation-based design for dynamic systems [26].

In 2008, Granda laid the foundation by establishing the fundamental theoretical principles in vehicle dynamics and design. This was complemented by a practical approach utilizing computer-aided techniques, enabling students to construct and analyze vehicle dynamics and mechatronics systems through the use of computer models for analysis and design. The article encompasses a range of topics, including the examination of tyres, drive trains, and gearboxes in ground vehicles, as well as the study of linkages' kinematics for the analysis of position, velocity, and acceleration in both two and three dimensions, with applications to mechanisms, suspensions, and steering systems. Additionally, it delves into vehicle dynamics employing multibody systems in three dimensions, and the creation of computer models for vehicles using solid and

dynamic models. Fig. 2.5 illustrates a typical model of a vehicle system as utilized in the study.

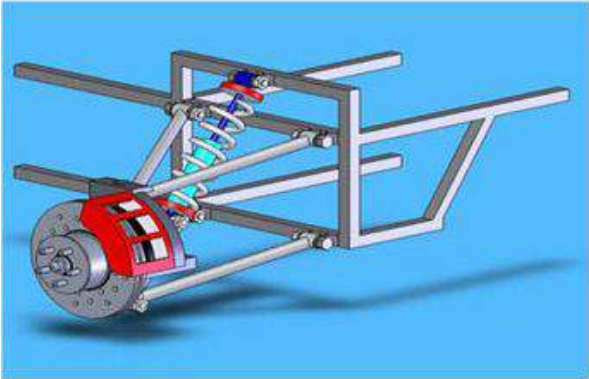

Fig. 2.5 Vehicle systems models

The aim is to equip the student with both analytical and computer-based skills, enabling them to analyze and design components in two and three dimensions, as well as complete working assemblies. Additionally, the training is designed to empower students with the capability to conduct kinematic and kinetic dynamic analyses, Finite Element Analysis, and analyses in both time and frequency domains, among other essential skills [27].

Zoroofi (2008) emphasized that the constraints on the availability of fossil fuels, coupled with their high consumption rate in transportation, necessitate a shift in the vehicle industry towards alternative energy sources. Electric and hybrid vehicles emerge as promising solutions to address this challenge.

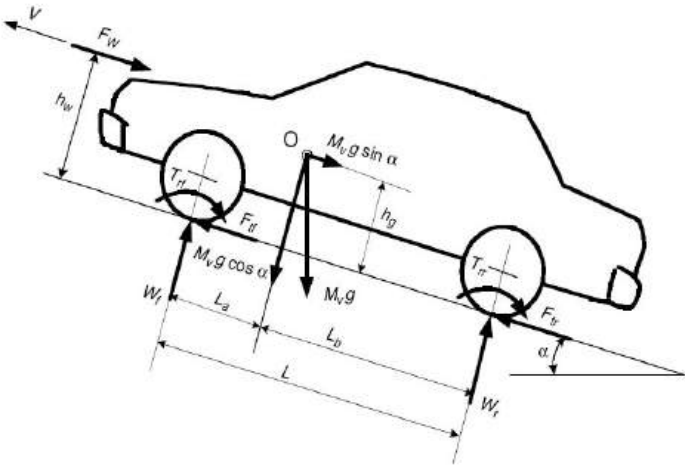

Fig. 2.6 Vehicle longitudinal forces

With advancements in electric motors, power electronics, embedded power train controllers, and energy storage systems like batteries and ultra capacitors, there is

potential for significant improvement in vehicle energy efficiency. However, integrating all these components into a drive train configuration poses challenges for manufacturers. Therefore, utilizing computer simulation and modeling prior to prototyping can offer substantial benefits in terms of cost, safety, and design performance.

The study underscores the valuable role of modeling and simulation in the design process. The accuracy of the battery model was verified through measurements, demonstrating its reliability [28]. Additionally, an illustrative example of modeling longitudinal forces is presented in **Fig. 2.6**.

In their 2008 paper, Silva et al. employ the model-based analytical reduction relationships (ARR) technique, using the Diagnostic Bond Graph, to address the detection and isolation of faults in vehicle suspensions.

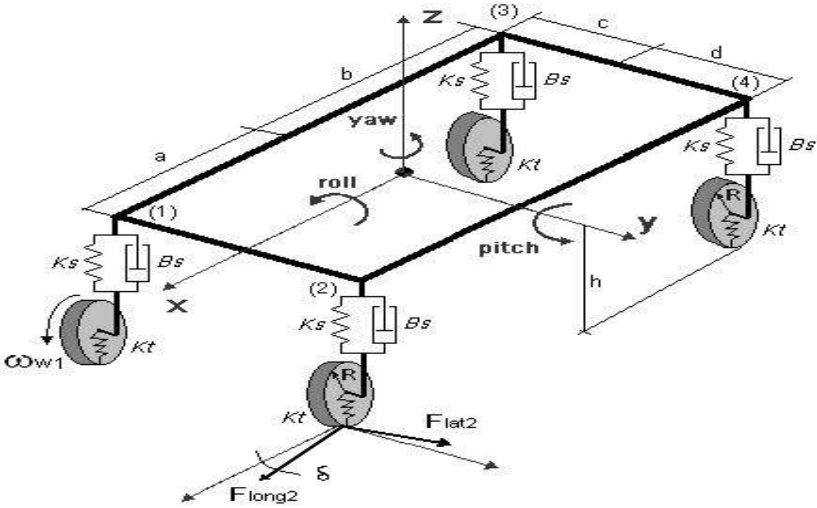

Fig. 2.7 Full car suspension model

The starting point for the study is a Fourteen degrees of freedom (DOF) model of a four-wheeled vehicle, adapted from existing literature models. The key contribution of this paper lies in the introduction of a simplified Diagnostic Bond Graph. This simplified model, based on selected measurements, enables the resolution of the fault detection and isolation (FDI) problem within a reduced subsystem that is decoupled from wheel dynamics. This obviates the need for a complex and uncertain ground-tyre interaction model. The presented simulation results demonstrate the method's efficacy in monitoring and isolating all considered suspension faults [29]. **Fig. 2.7** displays the full car suspension model used.

The study of active suspension systems, as addressed by Adibi and Rideout (2009), has been a subject of significant research over the past two decades. Presently, many commercially available automobiles incorporate active suspension systems. This paper

underscores the advantages of employing the bond graph modeling approach to simulate the capacity of an active suspension system in enhancing ride comfort and handling. An evaluation is conducted comparing active and passive suspension systems using a linearized full car model with seven degrees of freedom. The results indicate a notable reduction in bounce and pitch acceleration, along with some improvement in body roll acceleration for both deterministic and random road profiles. Simulations are conducted using commercial software capable of handling hybrid bond graph and block diagram models, streamlining model construction, simulation, control design, and evaluation within a single software environment [30].

In their 2009 work, Milner et al. introduced a highly detailed six-degree-of-freedom model, developed and validated by the U.S. Army (TACOM-TARDEC). This model was intended for a study focused on the creation of an autonomous vehicle prototype. It accurately captures the dynamic behavior of a six-wheeled, skid-steered vehicle. Additionally, it accounts for the electrical, thermal, and mechanical responses of an intricate series hybrid-electric power system, featuring in-hub drive motors, a lithium-ion battery, and a generator linked to a diesel engine. These components were meticulously modeled and seamlessly integrated through extensive power and energy component libraries, tailored for use with a high-fidelity software tool for dynamics modeling. Furthermore, the vehicle model's entire array of components was integrated in a versatile configuration, allowing for easy adjustments or substitutions. This enabled users to utilize the model in assessing the relative impacts of altering the vehicle's structural or power system elements on specific evaluation criteria. These criteria encompassed aspects such as high-speed stability, skid steering stability, body pitch/roll/dive/squat behavior, braking performance, road/soft-soil traversal, and steering maneuverability.

The model encompasses on- and off-road mobility scenarios, utilizing an extensive library of diverse terrains including hard surfaces, sand, sandy loam, clay soil, and snow. Additionally, it features detailed waypoint-based path navigation routines that automate the vehicle's traversal over a selection of user-defined courses, including established military courses like Churchville-B, Perryman 1, 3, and A, and Munson, with adjustable vehicle speeds. The model operates as an independent executable file, free from reliance on proprietary or closed-source software. Users interact with a simplified interface to adjust variables related to the vehicle's geometry, power system, course and speed preferences, and the type of terrain applied to the course. The graphical representation of the vehicle navigating the selected terrain is visualized through an open-source 3D graphics tool.

Although initially designed for a trade study focused on a specific vehicle design, the model boasts the flexibility and capability to accommodate the modeling of future vehicles. Its component and environment interchangeability allows users to modify or

substitute various aspects of the vehicle, including power system components, chassis masses, tyres, transmission, duty cycles, courses, and more. Consequently, users can effectively model vehicles with similar component types or structures and utilize the model to assess their impact on various vehicle design considerations such as mass requirements, volume constraints, power system needs, wheel design, suspension characteristics, and controls. This flexibility has already led to the development of several new vehicle models [31].

Gauchia and Sanz (2010) noted that the current energy landscape remains heavily reliant on fossil fuels, particularly oil. This dependence is becoming increasingly precarious due to diminishing reserves, uncertain oil resources, and the geopolitical and economic implications of a concentrated distribution of fossil fuel reserves in a limited number of regions. The transportation sector is particularly susceptible to this situation and must explore new energy sources and systems to reduce reliance on oil while addressing environmental concerns. As a result, vehicle manufacturers are increasingly turning to hybrid and electric vehicles. Hybrid vehicles integrate an internal combustion engine (ICE) with energy storage systems, allowing for a reduction in the installed power of the ICE, thereby decreasing fuel consumption and pollutant emissions. With this powertrain, users have the option to drive in pure electric mode, utilizing the energy storage system (typically batteries), or in a hybrid mode that combines both the ICE and storage for more demanding driving conditions.

Electric vehicles are particularly intriguing due to their elimination of internal combustion engines (ICEs), resulting in zero emissions on the road and a more efficient powertrain for environmentally-friendly operation. However, despite these compelling reasons, there are several challenges that must be addressed before achieving mass production on a large scale. These include the need for energy technologies that can ensure sufficient vehicle range, attractive power ratings, and safe, convenient, and swift recharging. Currently, there is no electric energy storage technology that can simultaneously provide high energy and power densities, which are essential to meet range and acceleration requirements. Hence, there is an extensive research effort aimed at developing new materials for electrochemical energy devices and hybridizing electrochemical energy systems to meet the necessary power and energy specifications.

The most widely explored technologies are Ni-Mn and Li-based batteries, which offer higher energy densities compared to conventional Pb-acid batteries. However, these technologies have yet to achieve the range capabilities of fossil fuels. Therefore, alternative energy systems like fuel cells or flow batteries are under investigation as part of a hybrid electric vehicle power train. Lastly, research on these energy systems must account for the unique demands of transportation, where the weight, volume, and cost of the integrated systems play a critical role in the successful and widespread adoption of electric vehicles. To conduct this research at the final application stage of

electrochemical systems, it is imperative to have the capability to test, model, and simulate these systems under real operating conditions [32].

Creed et al. (2010) elaborate on the development of a comprehensive car model, as depicted in **Fig. 2.8**, designed for a standard road-going vehicle. This model has been outfitted with suspension force actuators in preparation for future advancements in active suspension control systems, aimed at enhancing the vehicle's ride comfort. Such systems are increasingly prevalent in both passenger and commercial vehicles. Their adaptable nature allows for specific tuning tailored to either performance or comfort, rendering them highly versatile for a range of applications. Active suspension focuses on regulating the vehicle's vertical movements in response to the road inputs encountered by each wheel. This is achieved by actively applying vertical forces within the suspension to counteract some of the effects of the road surface. Consequently, these systems can effectively reduce vehicle body roll, mitigate vertical accelerations experienced by passengers, and enhance overall vehicle handling [33].

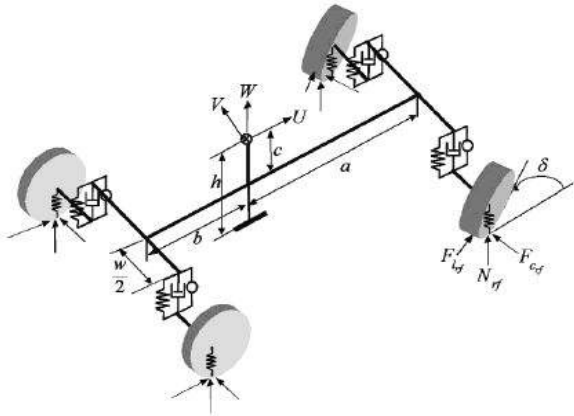

Fig. 2.8 Full car model

Lyons et al. (2011) emphasized that proficiency in mechanical engineering necessitates the capacity to investigate and analyze intricate thermal and mechanical systems. A highly effective method for students to cultivate their comprehension of mechanical engineering systems is through hands-on experience in small groups within a laboratory setting. This paper outlines a proposal to create a distinctive capstone laboratory course that offers such an experience. The course, Engineering System Laboratory (ESL), will revolve around a cohesive series of laboratory experiments conducted on an automobile and its various subsystems. The choice of an automobile as the subject of study is deliberate, as it is compact, reasonably cost-effective, and falls within the direct experience of most students. Furthermore, its diverse and intricate subsystems afford students opportunities to apply a broad spectrum of mechanical engineering knowledge, encompassing principles of mechanics, dynamics, thermodynamics, heat transfer, and controls [34].

Phalke T.P and Mitra A.C. (2016) highlight the ongoing trend in vehicle design, which prioritizes maximizing comfort for both drivers and passengers, even in varying road conditions. The suspension system, a crucial component of a vehicle, plays a significant role in dampening road vibrations and ensuring a comfortable experience for both the driver and passengers. This paper conducts a performance comparison between passive and semi-active suspension systems using a quarter car model. The evaluation is carried out at different vehicle velocities, considering half sine wave bumps, and then extended to various road profiles using MATLAB SIMULINK. The study introduces a semi-active suspension system with a Proportional-Derivative-Integrator (PID) controller, which establishes an optimal and robust system capable of withstanding different road conditions and vehicle speeds to enhance ride comfort [35].

Shihem Dridi et al. (2017) introduce dynamic modeling of automotive suspension using the graphical approach of Bond Graphs. The notable advantage of this active technology lies in its ability to generate the desired force between the unsprung wheel mass and the sprung vehicle body mass, accomplished through a tubular permanent magnet linear synchronous actuator (TPMLSA). The dynamic suspension actuated by the TPMLSA is meticulously modeled employing the Bond Graph formalism. Simulation of this system is conducted within the specialized software environment 20-SIM, designed for Bond Graphs. The findings of this study enable an evaluation of suspension performance in terms of comfort, safety, and the effectiveness of Bond Graph modeling [36].

Yazan M. Al Rawashdeh et al. (2019) addressed the design of a robust full car active suspension system. All parameters, except those pertaining to the car's chassis, are treated as uncertain, with the assumption that the center of gravity position remains fixed. The resulting system contains numerous uncertain parameters, and the robust optimization problem is found to be non-convex. The team employed Particle Swarm Optimization (PSO) to tackle this challenge, resulting in an iterative PSO/LMI optimization algorithm. Sim Mechanics was utilized to construct the nonlinear full car model, allowing for potential extensions to account for complex scenarios, where passengers, goods, or other factors may introduce uncertainties or have their own dynamics on board [37].

Cheng Cheng and Simos A. Evangelou (2019) showcased the enhancement of ride comfort and road holding performance through the novel concept of the active variable geometry suspension (SAVGS) in a new series of road vehicles, utilizing advanced control techniques. Distinguished from previous studies focused on simpler quarter-car models, this research delves into the design and evaluation of control systems based on full-car dynamics, accounting for coupled responses from all four independently actuated corners of the vehicle. The study leverages a nonlinear full-car model that accurately represents the dynamics and geometry of a high-performance car equipped

with the innovative double wishbone active suspension concept. The robust control design capitalizes on the linearized dynamics of the nonlinear model at a trim state, formulated as a disturbance rejection strategy aimed at reducing body vertical accelerations and tyre deflections while ensuring operation within existing physical constraints. The proposed controller is implemented in the nonlinear full-car model, and its performance is scrutinized in both frequency and time domains for various operating maneuvers, compared to conventional passive suspension systems and previously designed SAVGS control schemes employing simpler vehicle models [38].

Diana Dacova et al. (2021) shed light on the impact of vibrations, noise, and acceleration on passengers and drivers in vehicles, all of which have implications for comfort, activity levels, and overall health. The extent of this impact depends on the frequency, amplitude, duration, and direction of the vibrations. Prolonged exposure to vibrations can lead to driver and passenger fatigue, resulting in reduced performance and diminished functional capacity. This, in turn, can compromise traffic safety, underscoring the importance of prioritizing ride comfort in modern vehicle design. Ride comfort encompasses a range of conditions, impacts, and sensations experienced by individuals while traveling in vehicles. Over the years, numerous studies and scientific advancements have focused on measuring, evaluating, and analyzing various factors influencing ride comfort. This paper provides an overview of research studies concerning the dynamic factors affecting ride comfort in road vehicles. It also delves into the methods employed for measurement and evaluation. Finally, the paper presents existing recommendations for enhancing ride comfort in road vehicles [39].

2.5 ANALYSIS AND DESIGN OF VEHICLES CONSIDERING VIBRATIONS AND COST

The bond graph concept, introduced by Paynter H.M. et al. in 1961, revolutionized physical system modeling. This approach supports 0 and 1 junction elements, treating an object as a system of interconnected elements [40].

Karnop D. and Rosenberg et al. (1975) parameterized mathematical systems using the Kirchhoff bond graph approach to electrical networks system.[41].

Mukherjee A. et al. (2000) introduced the Symbols2000 software for modeling, simulation, and design, featuring an Encapsulation Subsystem Model known as a capsule [42].

Loukas S. Louka et al. (2001) presented an integrated model of vehicle subsystems utilizing bond graphs. They employed an energy-based modeling approach to enhance the performance of vehicle systems [43].

Brendan J. Chan et al. (2003) employed Matlab to obtain acceleration-versus-time and displacement-versus-time data to evaluate their design simulation results for ride control systems. They compared the results of the modified MCVD system with the idle system, examining chassis acceleration, chassis displacement, and axle displacement versus time [44].

Kyung-Tak Hong et al. (2003) addressed the improvement of passenger car ride comfort using air cells. They found that the use of air cells, especially for various road turbulences, optimally distributes pressure between the human body and the seat surface. They conducted experimental studies to determine the spring constants and damping coefficients of an air cell with three degrees of freedom in a quarter car model [45].

Shing Jen Wu et al. (2004) describe optimal fuzzy control design for half car active suspension systems.[46].

German Filippini et al. (2005) conducted an evaluation of a nonlinear four-wheel vehicle dynamic bond graph model. Utilizing Modeling and Simulation 20sim software, they incorporated vehicle components like chassis, transmission, and pneumatic tyres into the bond graph model for simulation through 20sim [47].

Adibi Hadi and Rideout Geoff et al. (2006) conducted an investigation on an active suspension system for a full car model with seven degrees of freedom, aiming to reduce bounce, pitching, and rolling effects on random road profiles. Their hybrid bond graph simulation yielded results for buoyancies acceleration, pitch acceleration, and roll acceleration [48].

Mukharjee A. et al. (2006) discussed the use of Bond Graph in Modeling and Simulation and introduced the software Symbol Shakti at IIT Kharagpur [49].

Mahala Manoj K. et al. (2007) introduced mathematical models with lumpy parameters for studying vehicle dynamics. The paper examines various models under diverse road conditions [50].

Shirhatt Anil et al. (2008) have proposed that optimizing the road performance of active suspension is constrained by control bandwidth. They achieved theoretical analyses utilizing the primary function of vehicle suspension through tyres for passenger comfort. Their results showed significant reductions in bounce-back, passenger acceleration, and displacement, with reductions of 74.2%, 82.7%, and 28.5% respectively [51].

Kum-Gil Sung et al. (2008) assessed robust vibration control using an electro-rheological (ER) suspension system in a passenger vehicle. They employed a Fuzzy Moving Sliding Morse Controller (FMSMC) and experimentally demonstrated that ER suspension can enhance the vibration level of sprung mass acceleration while significantly reducing body resonance [52].

Junoh, A.K. et al. (2011) emphasized the importance of a comfortable driving environment in passenger car cabins. They noted that the comfort disturbance is influenced by factors such as magnitude, frequency, direction, and duration of the vibrations [53].

Jie Gao et al. (2011) developed Frequency –domain simulation and analysis of vehicle ride comfort based on virtual proving ground a virtual model to assess vehicle ride comfort.[54].

Rafal Budzik et al. (2012) emphasized that information obtained from vibration signals plays a crucial role in ensuring driving safety and comfort on the road. They considered motor engines as vibration sources in rotating machinery [55].

Seygin A. et al. (2012) investigated the effects of vibration using a simulation program with a complete vehicle model. Road roughness was used as an input to the system, and it was found that driving at a speed of 72 km/h (20 m/s) for 5 to 6 hours on a smooth road could lead to discomfort [56].

Avesh M and Srivastava R. et al. (2012) proposed an active suspension system for automobiles to enhance ride comfort for passengers and improve vehicle stability by reducing vibrations in the suspension system [57].

Guangqiang Wu et al. (2013) addressed the coupling of rigid and rigid-flexible modes in vehicle multibody dynamics. They applied the Finite Element Method (FEM) to model a flexible rear suspension [58].

Mitra A. et al. (2013) validated a full-car model under different road profiles using analytical methods in Matlab/Simulink [59].

J.B. Ashtekar and A.G. Thakur, 2014, describe Simulink Model of suspension system and its validation on suspension system and its validation on suspension tests Rig.[60].

Hasan Galal Ali et al. (2014) simulated the mathematical model of a quarter car, evaluating spring mass, displacement, and acceleration for a comfortable ride at speeds not exceeding 6.75 km/h [61].

Radionova L.V., and Chernyshev A.D. 2015, deals with Mathematical model of the vehicle in MATLAB/ Simulink.[62].

Patil Ashish R. et al. (2015) discussed quarter-car models involving non-linear spring forces, Hyundai properties, and the Electra model suspension spring [63].

Liqiang Jin et al. (2016) conducted a study on a quarter motor vehicle, employing an eleven-degree-of-freedom mathematical model for assessing ride comfort using MATLAB/Simulink [64].

Banerjee Saayan et al. (2016) discussed the mathematical model of a full track with hydro-gas suspension, incorporating a trailing arm system with 17 degrees of freedom [65].

SHARP R.S. and Pilbeam C. , 2016, describe On the ride comfort benefits available from road preview with slow active car suspension, Vehicle system dynamics.[66].

Sihem Dridi et al. (2017) demonstrated the modeling of a dynamic actuator, the tubular permanent magnet linear synchronous actuator (TPMLSA), using Bond graph formalism. This approach aimed to minimize wheel vibration for a more comfortable ride in vehicles [67].

Dahil L. et al.(2017) deals Effect on the vibration of the suspension system for ride comfort.[68].

Varude Vinay R. et al. (2018) examined how the suspension system strikes a balance between ride comfort and road holding. Their paper focused on a two-degree-of-freedom passive suspension system model [69].

Majid Amar et al. (2018) described the modeling, simulation, and control of a Linear Half Car Suspension System using algorithms in Matlab/Simulink. They studied the pitch and heave motion of the sprung mass in an active suspension system with Fuzzy PID control [70].

Hamed M. et al. (2018) designed a seven-degree-of-freedom suspension system for a complete car to ensure a comfortable ride. The suspension's primary function is to shield the driver and passengers from vibrations. They simulated spring stiffness defects at 25%, 50%, and 80%. Additionally, a mathematical model for a light vehicle addressing vibration damping with seven degrees of freedom for a full car was developed using Matlab/Simulink. The results demonstrated that a cost-effective model could be developed for use on inconvenient, uneven, pothole-filled, and damaged rural roads, providing better performance, durability, and cost-effectiveness. This approach

could bolster the country's economy and contribute to energy conservation efforts to reduce carbon emissions [71].

Yeqing Lu et al. (2018) constructed a complete car model with seven degrees of freedom, utilizing a virtual prototype and obtaining simulation results using an ADRC controller for ride comfort [72].

Kumar Vivek et al. (2018) employed Bond graph modeling to derive the vertical dynamics of a passenger car, utilizing an eight-degree-of-freedom full car model. This model accounted for the rolling motion of spring, unsprung mass, pitching, and spring mass [73].

Kumar Vivek et al. (2018) addressed the hunting problem in high-speed rail transport, which can cause discomfort and physical damage to passengers. They employed a 31 Degrees of Freedom railway vehicle model using Bond Graph methodology [74].

Cheng Cheng et al. (2019) detailed enhancements in road ride comfort and road-holding performance achieved through the implementation of the Active Variable Geometry Suspension (SAVGS) concept [75].

Yazan M. Al. Rawshad et al. (2019) focused on studying the chassis of a car with a fixed center of gravity position using a swarm optimization technique. They utilized simulation mechanisms to create a full car active suspension system based on the laws of motion.[76].

Assemkhanuly A. et al.(2019) describe Mathematical and computer model in estimation of dynamic process of vehicles for comfort ride.[77].

Avesh M and Srivastava R. (2020) explained that the comfort index generally remains independent of the seat and occupants, although the human sensitivity factor can be taken into account [78].

2.6 NOTABLE TECHNOLOGICAL ADVANCEMENTS IN ENHANCING RIDE COMFORT

Commercial vehicles play a pivotal role in the transportation of goods and passengers, revolutionizing supply chain management. Over the past few decades, the manufacturing of these vehicles has seen a wide array of technological advancements. These range from the transition from manual to power steering, the shift from diesel engines to electric-powered ones, and the evolution from conventional braking systems to ABS braking technology. These innovations have significantly improved performance, reliability, comfort, and adherence to industry standards.

With the advent of technology, commercial vehicles have even been developed to operate autonomously, without the need for human intervention. However, there remain significant challenges that impede further progress in this field. The future of commercial vehicles looks promising, with the emergence of technologies like electric-powered and autonomous vehicles. This article provides a comprehensive overview of these advanced technologies in commercial vehicles, outlining their respective strengths and weaknesses, applications, current challenges, and prospects for future development in the industry.

In (2006) Shunichi conducted research on the technological advancement of driving support systems based on human behavioral characteristics. They emphasized the growing significance of driving support and cruise assist systems in enhancing both road traffic safety and convenience. The goal is to achieve a high-quality "driver-vehicle symbiosis under all conditions." However, many traffic accidents stem from improper driver behavior. The author's focus lies in understanding driver behavior across different driving scenarios, conducting thorough measurements and analyses of visual perception, attention patterns, and other perceptual aspects involved in driving. This research aims to support the development of driving support systems and technologies that reduce driving workload, functioning as integrated human-vehicle systems that take these behavioral characteristics into consideration [79].

Chen Zhengke in their (2015) research, delved into the study of ride comfort in nonlinear suspension systems of vehicles. They emphasized that the vehicle's suspension system is a crucial element in ensuring ride comfort, often referred to as the essence of chassis design. The performance of the suspension system directly impacts both the ride comfort and handling stability of the vehicle. Therefore, the design of the suspension system must meet the requirements for both ride comfort and handling stability. Additionally, the suspension, which acts as the intermediary component between the frame (or body) and the axle (or wheels), plays a vital role in ensuring driving safety and serves as an important metric for evaluating the overall quality of modern automobiles. The article establishes a model for the vehicle's nonlinear suspension system with two degrees of freedom. It employs a statistical linearization method to convert the issue of random vibration in the nonlinear system into an equivalent problem in a linear system. Furthermore, the research includes simulation studies and real-world testing of actual vehicles. The findings underscore the importance of accounting for the suspension's nonlinearity in the modeling of ride comfort, as this is essential for accurately predicting and researching the vehicle's ride comfort [80].

Adam A. and Sakdirat K. in (2017) conducted a study on improving ride comfort in train journeys by utilizing crowd sourcing through smart phones. They highlighted that

not all train rides are currently assessed for comfort, which is crucial for attracting more passengers to railway services. Enabling passengers to assess ride comfort with their smartphones allows for immediate feedback on the quality of train rides. The study aimed to explore the feasibility of using smartphones to measure vibration-based ride comfort on trains. This involved creating a Smartphone application, analyzing the collected data, and validating it by comparing with data from track inspection vehicles or accelerometers. The research also reviewed commonly used standards for evaluating ride comfort, such as the BS ISO 2631-1:1997 standard and Sperling's ride index. It identified physical causes of discomfort, including vibrations from wheel/rail interface roughness and irregularities.

Notably, the study pioneered the use of artificial neural networks to process Smartphone-derived data for evaluating ride quality. The findings demonstrated the effectiveness of smartphones in assessing ride comfort on trains, suggesting potential avenues for technological advancements. The study concluded that modern smart phone accelerometers are of sufficient quality for evaluating ride comfort, with predictions aligning well with both BS ISO 2631-1 and Sperling's index [81].

In (2021) Paliwal V., Dobriyal R., and Kumar P. conducted a study focused on enhancing ride comfort through the optimization of parameters in a quarter car model equipped with a power law damper. They highlighted the critical role of suspension systems in improving passenger comfort, directly influencing vehicle performance. The effectiveness of a suspension system is heavily contingent on the selection of key parameters like spring stiffness and damping coefficient. In this research, the authors utilized a genetic algorithm technique to optimize the parameters of a passive suspension system incorporating a power law damper for traversing bumps, all while prioritizing passenger comfort. The findings indicated that the most favorable combination of suspension parameters involved higher damping, lower spring stiffness, and a lower power law index. Moreover, it was observed that increasing the values of the damping power index led to a decrease in suspension performance [82].

Ferhath, A.A. and Kamalakkannan, K., in their 2023 review, examined a range of control strategies and algorithms employed in vehicle suspension systems. They emphasized that these systems play a crucial role in ensuring passenger safety, ride comfort, and effective vehicle handling across both passenger and commercial vehicles. Over the past few decades, extensive research coupled with recent technological advancements has led to substantial enhancements in vehicle handling and ride comfort, achieved through the implementation of diverse control strategies in semi-active and fully active suspension systems. Despite the abundance of literature focusing on the enhancement of vehicle suspension systems, there remains a notable gap in understanding the various control strategies and algorithmic techniques employed in this domain. In response to this, the review aims to comprehensively survey the existing research on the diverse control strategies utilized in vehicle suspension systems [83].

2.7 CURRENT INDUSTRY STANDARDS AND BEST PRACTICES OF COMFORT RIDE OF VEHICLES

Best practices refer to established methods and techniques that yield optimal outcomes, enhance productivity, and establish organized procedures. They are widely employed across various industries and professions to streamline operations and uphold industry standards. Familiarizing yourself with best practices can significantly enhance your performance in the workplace. Essentially, a best practice represents the most efficient and effective approach to a given situation. It encompasses a set of tasks and procedures that have been proven to lead to optimal efficiency and results. These practices can serve as industry benchmarks, allowing successful organizations to share their strategies with others in the same field.

In 2002, Manuel Carlos Gameiro da Silva conducted a study focused on measuring comfort in vehicles. He highlighted several factors contributing to the growing interest in evaluating passenger comfort. With increased mobility, people are spending more time in vehicles, leading to heightened expectations for improved ride comfort. Additionally, car manufacturers face challenges in differentiating models based on performance or aesthetics in the same market segment. The assessment of comfort in a given environment is subjective, as different individuals may have varying responses to the same situation. However, opinions on comfort are based on physical variables such as temperature, air velocity, acceleration, and light intensity. Therefore, the initial step in any assessment involves identifying stimuli that can be perceived by human senses and potentially lead to discomfort. For passengers in vehicles, key considerations include temperature, air quality, noise, vibration, light, and ergonomics. Various methods for measuring and evaluating comfort in occupied spaces have been developed, addressing one or more of the mentioned stressors. Alongside discrete measurements of relevant physical parameters, comfort indices that account for human sensitivity and weigh the influences of different variables have also been established for each type of stimulus. Subjective assessments from evaluation panels are widely utilized. Recognizing the importance of interaction between passengers and their environment, researchers have developed various measuring mannequins capable of simulating certain human functions like thermal regulation or breathing [84].

In (2005) Schalk Els conducted a study examining the relevance of ride comfort standards for off-road vehicles. The research aimed to establish a connection between objective techniques for assessing ride comfort and subjective feedback from crew members driving these vehicles. The study utilized various objective measurement methods including ISO 2631, BS 6841, Average Absorbed Power, and VDI 2057, with a specific focus on military vehicles navigating off-road conditions over typical terrains. An experiment was designed and implemented to gather both objective and subjective ride comfort data. The research also analyzed the correlation between different methods,

measurement positions, measurement directions, and calculation approaches. The findings indicated that all the methods can effectively define and assess ride comfort, but the acceptable limits for ride comfort varied. Additionally, the vertical measurement direction emerged as the most influential factor. Given the frequency content of the measured acceleration, the specific weighing curve was found to be less significant for the type of vehicle under consideration [85].

In (2011) Aihua Tang and colleagues conducted an analysis regarding the suitability of ride comfort standards for vehicles. They pointed out the existing shortage of ride comfort standards that apply to various vehicles and terrains. The study introduced evaluation systems for wheeled vehicles, categorized into two groups. One system, which includes ISO 2631 and similar standards, is commonly used for assessing regular vehicles. The other, based on parameters like 6 W average absorbed power and vertical acceleration peak, is employed by the United States and NATO to evaluate the NATO Reference Mobility Model (NRMM). The research included a passenger car test conducted in accordance with national criteria (GB/T 4970 - 1996), resulting in an objective ride comfort value. The study aimed to enhance the understanding and application of ride comfort standards across different types of vehicles and terrains [86].

2.8 NOISE REDUCTION AND VIBRATION DAMPING SOLUTIONS

The pursuit of fuel efficiency and reduced emissions in the automotive industry has led to a focus on lightweight vehicle design. While achieving lower weight is beneficial for overall efficiency, it introduces challenges related to increased noise and vibrations. This section explores the innovative solutions developed in the European FP7 project Green City Car, specifically addressing noise and vibration issues in highly fuel-efficient vehicles with lightweight structures. The project employs a combination of passive and active solutions, including shunted piezoelectric patches, electromagnetic actuation, smart Helmholtz resonators, and advanced active noise control systems.

2.8.1 Challenges in Lightweight Vehicle Design

Efforts to reduce vehicle weight have been successful in optimizing fuel efficiency without compromising performance. However, the weight reduction often leads to increased noise and vibrations due to changes in the vehicle's structure. This poses a challenge for manufacturers to strike a balance between weight reduction and maintaining acceptable noise and vibration levels [87].

2.8.2 Innovative Solutions in Green City Car Project

2.8.2.1 Shunted Piezoelectric Patches: The Green City Car project adopts shunted piezoelectric patches as one of its solutions for noise and vibration reduction. Piezoelectric materials generate an electric charge in response to mechanical stress, and by strategically placing and shunting these patches on vehicle components, vibrations

can be actively controlled. This technology allows for targeted vibration damping, contributing to a quieter and more comfortable driving experience.

2.8.2.2 Electromagnetic Actuation: Another innovative solution employed in the project is electromagnetic actuation. By utilizing electromagnetic forces, the project aims to actively control and attenuate vibrations in the vehicle structure. This approach provides a dynamic and adaptable means of managing vibrations, enhancing overall ride comfort.

2.8.2.3 Smart Helmholtz Resonators: Smart Helmholtz resonators are integrated into the Green City Car's noise reduction strategy. These resonators are designed to absorb specific frequencies of noise, effectively reducing the overall sound level. Their smart functionality allows for real-time adjustment to changing driving conditions, ensuring continuous noise attenuation.

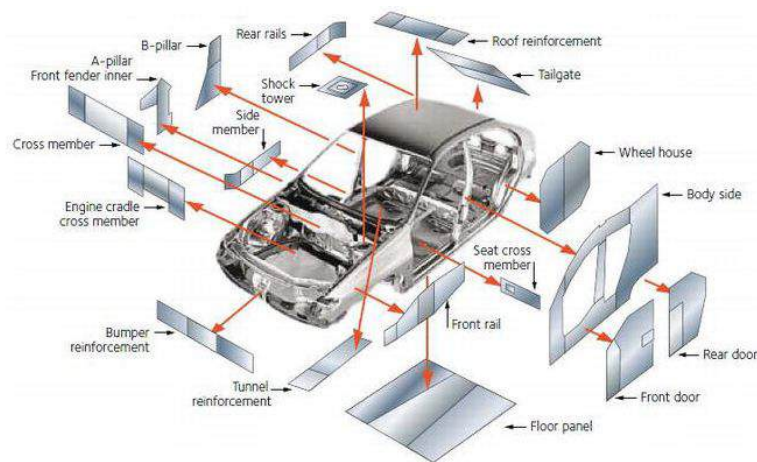

Fig. 2.9: Body-in-white with closures (courtesy: Arcelor Mittal Tailored Blanks)

2.8.3 Active Noise Control Systems and Damping Materials

2.8.3.1 Active Noise Control Systems: The Green City Car project places a significant emphasis on active noise control systems, particularly targeting broadband rolling noise. These systems use advanced algorithms and sensors to detect unwanted noise frequencies and generate anti-noise signals to cancel them out. By specifically addressing rolling noise, which is a substantial contributor to both exterior and interior vehicle noise, the project aims to provide a quieter and more pleasant driving experience.

2.8.3.2 Damping Materials and Acoustic Treatments: In addition to active solutions, the Green City Car project addresses noise and vibration at the source by implementing new damping materials and acoustic treatments. This includes the development and incorporation of materials designed to absorb and dissipate vibrations, reducing their transmission throughout the vehicle structure. Acoustic treatments further contribute to a quieter interior environment.

2.8.3.3 Project Goals and Progress: The Green City Car project sets ambitious goals, aiming for a reduction in noise and vibration levels of approximately 10 dB(A) or more.

This reduction is measured in the final city car product rather than individual components, emphasizing the holistic approach taken by the project. As the project completes its second year, ongoing research and development continue to refine and optimize these noise reduction and vibration damping solutions.

Therefore, the Green City Car project exemplifies the commitment to addressing the challenges posed by lightweight vehicle design. By integrating a range of passive and active solutions, including innovative technologies like shunted piezoelectric patches, electromagnetic actuation, and smart Helmholtz resonators, the project aims to achieve a significant reduction in noise and vibration levels. This comprehensive approach reflects the industry's dedication to not only improving fuel efficiency but also ensuring a comfortable and quiet driving experience for future vehicles.

2.9 INNOVATIVE INTERIOR MATERIALS AND DESIGN

In recent years, the automotive industry has witnessed a transformative shift in the design of vehicle interiors. Consumer expectations have evolved beyond basic functionality to encompass advanced features, enhanced aesthetics, and increased durability. This shift is driven by a desire for a more immersive and comfortable driving experience. Simultaneously, there is a growing emphasis on sustainability, leading to a surge in demand for eco-friendly and environmentally conscious vehicle design. This paradigm shift presents an exciting challenge for manufacturers to not only meet but exceed consumer expectations through innovative interior materials and design.

2.9.1 Consumer Expectations

Modern consumers expect their vehicles to be an extension of their lifestyle, demanding a seamless blend of functionality and aesthetics in the interior design. Features such as advanced infotainment systems, connectivity options, ergonomic seating, and high-quality finishes have become standard expectations. The challenge for manufacturers is to balance these expectations while addressing the increasing call for sustainability and environmental responsibility.

2.9.2 Technological Advancements in Interior Materials

2.9.2.1 Advanced Materials for Enhanced Comfort: Innovative interior materials play a pivotal role in elevating the comfort and aesthetics of vehicle interiors. The use of high-quality, soft-touch materials for surfaces, including dashboards, door panels, and seats, enhances the overall tactile experience for occupants. Additionally, the integration of noise-absorbing materials contributes to a quieter and more serene driving environment, further enhancing the overall comfort of the vehicle.

2.9.2.2 Smart Fabrics and Surfaces: The advent of smart fabrics and surfaces has opened up new possibilities for automotive interiors. These materials can integrate electronic components seamlessly, enabling functionalities such as touch-sensitive

surfaces, ambient lighting, and even interactive displays. Smart fabrics also offer benefits such as temperature regulation, making them both functional and aesthetically appealing.

2.9.3 Sustainable Materials and Environmental Considerations

2.9.3.1 Sustainable Interior Materials: The push towards sustainability has led to the exploration of eco-friendly and sustainable materials for automotive interiors. Manufacturers are increasingly incorporating recycled materials, such as recycled plastics, fabrics made from recycled fibers, and natural materials like bamboo and cork. These materials not only reduce the environmental impact of vehicle production but also cater to environmentally conscious consumers seeking sustainable options.

2.9.3.2 Bio-Based and Vegan Materials: Innovations in interior materials include the use of bio-based materials derived from renewable sources. These materials, such as bio-based plastics and soy-based foams, contribute to a reduction in the reliance on fossil fuels. Additionally, the automotive industry has witnessed the emergence of vegan interior options, with synthetic leather and plant-based alternatives gaining popularity as ethical and cruelty-free choices.

2.9.3.3 Design for Disassembly and Recycling: Beyond material selection, innovative interior design also incorporates principles of disassembly and recyclability. Designing components for easy disassembly at the end of a vehicle's life cycle facilitates recycling and reduces the environmental impact of disposal. This approach aligns with the broader shift towards a circular economy, where materials are reused and recycled to minimize waste.

It is therefore observed that the evolution of automotive interior design reflects a dynamic interplay between consumer expectations, technological advancements, and environmental consciousness. The integration of advanced materials, smart surfaces, and sustainable options demonstrates the industry's commitment to delivering interiors that not only meet but exceed the evolving expectations of consumers. As manufacturers continue to innovate in response to these challenges, the automotive interior landscape is poised for further exciting transformations, where comfort, aesthetics, and sustainability converge to define the vehicles of the future.

2.10 CLIMATE CONTROL AND AIR QUALITY MANAGEMENT SYSTEMS

The significance of maintaining a healthy indoor environment cannot be overstated, with indoor pollution often posing a more immediate and impactful threat to individuals than outdoor pollution.

In response to this, effective climate control and air quality management systems have become essential components of modern living spaces, including automobiles. As individuals spend a significant portion of their time in vehicles, ensuring optimal indoor

air quality is crucial for overall well-being. This section explores the imperative for indoor climate control and air quality management and introduces an innovative technique that leverages technology, specifically an Arduino microcontroller integrated with fuzzy logic, to automate and enhance these systems.

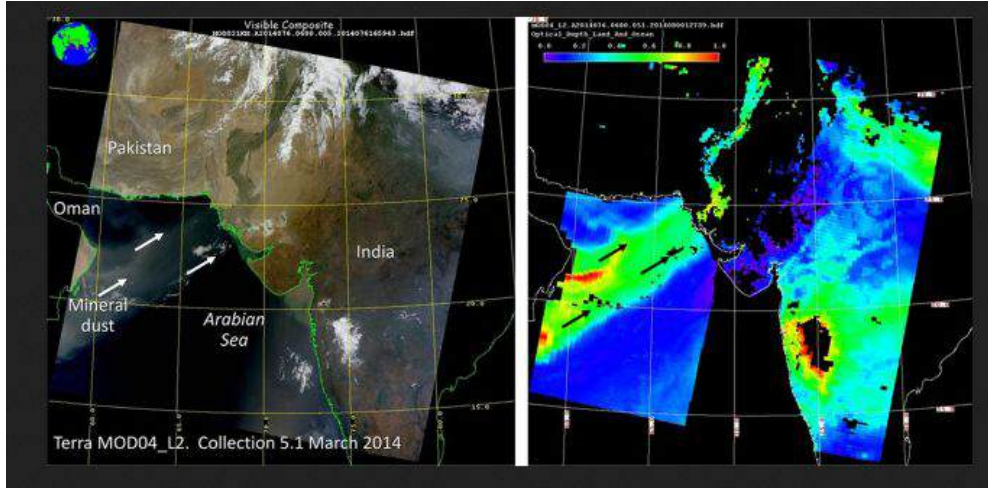

Fig. 2.10: Trans boundary movement of mineral dust over South Asia [88].

Note: Both true color and AOD images are courtesy of Terra MODIS.

2.10.1 Health Impacts of Indoor Pollution

Indoor pollution, arising from factors like inadequate ventilation, emissions from materials, and the accumulation of airborne pollutants, can have profound effects on health. Respiratory issues, allergies, and other health concerns are often linked to poor indoor air quality. Recognizing the impact of indoor environments on health, there is a growing demand for efficient systems that can refresh and maintain optimal conditions within enclosed spaces, such as vehicles.

2.10.2 Introduction to Innovative Climate Control System

2.10.2.1 Integration of Arduino Microcontroller and Fuzzy Logic: The paper introduces a novel technique that combines the capabilities of an Arduino microcontroller with fuzzy logic to automate and manage indoor temperature, humidity, and air quality. This integrated system offers a comprehensive approach to indoor climate control, addressing multiple parameters simultaneously. The use of fuzzy logic allows for a more nuanced and adaptable control system compared to traditional binary control methods.

2.10.2.2 Sensors for Data Collection: Two crucial sensors, the MQ-135 for air quality measurement and the DHT-11 for tracking indoor temperature and humidity, form the data collection backbone of the system. These sensors feed real-time data to the Arduino microcontroller, enabling dynamic adjustments to the ventilation speed. The real-time

monitoring and control capabilities of the system contribute to a responsive and effective indoor climate management solution.

2.10.3 System Performance and Comparison

2.10.3.1 Improved Air Quality, Temperature and Humidity Control: The proposed system showcases significant improvements in air quality, temperature, and humidity control compared to a prior version. The expanded range between minimum and maximum ventilation speed values allows for more precise control over the indoor environment. This adaptability ensures that harmful gases are expelled efficiently, and optimal temperature and humidity levels are maintained, contributing to a healthier and more comfortable indoor space.

2.10.3.2 Reduced Power Consumption and Comparison: Notably, the new model demonstrates reduced power consumption compared to the previous version. This reduction is attributed to the incorporation of a membership function in the fuzzy controller for ventilation speed. The adaptive working intervals and variable room ventilation speeds contribute to more efficient energy use, aligning with contemporary concerns about sustainability and energy conservation.

2.10.3.3 Conclusion and Future Implications: The comparison between the new proposed system and the previous version highlights the distinctions and underscores the effectiveness of the innovative model. The integration of technology, data-driven decision-making, and fuzzy logic in climate control systems represents a significant step towards more intelligent and responsive indoor environments. As this approach is refined and adopted, the implications extend beyond vehicles to broader applications in homes, offices, and other enclosed spaces, contributing to healthier and more comfortable living and working conditions. The ongoing evolution of such systems holds promise for continued improvements in indoor climate control and air quality management.

2.11 EXPLORING RESEARCH GAP AND ITS PRACTICAL APPLICATION

The literature review reveals the development of advanced sub-models, known as Capsules, across various engineering and modeling domains to mitigate road-induced vibrations like bumps and unevenness. These Capsules are automatically generated from system equations, effectively minimizing vibration. They possess the capability to resolve differential causalities and algebraic loops through a robust symbolic solution engine. Additionally, they generate high-level C language code and allow for the integration of external code. Simulations are typically conducted using tools like Bond graph, Simulink / MATLAB, among others.

However, none of the reviewed papers specifically address the distinctions between rural and urban road conditions. It's crucial to acknowledge that the operation of high-speed vehicles on rural roads entails different costs, impacts on vehicle lifespan, and

comfort levels compared to vehicles traveling on highways, expressways, super expressways, district roads, and rural roads. Therefore, there exists ***a notable research gap in the development of vehicles customized for rural and district roads in India.*** Such research endeavors would delve into the economic considerations, vehicle durability, and passenger comfort specific to these road types. This research holds particular significance in India, which boasts the world's second-largest road network, trailing only the United States.

CHAPTER 3

METHODOLOGY

3.1 PROCESS OF VEHICLE RIDE COMFORT

Vehicle ride comfort is a critical aspect of automotive design, directly influencing passenger satisfaction and vehicle performance. Achieving optimal ride comfort involves a systematic process that encompasses vehicle modeling, simulation, testing, and iterative refinement. This process ensures that vehicles can effectively absorb road irregularities, minimize vibrations, and provide a smooth driving experience.

3.1.1 Vehicle Modeling

The process begins with developing detailed vehicle models that represent the dynamic behavior of the vehicle. These models range from simple quarter-car models to complex full-vehicle models, incorporating various components such as the suspension system, tires, and vehicle body. Advanced modeling techniques, like rigid-flexible coupling models, are employed to capture the interactions between rigid and flexible parts of the vehicle, providing a comprehensive understanding of its dynamic responses.

3.1.2 Simulation and Analysis

Once the vehicle model is established, simulations are conducted to analyze how the vehicle responds to different road conditions and driving scenarios. Multibody system dynamics methods are utilized to simulate the vehicle's behavior, allowing engineers to assess ride comfort under various conditions. These simulations help identify potential issues and evaluate the effectiveness of different design parameters in enhancing ride comfort.

3.1.3 Objective and Subjective Evaluation

Evaluating ride comfort involves both objective measurements and subjective assessments:

- **Objective Evaluation:** This involves measuring physical parameters such as accelerations, vibrations, and noise levels within the vehicle. Tools like accelerometers and vibration analyzers are used to collect data, which is then analyzed to determine the vehicle's performance against established comfort criteria. Standards such as ISO 2631 provide guidelines for evaluating human exposure to whole-body vibration, serving as a reference for these assessments.

- **Subjective Evaluation:** Trained test drivers or passengers provide feedback on their perceived comfort during test drives. This feedback is crucial as it reflects real-world experiences and helps identify comfort aspects that may not be captured through objective measurements alone. Subjective assessments often include ratings of ride smoothness, seat comfort, and overall satisfaction.

3.1.4 Optimization and Refinement

Based on the insights gained from simulations and evaluations, engineers proceed to optimize the vehicle's design to enhance ride comfort. This may involve adjusting suspension parameters, modifying seat designs, or implementing advanced control systems. Optimization techniques, such as the Design of Experiments (DOE), are employed to systematically explore the effects of various design variables and identify optimal configurations.

3.1.5 Testing and Validation

The final step involves testing the optimized vehicle under real-world conditions to validate the improvements in ride comfort. This includes road tests over various surfaces and driving scenarios to ensure that the vehicle meets the desired comfort standards. Both objective data and subjective feedback are collected during these tests to confirm that the vehicle delivers a comfortable ride to passengers.

In summary, achieving vehicle ride comfort is a comprehensive process that integrates modeling, simulation, evaluation, optimization, and validation. By systematically addressing each of these stages, automotive engineers can design vehicles that provide a smooth and comfortable experience for passengers, thereby enhancing overall vehicle appeal and customer satisfaction.

3.2 OBJECTIVE OF VEHICLE RIDE COMFORT

Vehicle ride comfort is a critical aspect of automotive engineering that directly influences the passenger experience and overall vehicle performance. The objective of vehicle ride comfort is to minimize discomfort caused by road irregularities, vibrations, and other disturbances while ensuring optimal handling and safety. Achieving this balance requires careful consideration of suspension systems, vehicle dynamics, and human perception.

3.2.1 Enhancing Passenger Experience

The primary goal of vehicle ride comfort is to enhance the passenger experience by reducing physical discomfort and fatigue during travel. Factors such as seat design, cabin insulation, and vibration isolation play pivotal roles. For instance, the suspension system's ability to absorb shocks from uneven road surfaces ensures that passengers are shielded from abrupt jolts. This is especially important in vehicles designed for long-

distance travel or those intended for specific markets where road conditions vary significantly.

3.2.2 Minimizing Vibrations and Noise

A key component of ride comfort is the reduction of vibrations and noise inside the cabin. Vibrations can arise from various sources, including the engine, road surface, and aerodynamic forces. To address this, engineers employ advanced damping materials and innovative suspension designs. Noise, vibration, and harshness (NVH) engineering techniques are utilized to create a quieter and smoother cabin environment, contributing to a more pleasant ride.

3.2.3 Balancing Ride and Handling

While comfort is paramount, it must be balanced with handling performance. A vehicle that is overly focused on comfort might compromise on responsiveness and control, which are essential for safety. Modern automotive systems, such as adaptive suspensions and electronic stability control, enable vehicles to dynamically adjust their ride characteristics to suit varying driving conditions. This ensures that the vehicle maintains its stability and agility without sacrificing comfort.

3.2.4 Addressing Diverse Needs

Vehicle ride comfort must cater to diverse user needs, including different driving environments and passenger demographics. For instance, luxury vehicles prioritize plush interiors and advanced suspension systems, while off-road vehicles focus on robustness and shock absorption. Additionally, factors such as climate, road quality, and cultural preferences influence comfort requirements, necessitating tailored design approaches for specific markets.

3.2.5 Innovations in Ride Comfort

Technological advancements continue to shape the objective of vehicle ride comfort. Active suspension systems, for example, utilize sensors and actuators to adapt to changing road conditions in real time. Similarly, integration of artificial intelligence and machine learning allows vehicles to predict and adjust to road irregularities, enhancing comfort proactively. Autonomous vehicles further emphasize ride comfort as a defining factor, as passengers may engage in activities like reading or working while traveling.

The objective of vehicle ride comfort extends beyond mere convenience, encompassing safety, efficiency, and user satisfaction. By addressing vibrations, noise, and handling dynamics, manufacturers aim to deliver a seamless and enjoyable driving experience. As automotive technology evolves, the pursuit of ride comfort remains a dynamic field, driven by innovation and an ever-deepening understanding of passenger needs and preferences.

3.3 ASSUMPTIONS FOR VEHICLE RIDE COMFORT

The design and evaluation of vehicle ride comfort depend on several assumptions that provide a framework for analysis and testing. These assumptions encompass various aspects of the vehicle, the environment, and human perception. Below, the primary assumptions are elaborated to capture the comprehensive factors influencing ride comfort.

3.3.1 Human Sensitivity to Vibrations

- **Frequency Range of Sensitivity:** Human sensitivity to vibrations is typically most pronounced between 4 Hz and 8 Hz, where resonance effects occur in the human body.
- **Perception of Vertical and Horizontal Movements:** It is assumed that passengers are more sensitive to vertical vibrations compared to horizontal or longitudinal vibrations.
- **Individual Variability:** While the average human sensitivity is considered, individual differences in comfort perception are assumed to follow normal distribution.

3.3.2 Vehicle Dynamics

- **Suspension System Characteristics:** The suspension system is assumed to effectively isolate the cabin from road-induced vibrations. It is modeled as a combination of springs and dampers with predictable behavior.
- **Tire Compliance:** Tires are assumed to provide a degree of damping and isolation, reducing the transmission of high-frequency vibrations to the cabin.
- **Rigid Body Dynamics:** The vehicle body is treated as a rigid structure for simplification, neglecting minor flexibilities.

3.3.3 Road Surface Conditions

- **Standard Road Profiles:** Ride comfort is evaluated under predefined road conditions, such as smooth asphalt, uneven pavement, and gravel roads.
- **Random Roughness Representation:** Road irregularities are assumed to follow a stochastic model with specific power spectral density characteristics.
- **Environmental Influences:** External factors like wind or temperature variations are considered negligible for standard comfort assessments.

3.3.4 Vehicle Speed and Driving Style

- **Constant Speed Assumption:** Evaluations often assume steady-state conditions at specific speeds to isolate the effect of road-induced vibrations.
- **Driving Maneuvers:** The analysis may neglect aggressive maneuvers such as sharp turns or sudden braking, focusing instead on normal driving scenarios.

3.3.5 Passenger Positioning and Load Distribution

- **Seating Posture:** Passengers are assumed to adopt a standard seating posture, with their feet flat on the floor and backs against the seat.
- **Load Symmetry:** The vehicle load is assumed to be evenly distributed to avoid imbalance-induced vibrations.
- **Seat Cushioning Effects:** The seat's cushioning properties are assumed to provide uniform support and damping across passengers.

3.3.6 Acoustic Factors

- **Interior Noise Levels:** Acoustic noise inside the cabin is assumed to be within acceptable ranges and not a significant factor in ride comfort during vibration analysis.
- **Engine and Road Noise:** The primary noise sources are considered constant and predictable under specific operating conditions.

3.3.7 Measurement and Evaluation Standards

- **ISO Guidelines:** Comfort assessments are assumed to follow standards like ISO 2631 for evaluating human exposure to whole-body vibrations.
- **Measurement Tools:** Instruments like accelerometers and vibration analyzers are assumed to have negligible errors.
- **Subjective Evaluation:** Passenger feedback is assumed to be consistent with objective measurements, providing a reliable complement to mechanical data.

3.3.8 Environmental Conditions

- **Ambient Weather:** Standard evaluations assume mild weather conditions without extreme heat, cold, or precipitation.
- **Traffic Conditions:** The influence of external traffic-induced vibrations or shocks is considered minimal.

These assumptions provide a structured basis for designing and evaluating vehicle ride comfort. While real-world conditions may deviate from these idealized scenarios, the assumptions help isolate key variables and enable repeatable, controlled assessments. Future studies may refine these assumptions to account for new materials, advanced suspension technologies, and evolving standards of passenger comfort.

3.4 SYMBOLS SHAKTI SOFTWARE TOOL FOR MODELING AND SIMULATION

This passage provides an insightful overview of the software Symbol Shakti, emphasizing its capabilities and applications in modeling, simulation, and control analysis. Here's a summary of its key features:

3.4.1 Modeling Capabilities:

Users can create models using bond graphs, block diagrams, and equation models. Advanced sub-models, called Capsules, cater to specific engineering and modeling domains.

3.4.2 Symbolic Computation Engine:

Automatically generates fully reduced system equations. Resolves differential causalities and algebraic loops using a powerful symbolic solution engine.

3.4.3 Code Generation and Integration:

Capable of producing high-level C language code. Supports embedding of external code for flexibility in custom solutions.

3.4.4 Simulation Features:

Includes online and post-display simulation. Equipped with event handlers and online event notification. Allows parameter variation during simulations.

3.4.5 Control Analysis Module:

Converts state-space models (from bond graph or block diagram models) into analog or digital transfer functions automatically. Performs various control analyses and supports advanced control applications.

This suite of features makes Symbol Shakti a versatile tool for engineering domains that require precise modeling, simulation, and control. Its object-oriented, hierarchical, hybrid approach enhances its adaptability for different applications.

The description highlights Symbol Shakti as a powerful software tool with several advanced features tailored for symbolic and numeric computation, particularly in research and industrial modeling of large systems. Here's a summary of its key aspects:

- 1) **Contemporary GUI:** Intuitive and user-friendly interface.
- 2) **Symbolic and Numeric Solutions:** Advanced capabilities for both forms of computation.
- 3) **Iconic Modeling:** System-morphic layouts for efficient modeling.
- 4) **Event Handlers:** Enhanced interactivity and functionality.
- 5) **5.Post-Processing:** Comprehensive tools for analyzing simulation results.
- 6) **Integration Requirements:** Requires pre-installed Microsoft Developer Studio (version 5.0 or above).
- 7) **C++ Compilation:** Direct compilation for seamless external code integration.
- 8) **Controls Module:**
Advanced functionalities for state-space, analog, and digital routines.

Includes conversions, filters, and feedback systems.

Handles matrices, transfer functions, quadruples, and numeric data efficiently.

- 9) **Target Applications:** Highly recommended for research and industrial modeling, especially for large systems.

3.5 BOND GRAPH TOOL FOR DYNAMIC SYSTEM

A bond graph is a graphical representation of a physical dynamic system. It is similar to the better known block-diagram and signal-flow-graph, with the major difference that the arcs in bond graphs represent bi-directional exchange of physical energy, while those in block diagrams and signal-flow graphs represent uni-directional flow of information. Also, bond graphs are multi domain and domain neutral. This means a bond graph can incorporate multiple domains seamlessly.

Table 3.1 Efforts and Flow Variables

Systems	Effort (e)	Flow (f)
Mechanical	Force (F)	Velocity (v)
	Torque (τ)	Angular velocity (ω)
Electrical	Voltage (V)	Current (i)
Hydraulic	Pressure (P)	Volume flow rate (dQ/dt)
Thermal	Temperature (T)	Entropy change rate (ds/dt)
	Pressure (P)	Volume change rate (dV/dt)
Chemical	Chemical potential (μ)	Mole flow rate (dN/dt)
	Enthalpy (h)	Mass flow rate (dm/dt)
Magnetic	Magneto-motive force (e_m)	Magnetic flux (ϕ)

The Bond Graph is composed of the "bonds" which link together "single port", "double port" and "multi port" elements (see below for details). Each bond represents the instantaneous flow of energy (dE/dt) or power. The flow in each bond is denoted a pair of variables called 'power variables' whose product is the instantaneous power of the bond. For example, the bond of an electrical system would represent the flow of electrical energy and the power variables would be voltage and current, whose product is power. Each domain's power variables are broken into two types: "effort" and "flow". Effort multiplied by flow produces power, thus the term power variables. Every domain

has a pair of power variables with a corresponding effort and flow variable. Examples of effort include force, torque, voltage, or pressure; while flow examples include velocity, current, and volumetric flow. The table below contains the most common energy domains and the corresponding "effort" and "flow".

A bond has two other features described briefly here, and discussed in more detail below. One is the "half-arrow" sign convention. This defines the assumed direction of positive energy flow. As with electrical circuit diagrams and free-body diagrams, the choice of positive direction is arbitrary, with the caveat that the analyst must be consistent throughout with the chosen definition. The other feature is the "causal stroke". This is a vertical bar placed on only one end of the bond. It is not arbitrary. As described below, there are rules for assigning the proper causality to a given port, and rules for the precedence among ports. Any port (single, double or multi) attached to the bond shall specify either "effort" or "flow" by its causal stroke, but not both. The port attached to the end of the bond with the "causal stroke" specifies the "flow" of the bond. And the bond imposes "effort" upon that port. Equivalently, the port on the end without the "causal stroke" imposes "effort" to the bond, while the bond imposes "flow" to that port. This is made more clear with the illustrative in Table 3.1

3.6 CONCEPT OF BOND GRAPH ELEMENTS

In the bond graph formalism energy is conserved, power flow paths can be identified, and power flow associated with elements and their connections can be readily determined. Generalized inertia 'I' and capacitance 'C' store energy as a function of the system state variables, which are generalized momentum and displacements. The time derivatives of generalized momentum P and displacement q (Q) are generalized effort 'e' and flow 'f', the product of which is power. Generalized resistors R remove energy from the system, and have a constitutive law relating generalized effort to generalized flow. Sources of effort and flow (SE and SF) represent ports through which the system interacts with its environment. Energy is transported among source, storage and dissipative elements through power-conserving "Junction structure" elements. Such elements include power-continuous generalized transformers and gyrators (TF and GY), which are functions of external variables for example of co-ordinates. Kirchhoff's loop and node laws are modeled by power conserving 1 and 0- junctions, respectively. Elements bounded to a 1-Junction have common flow, and their efforts algebraically sum to zero. Elements bounded to a 0- junction have common effort, and their flows algebraically sum to zero. The power bonds contain a half-arrow that indicates the direction of algebraically positive power flow, and a casual stroke normal to the bond that indicates whether the effort or flow variable is the input or output from the constitutive law of the connected element. Full arrows are reserved for modulating signals, and they represent powerless information flows, such orientation angles for co-ordinate transformation matrices. **Table 3.1** defines the symbols and constitutive laws

for energy storage and dissipative elements (“energetic’ elements), source, and power-conserving elements. The constitutive laws are written in an input –output- form consisted- with the placement of the casual strokes.

3.6.1 Source of Effort (SE)

The source of effort is external to a system in the sense of that the system does not influence its output. The source of effort determines the effort in the bond associated with it.

F (t): SE

F (t, P_m, Q_n): SE

6.2.2 Source of Flow (SF)

The source of determines the flow variables in the bond associated with it. For source, the effort variable is an extra system entity and does not influence the output of this source.

V (t): SF

V (t, P_m, Q_n): SF

The P_m and Q_n in the arguments indicate that the corresponding functions are functions of system state as well.

3.6.3 The Inertia Element (I)

Creation of this element is motivated by the idea of a mass point in mechanics. This element relates effort or its integration (the impulse) to the rate of change of momentum or the velocity. The relations for a simple linear inertial element may be written in the following forms:

$$e(t) = \frac{d(m(t)f)}{dt} \tag{3.1}$$

or;

$$f(t) = \frac{1}{m(t)} \int_{-\infty}^t e(\varepsilon)d\varepsilon \tag{3.2}$$

In these expressions the generalized inertia m (t) is taken as function of time.

$$e(t) = \frac{d(p)}{d(t)} \tag{3.3}$$

$$p(t) = \int_{-\infty}^t e(\varepsilon) d\varepsilon \quad (3.4)$$

3.6.4 The Compliant Element (C)

The compliant elements role model is a Hookian spring or an electrical capacitor, which stored energy depending on their configurations. The basic constitutive relation of a single port compliant element in the bond graph maps is written as

$$e(t) = F(t, \int_{-\infty}^t (\varepsilon) d\varepsilon) \quad (3.5)$$

$$f(t) = \frac{dG(t, e(t))}{dt} \quad (3.6)$$

Where F and G are single value functions of their arguments. G is of course respect to its arguments. In bond graph theory the integration of flow is called generalized displacement or charge of the C element,

$$Q(t) = \int_{-\infty}^t f(\varepsilon) d\varepsilon \quad (3.7)$$

The above relation may thus be written as:

$$e(t) = F(t, Q(t)) \quad (3.8)$$

$$\frac{dQ(t)}{dt} = \frac{dG(t, e(t))}{dt} \quad (3.9)$$

$$Q(t) = G(t, e(t)) \quad (3.10)$$

$$e(t) = k(t) \int_{-\infty}^t f(F) d\varepsilon = k(t, Q(t)) \quad (3.11)$$

or;

$$f(t) = \frac{d(e(t)/k(t))}{dt} \quad (3.12)$$

This is linear Hookian spring this has a constitutive relations. The variations in compliant parameters k and c in these linear models indicate function of the stiffness or capacitance with time.

3.6.5 The Resistive Element (R)

Unlike I and C element which relate essentially the integration of effort or flow variables to flow or effort on a bond, the resistive element involves no integration and directly relates the efforts to flow or vice-versa

$$e = \Phi(f) \quad (3.13)$$

or;

$$f = \Psi(e) \quad (3.14)$$

In their linear forms may be

$$e = Rf \quad (3.15)$$

$$f = \frac{e}{R} \quad (3.16)$$

Where Φ and Ψ are simple valued functions of flow or effort respectively

3.6.6 Transformer (TF)

The bond graphic transformer can represent an ideal electrical transformer, a mass less lever; etc. The transformer does not create, store or destroy energy.

3.7 DEVELOPMENT OF THE BOND GRAPH MODEL

Every model is essentially a product of the human mind, and its incompleteness is a reflection of the boundaries of knowledge, the intended purpose behind its creation, or the limitations of the tools and methods employed. In the context of system bond graphs, each graph can be considered a unique piece of art. Similar to other forms of artistic expression, the skill of creating system bond graphs can be cultivated through a judicious combination of learning processes.

The development of bond graph-based models has been facilitated by adopting the notation and ideas presented by Mukherjee et al in 2006. This framework enables the depiction of system dynamics, where the properties and utilities of junctions play a crucial role. Much like an artist carefully brings out the details and nuances of their subject, the construction of bond graph-based models involves a deliberate process to articulate the characteristics of the system's junctions, shown below:

In Bond Graph there are only two kinds of junctions, the **1** and the **0** junction. They conserve power and are reversible. They simply represent system topology and '1' junction represents a common mass point in a mechanical system, a series connection (with same current flowing in all elements) in a electrical network and a hydraulic

pipeline representing flow continuity, etc. Two such junctions with four bonds are shown in the **Fig. 3.1**.

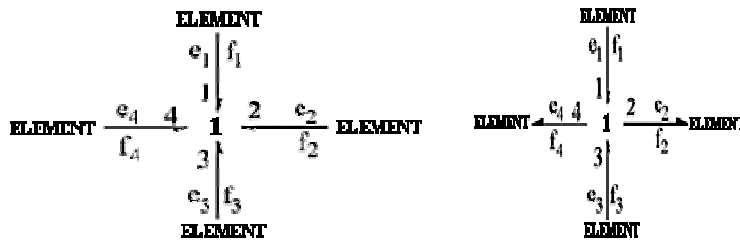

Fig.3.1 '1' Junction Element Models

Using the inward power sign convention, the constitutive relation (for power conservation at the junctions) for the figure above may be written as follows;

$$e_1 f_1 + e_2 f_2 + e_3 f_3 + e_4 f_4 = 0.$$

As **1** junction is a flow equalizing junction,

$$f_1 = f_2 = f_3 = f_4 .$$

This leads to, $e_1 + e_2 + e_3 + e_4 = 0$.

Now considering the other bond graph, the constitutive relation becomes,

$$e_1 f_1 - e_2 f_2 + e_3 f_3 - e_4 f_4 = 0, \text{ and, } f_1 = f_2 = f_3 = f_4.$$

Thus, $e_1 - e_2 + e_3 - e_4 = 0$.

So, a **1** junction is governed by the following rules:

The flows on the bonds attached to a **1**-junction are equal and the algebraic sum of the efforts is zero. The signs in the algebraic sum are determined by the half-arrow directions in a bond graph.

0 - junctions have equality of efforts while the flows sum up to zero, if power orientations are taken positive toward the junction. This junction represents a mechanical, electrical node point and hydraulic pressure distribution point or Pascalian point. Two such junctions with four bonds are shown in the **Fig 3.2**.

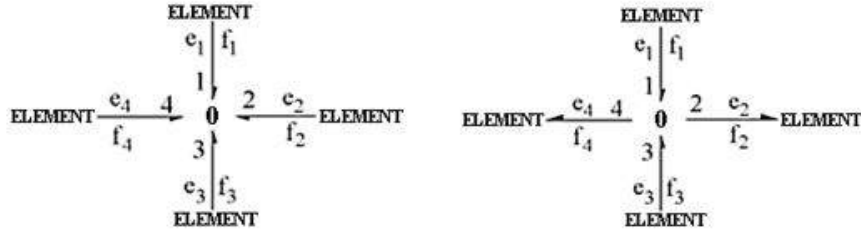

Fig.3.2 '0' Junction Element Models

In case of the model in the left, the constitutive relation becomes,

$$e_1 f_1 + e_2 f_2 + e_3 f_3 + e_4 f_4 = 0.$$

Whereas, the model in the right is governed by the following relation,

$$e_1 f_1 - e_2 f_2 + e_3 f_3 - e_4 f_4 = 0.$$

As 0 junction is an effort equalizing junction,

$$e_1 = e_2 = e_3 = e_4.$$

This leads to, $f_1 + f_2 + f_3 + f_4 = 0$ and $f_1 - f_2 + f_3 - f_4 = 0$, for the left and the right models, respectively.

3.8 CREATION OF SYSTEM EQUATION

Method of generation of system equations is through an augmented (power directed and causalled) bond graph, using a step by step procedure, The difference between equations derived from bond graphs and otherwise is that there will be a set of N first order differential equations, where N is the number of states. (The total number of lumped elements I and C with integral causality present in a system).

A system or a part of it, changes from one configuration to another because there have been, or there are causes which act on it, and the system or a part of it absorbs a part of these causes. The amounts of absorbed causes may be good measures of the states of the system and the way these absorbed causes are changing with time contains the description of its dynamics. The system variables in which the equations are derived are thus the absorbed causes in storage element with integral causalities. The spring or capacitor element (I or C) receives flow and thus displacement or total charge is the associated with this element as

$$Q = \int_{-\infty}^t f dt \quad (3.17)$$

Q is the general symbol which is used for displacement as well as charge. An inertia or inductance with integral causality receives effort as cause. Thus the system variable associated with this element is a generalized momentum as given by

$$P = \int_{-\infty}^t e dt \quad (3.18)$$

System Variables for Bond graph based analysis is

$$\int_{-\infty}^t (cause) dt \quad (3.19)$$

Where Cause is the information going to storage elements with integral causality.

3.8.1 Method of System Equation Generation

The system equations may be generated by answering the following two equations, what do the elements (all) give to the system expressed in terms of system variables and sources? It is known as expanded method. What does the system give to storage elements with integral causality? It is known as matrix method. All the ID (identity) terms created in this method are dimensionless.

In this method the equation may be written in Matrix form as shown below:

$$\frac{d\{X\}}{dt} = [A][X] + [B]\{U\} \quad (3.20)$$

Where

***{X}** is state vector*

***{U}** is input vector*

***[A]** is system matrix*

***[B]** is input matrix*

In this section the method of generation of system equations is discussed. The differential equations describing the dynamics of the system are written in terms the states of the system. All storage elements (I and C) correspond to stored state variables (P for Momentum and Q for displacement respectively) and equations are written for their time derivatives (i.e. effort and flow).

3.9 SYMBOLS BOND PAD

Bond pad can now generate equations as compared to earlier versions where a separate interface was needed. It can generate Simulation Files with handlers and capability for online variation of parameters. The one can build a sub-model and it can be encapsulated as Capsule allowing it to be incorporated in other models. It derives completely reduced set of state equations and for observed detector variables like power. The new equation derivation module is faster and optimizes instruction sets.

The Bond Pad of Symbolshakti software shown in **Fig. 3.3** can now export energetic and signal based sub-models to Matlab using S-function blocks. Models and sub-models are automatically compiled in MEX file format and all non-linear expressions, function calls and libraries are linked transparently to a single block.

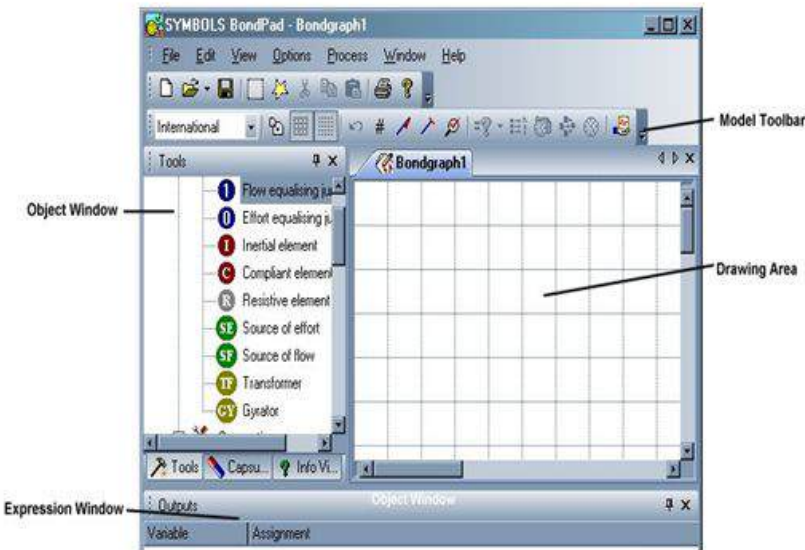

Fig.3.3 Symbols Bond Pad

3.10 SYMBOLS SIMULATOR MODULE

Simulator is the base post-processing module of Symbol Shakti. Here, the usual procedure of simulation using the simulator is presented.

The simulator module shown in **Fig.3.4**, above has a multiple document interface (MDI), which allows multiple simulations of different projects at the same time.

The entry point to simulator is the "module definition File" (.sym file) generated from the Bondpad. One must compile this file using the compile command from the file menu to create a simulator experiment file. After selecting the desired .sym file (Circuit.sym in example), the compilation interface continues as is shown below.



Fig 3.4 Symbols Simulator Module

The user can select to set path for Executable files, Library files and include files from the combo-box. Then using the Add and Remove button, the path list can be updated for each of them. For example, if Borland compiler has been installed in the folder "C:\borland\bcc55" then the executables path must contain "C:\borland\bcc55\bin", they include file path must contain "C:\borland\bcc55\include" and the library files path should contain "C:\borland\bcc55\lib". The save button can save the path information into a initialization file and the user does not need to specify these paths for next time compilation.

3.11 SYMBOLS COMPILATION

Once the compilation commences, the compilation status, errors and warnings, if any, are displayed in a window as shown in **Fig.3.5** and **Fig.3.6**.

The compilation process creates a dynamic link library (DLL) file of the code. This DLL file is loaded by the solver program during simulation of the system. When user presses Close button, the "simulator experiment file" (.sxp file) is created and opened in the IDE. One can open this experiment file any time afterwards to directly continue simulation without taking recourse to the compilation tool unless any changes are made to the base bond graph model and the .sym file. Any changes to the model requires recompilation. Now one can save simulation file by choosing "Generate simulation code" item from the "Process" menu. Next the simulation code is compiled by choosing "Compile" from the process menu. Thus it is necessary to transform these codes to a C++ code and compilation so that it will run with SYMBOLS solver engine to produce numerical results. By choosing "Compile" it will open the compilation window with

active documents simulation code as set path, create, compile and cancel. Now one can Press “Create” button to transform the internal code to a C++ code. Then one can press “Compile” button to compile the newly created C++ codes to a machine language executable code which SYMBOLS SHAKTI simulator module will run along with its solver engine.

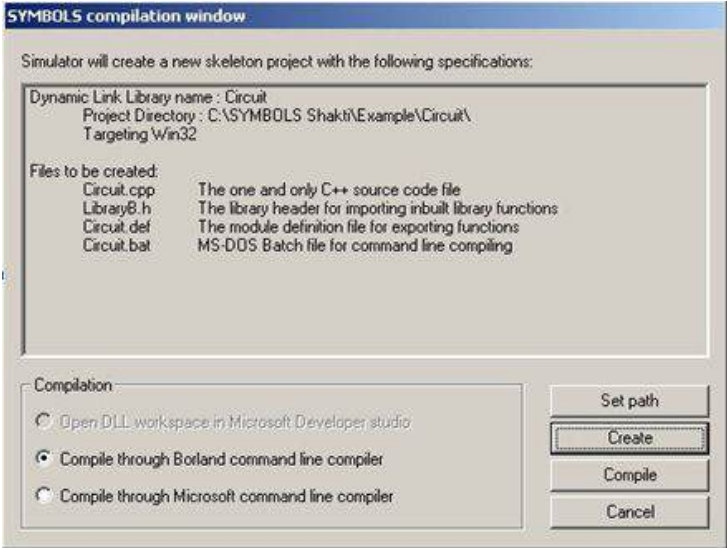

Fig.3.5. Symbols Compilation Window

If any error occurs in compilation, it will show an appropriate error or warning message in “Compile” tab. By double clicking on the error line, one can see where the mistake really occurs. Otherwise, it will show “0 error(s), 0 warning (s)”.

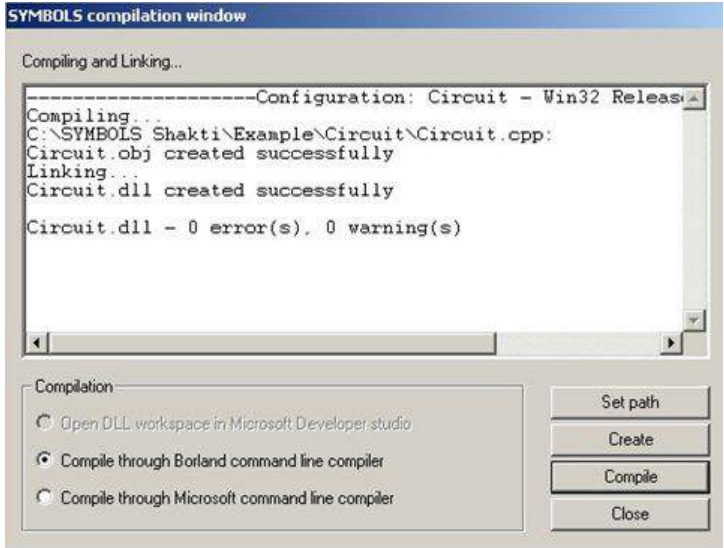

Fig.3.6 Symbols Compilation Window

3.12 SYMBOLS SIMULATOR MODULE CIRCUIT

The experiment window has three panes, which can be adjusted in size through vertical and horizontal splitters. The left part of the window is the system and plotting data setting control. The top-right part is used for online result plotting and the bottom-right part is the simulation specific control window shown in **Fig.3.7**, simulator module-Circuit.ext.

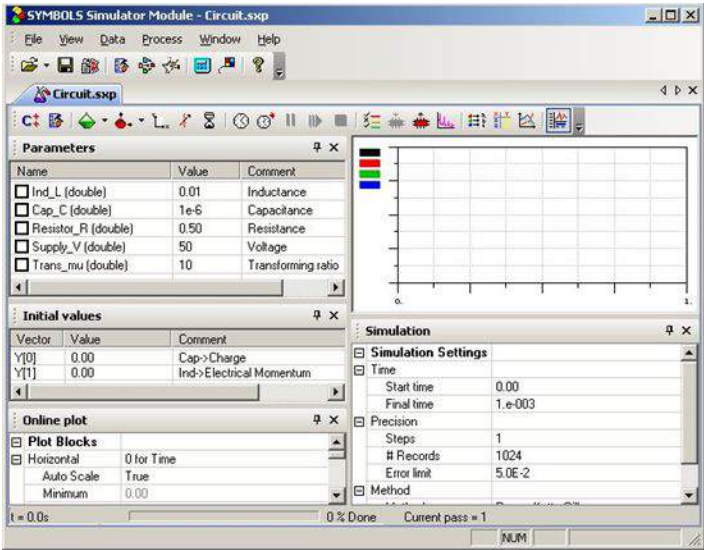

Fig. 3.7 Symbols Simulator Module- Circuit.Ext

Before starting simulation one must enter the appropriate parameter data and initial values, if necessary. When the mouse pointer is placed over a parameter or initial value entry box, the associated comment with that parameter or state is displayed as tool-tip to help the user identify the parameter. In simulator, the states and user states of the system are mapped to two separate 0-indexed arrays, namely Y and User. Information on this mapping can be obtained using the show map command from the view menu.

3.13 SYMBOLS ONLINE PLOT

If online plotting is desired, the plot blocks may be set appropriately. They are situated below the initial value entry space as shown **Fig.3.8**;

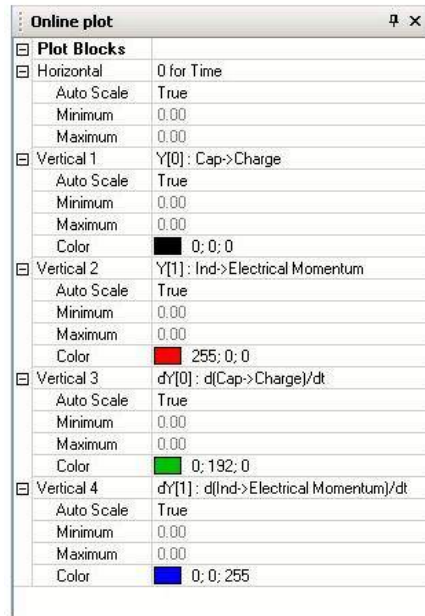

Fig.3.8 Online Plot

One can select up to four plotting variables in the vertical using the combo boxes. The horizontal block may be time or any other state or user variable to obtain either time response plots or phase plots. When the number of states is more, an alternate method of specifying plotting variables can be used by invoking the state map command from view menu. This displays mapping of all the default states of the model, their derivatives and User states. When you double click on any item on the list, a pop-up menu appears as shown below. One can select the appropriate plotting block there.

This window allows one to set the starting and finishing time of the simulation, steps to be taken within recording interval, number of output points or records and the integration error limit.

Graph window by can be opened selecting “graphics display” item from the view menu. Thus a window will appear showing two graphs on it. One can choose “Tile vertically” item from the Mode menu of this window to see two graphs in tile mode as displayed.

CHAPTER 4

MODELING AND ANALYSIS

The preceding chapter underscored the pivotal role of automobile modeling in research, emphasizing the use of diverse software tools. This current work delves deeper into the escalating prominence of novel modeling techniques, particularly those rooted in Bond graph-based approaches. These approaches are gaining traction owing to their manifold advantages, encompassing model flexibility, extensibility, and the automated generation and solution of system equations.

In alignment with the insights of Louca et al. from 2000, an exploration of literature underscores a preference for simplistic models that prove sufficient for various applications. These applications include the swift evaluation of specific features and configurations, as well as the real-time execution of models for control purposes. This preference leans towards simplicity in comparison to more comprehensive models.

Researchers, cognizant of the multifaceted nature of four-wheeled automobile dynamics, have employed diverse methodologies. Their focus spans stability, controllability, environmental considerations, and the intricate realm of autonomous navigation. Building on Kim et al.'s 2003 research, it is evident that the prevailing need is for a model that is both relatively uncomplicated and responsive, especially when real-time application during vehicle operations is a primary consideration.

Recent studies, exemplified by the work of Granda (2008) and Silva et al. (2008), emphasize a nuanced perspective. While comprehensive vehicle models are indispensable for specific applications, simplified models, such as a two-wheeled half car or even a single-wheel quarter model, assume a critical role. These simplified models play a pivotal part in evaluating the active ride control system of vehicles. Additionally, they serve as foundational frameworks for crisis control in the event of vehicular damage.

In light of these insights, the current investigation directs its focus towards the construction of a full car vehicle model. The primary objective is to validate and assess its performance under the challenging conditions posed by uneven roads. The adoption of a Bond graph-based approach is rationalized by its unique capacity to evaluate a spectrum of parameters and, if required, derive real-time iterations of the model. This

approach is deemed suitable for the intricacies of the dynamic interactions involved in vehicular systems.

4.1 DESIGN DEVELOPMENT AND ANALYSIS OF VEHICLE (FULL CAR) BY BOND GRAPH SIMULATION TECHNIQUES FOR COMFORT RIDE

The studies here have been divided into two parts

- a) The first one deal with the modeling of full car with simple spring dashpot suspension on the front end rear wheels as it goes over a road bump; various responses are studies through a bond graph model.
- b) The second study deals with development of a more elaborate suspension model with a hinged arm between the wheels and the chassis with spring and dash pots on both sides of the pivot.

The first model is relatively standard one and has been studied widely with the simplifying assumptions of rigidity of the chassis and linearity of tyre stiffness etc. The bond graph developed for it is to be verified with the one reported in Mukherjee et al (2006) by selecting the parameters reported there. The rocking and heaving motions of the vehicle have to be obtained and then validated with the reported one. The full car model is to be used further to study the performance of the vehicle in terms of other parameters as it passes over the bump. The second model of a hinged arm suspension (often used for active control) is to be developed next. The performance of this suspension is to be modeled as the vehicle goes over a bump on the road.

4.1.1 Full Car Models with a Fixed Suspension

The separation between the center of gravity and the front and back suspensions is denoted as 'b' and 'a' respectively. The vertical movement of the car is represented by spring and dashpot suspensions installed at the front and rear wheels (see Fig. 4.1). To simulate the vehicle's behavior, a velocity step input of 15 m/s was applied, sustained for duration of 10 seconds. The model allows heave and pitching motion of the vehicle to be studied.

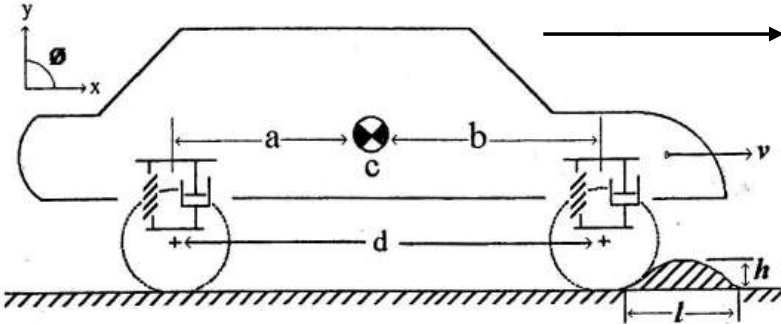

Fig. 4.1 Full car model with a fixed suspension

Description of the Elements of the Bond Graph: The description of the elements of the Bond graphs shown in **Table 4.1**.

Table 4.1 The description of the elements of the Bond graph

Name of the element	Symbol
Flow equalizing junction	1
Effort equalizing junction	0
Inertial element	I
Compliant element	C
Resistive element	R
Source of effort	SE
Source of flow	SF
Transformer	TF

Parameters of a Full Car Model: Parameters of a Full car model with fixed suspension as given in **Table 4.2**,

Table 4.2 Parameters of a full car model with fixed and hinged suspension

Description	Parameter name	Values used
Velocity of the full car	v	15 m/s
Height of ground excitation	h	0.1 m
Length of ground excitation	l	0.3 m
Rear damper	REAR_DM	100 N.s/m
Rear stiffness	REAR_ST	20000 N/m
Front damper	FRONT_DM	100 N.s/m
Front stiffness	FRONT_ST	20000 N/m
Mass of the full car	CAR_MASS	1080 kg
Distance of rear wheel from C.G	a	1.1 m
Distance of front wheel from C.G.	b	0.9 m
Moment of inertia of the full car	J _c _CAR	250 kgm ²

Bond graph based model have been developed using the notation and ideas from the Mukherjee et al (2006). A sinusoidal bump has been selected for the vehicle excitation with the following details, Where h is the height (m), of the ground excitation of the bump, l is the length (m), of ground excitation of the bump, v is velocity (m/s), of full car, d is the diameter (mm), of the wheel and t is time (s).

4.1.2 Road Excitation Model

A road excitation model is a mathematical representation used to characterize the unevenness and irregularities of road surfaces that induce vibrations in vehicles. This model is crucial in vehicle dynamics, as it enables the simulation of road-induced forces and their effects on vehicle components, ride comfort, and durability.

Components of Road Excitation

- **Road Profile:**
The road profile refers to the vertical displacement of the road surface relative to a reference plane. This profile can be measured using specialized equipment and is often modeled as a random process due to its stochastic nature.
- **Excitation Sources:**
 - Longitudinal Irregularities:** Features like potholes, cracks, and expansion joints.
 - Transverse Irregularities:** Uneven lanes or speed bumps.
 - Harmonic Inputs:** Regular patterns such as ripples or corrugations in the pavement.
- **Road Classifications:** Roads are typically classified into categories based on their roughness, such as ISO 8608 road classes. These classifications use a power spectral density (PSD) function to quantify the road surface irregularities.

Mathematical Representation

- **Spatial Frequency Domain:**
The road excitation can be expressed as a function of the spatial frequency, denoted as Ω , which represents the number of surface irregularities per unit distance.

A common model is the **power spectral density (PSD)** of the road surface:

where:

- : PSD of the road profile
- : Spatial frequency (m^{-1})
- : Reference spatial frequency
- : PSD at the reference frequency
- : Roughness exponent (typically 2 for most road surfaces).

$$\phi(\Omega) = \phi(\Omega_0) \left(\frac{\Omega}{\Omega_0} \right)^{-w} \quad (4.1)$$

$$\phi(n) = \phi(n_0) \left(n \frac{n_0}{n_0} \right)^{-w} \quad (4.2)$$

$$\dot{Z} = -2\Pi f_o Z_R + 2\Pi \sqrt{\phi_o} V W_o \quad (4.3)$$

- **Time Domain Representation:**

In the time domain, the road excitation can be approximated as a sum of sinusoidal components with varying amplitudes and frequencies.

- **Simulation Techniques**

- **White Noise Filtering:**

Road profiles are often generated by filtering white noise through a shaping filter to achieve the desired PSD characteristics.

- **Monte Carlo Methods:**

Used to simulate multiple random realizations of road profiles for statistical analysis.

- **Deterministic Methods:**

Specific profiles, such as sinusoidal inputs or step functions, are used for targeted testing.

- **Application in Vehicle Dynamics**

- **Ride Comfort Analysis:**

The road excitation model feeds into vehicle suspension systems to assess comfort levels.

- **Durability Testing:**

Simulates the wear and tear on vehicle components under realistic road conditions.

- **Control System Design:**

Aids in developing active and semi-active suspension systems to counteract road disturbances.

A full car road excitation model is essential for analyzing vehicle dynamics, ride comfort, and road handling performance. The model typically involves a combination of sprung and unsprung masses, suspension components, and road inputs. Below, we outline the derivation of such a model.

Full Car Dynamics

A full car model represents a vehicle's body and its four wheels. The system includes:

- **Sprung mass :** Represents the car body, which is supported by the suspension system.
- **Unsprung masses :** Represent the wheels and axles, for the front-left, front-right, rear-left, and rear-right wheels.
- **Suspension stiffness and damping :** Model the suspension's ability to absorb shocks.
- **Tire stiffness:** Represents the tires' elastic properties.

Equations of Motion

The equations of motion for the system can be derived using Newton's second law.

- For the sprung mass:
- For pitch and roll dynamics:
- For the unsprung masses:

Road Excitation Inputs

The road profile is represented as $z(t)$, which can be modeled as:

- **White noise:** Random irregularities over a range of frequencies.
- **Sine waves:** Periodic inputs for simulating bumps.
- **Power spectral density (PSD):** Realistic representation of road roughness.

Each wheel's vertical displacement due to the road excitation is incorporated into the equations.

4.1.3 Vehicle Modeling:

Vehicle modeling refers to the process of creating mathematical and computational representations of vehicles to simulate their behavior under various conditions. These models are crucial for vehicle design, performance evaluation, and control system development. They provide insights into dynamics, energy efficiency, safety, and environmental impact, among other factors. Below, we explore the key components and types of vehicle modeling.

Vehicle Dynamics

Kinematics and Dynamics: These involve the equations of motion for a vehicle, considering its geometry, velocity, and acceleration. Newtonian mechanics, such as force and torque balance, plays a vital role.

Suspension and Tire Models: Suspension dynamics affect ride quality and handling, while tire models describe the interaction between the tires and the road surface, influencing traction and stability.

Power train Modeling

Internal Combustion Engine (ICE): Models of ICE focus on fuel consumption, emissions, and power output.

Electric Power trains: Electric vehicle (EV) modeling involves battery dynamics, electric motor characteristics, and power electronics.

Hybrid Systems: These combine ICE and electric power trains, requiring models to optimize energy management strategies.

Control Systems

Driver Assistance Systems: Adaptive cruise control, anti-lock braking systems, and lane-keeping assist require accurate vehicle models to predict behavior in real-time.

Autonomous Systems: Autonomous vehicles rely on comprehensive models for path planning, obstacle avoidance, and sensor fusion.

Environmental Factors

Aerodynamics: Modeling airflow around the vehicle is crucial for fuel efficiency and stability.

Road and Weather Conditions: Interaction with varying road surfaces, inclines, and weather scenarios like rain or snow is often included.

Simplified Models

Point-Mass Models: Treat the vehicle as a single point to analyze basic motion, often used in initial stages of design.

Linear Models: Linear approximations are used for small perturbations around an operating point, simplifying analysis and control design.

High-Fidelity Models

Multi body Dynamics: These models capture detailed interactions between various components like chassis, wheels, and suspension systems.

Finite Element Models: Used for structural analysis to ensure safety and durability under stress.

Specialized Models

Energy Models: Evaluate fuel efficiency or battery usage under specific driving cycles.

Crash Dynamics Models: Simulate impact scenarios to design safety features like airbags and crumple zones.

4.1.4 Model Testing Using Bond Graph

Bond graphs are a powerful tool for modeling and analyzing the dynamic behavior of physical systems by representing the flow of energy. They are multidisciplinary, providing insights into mechanical, electrical, hydraulic, thermal, and chemical systems. This document outlines a procedure for using bond graphs to test a system model and validate its behavior against expected results.

System and Testing

The system to be modeled is a simple mass-spring-damper system. The goal of model testing using bond graphs is to:

- Verify the physical plausibility of the system.
- Confirm that the bond graph accurately represents energy storage, dissipation, and transfer.
- Validate dynamic responses against theoretical expectations or experimental data.

Step for Model Test Using Bond Graph

Step 1: Define the Physical System

The mass-spring-damper system consists of:

- A mass that moves linearly.
- A spring (C-element) that stores potential energy.
- A damper (R-element) that dissipates energy.
- An external force (SE-element).

Step 2: Construct the Bond Graph

Construct the bond graph by:

1. Identifying system elements and their interactions.
2. Establishing bonds to represent the flow of power.
3. Labeling effort (e) and flow (f) variables:

Mass: Momentum (p) and velocity (v).

Spring: Force (F) and displacement (x).

Damper: Force (F) and velocity (v).

Bond Graph for Mass-Spring Damper System

- **SE:** Source of effort (applied force).
- **I:** Inertial element (mass).

- **C:** Capacitive element (spring).
- **R:** Resistive element (damper).

Step 3: Derive System Equations

Using the bond graph, derive state equations:

- Constitutive laws:

for the spring.

for the damper.

for the mass.

- Energy conservation:

Combine these to form:

Step 4: Simulate the System

Simulate the system using numerical tools (MATLAB, SYMBOLS SHAKTI).

- **Energy balance:** Ensure input energy equals the sum of stored and dissipated energy.
- **Dynamic response:** Compare position, velocity, and acceleration over time against theoretical solutions or experimental results.

Model Testing

- Mass:
- Spring constant:
- Damping coefficient:
- External force:

Simulation:

Using MATLAB, simulate the system for 10 seconds. Generate plots for:

1. Displacement .
2. Velocity .
3. Energy stored in the spring and dissipated by the damper.

4.1.5 Modeling Road Profiles:

Modeling road profiles is a critical task in the fields of transportation engineering, vehicle dynamics, and infrastructure planning. A road profile represents the elevation changes along a road's surface, capturing its irregularities, undulations, and overall geometric characteristics. Accurate road profile modeling ensures effective vehicle-road interaction analysis, enhanced comfort and safety, and improved infrastructure durability.

The primary objectives include:

Analyzing Vehicle Dynamics: To evaluate the effects of road irregularities on vehicle performance, ride comfort, and safety.

Pavement Design and Maintenance: To assess the wear and tear caused by traffic loads on different road conditions.

Simulations: To provide inputs for virtual testing environments, such as vehicle simulation platforms.

Road profiles are typically classified into:

Macro Profiles: These represent long-wave undulations such as hills and valleys, affecting vehicle stability.

Micro Profiles: These describe short-wave irregularities like potholes and cracks, influencing ride comfort and tire-road interaction.

Road profiles can be mathematically expressed using:

- **Stochastic Models:** These treat road profiles as random processes, characterized by power spectral density (PSD). The ISO 8608 standard categorizes road roughness based on PSD into classes from A (smooth) to H (rough).
- **Deterministic Models:** These use predefined functions or equations to describe specific road features like sinusoidal waves or step functions.

Using sensors like profile meters, laser scanners, or inertial measurement units (IMUs), road profiles are digitally recorded. The sampled data is then processed for analysis and modeling.

FEM techniques create detailed geometric models of road profiles, allowing for stress-strain analysis under various loading conditions.

Road Profile Modeling

International Roughness Index (IRI): Quantifies the smoothness of the road by measuring the cumulative vertical displacement of a standard vehicle.

Root Mean Square (RMS) Elevation: Represents the standard deviation of elevation changes, indicating surface roughness.

Wavelength and Amplitude: These parameters describe the periodicity and magnitude of profile undulations.

Applications of Road Profile Models

- **Vehicle Suspension Design:** Optimizing shock absorbers and suspension systems.
- **Road Maintenance Planning:** Predicting deterioration patterns to schedule timely interventions.
- **Traffic Safety Analysis:** Assessing the impact of roughness on braking distances and vehicle handling.

Challenges in Road Profile Modeling

Data Accuracy: Ensuring high-resolution measurements while minimizing sensor noise.

Environmental Factors: Accounting for seasonal changes like frost heave and thermal expansion.

Computational Complexity: Balancing model fidelity with computational efficiency.

4.1.6 Comfort Measurement of a Full Car

The comfort of a full car is a multifaceted concept that encompasses several parameters including ride quality, noise and vibration levels, seat ergonomics, climate control, and overall passenger experience. Effective measurement of comfort is critical in vehicle design to ensure customer satisfaction and competitive advantage. Below are the key aspects and methodologies used to measure full car comfort.

Ride quality refers to the smoothness of the journey and how well the vehicle absorbs road irregularities. It is primarily influenced by the suspension system, tire characteristics, and chassis design. The key parameters and methods for evaluating ride quality include:

- **Acceleration Measurements:** Sensors placed on the car's chassis and seats record acceleration in all three axes (longitudinal, lateral, and vertical). These measurements help assess how vibrations are transmitted to passengers.

- **Road Profiles:** Ride quality is tested on various road surfaces such as highways, gravel roads, and potholes. Standards such as ISO 2631 are used to quantify ride comfort based on vibration levels.
- **Subjective Evaluation:** Trained evaluators or regular passengers provide feedback on their perception of the ride smoothness. Rating scales (e.g., a 1-10 scale) are commonly employed.

Noise, vibration, and harshness significantly impact the overall comfort of a car. These parameters are evaluated using the following methods:

- **Sound Level Measurements:** Microphones and sound meters are placed at different locations inside the car to measure the interior noise levels during various driving conditions, such as idling, acceleration, and cruising.
- **Vibration Analysis:** Accelerometers record vibrations in the cabin and at specific contact points, such as the steering wheel and floor panels. Advanced tools like Fast Fourier Transform (FFT) are used to analyze vibration frequency and intensity.
- **Psychoacoustic Metrics:** Loudness, sharpness, and fluctuation strength are quantified to assess how noise is perceived by human occupants.

Seats play a pivotal role in passenger comfort, particularly during long journeys.

Pressure Distribution Analysis: Pressure sensors embedded in seats measure the distribution of body weight. Even weight distribution correlates with higher comfort levels.

- **Posture Evaluation:** Cameras and posture analysis software ensure that seat design supports natural spinal alignment and minimizes fatigue.
- **Thermal Comfort:** Sensors monitor the seat's surface temperature and adjust heating or cooling systems accordingly.

The interior climate directly influences passenger comfort. Measurement techniques involve:

- **Temperature Sensors:** Distributed throughout the cabin, these sensors measure temperature uniformity and identify hot or cold spots.
- **Airflow Analysis:** Anemometers measure air velocity and direction from vents to ensure efficient and uniform air distribution.
- **Humidity Control:** Hygrometers assess cabin humidity levels, and automated systems adjust them to maintain an ideal range (typically 40-60%).

The overall perception of comfort is influenced by both physical and psychological factors.

- **Surveys and Interviews:** Real-world passengers are surveyed to provide subjective ratings on factors like seat comfort, cabin space, and ease of entry and exit.
- **Simulations:** Virtual reality tools simulate different driving scenarios, allowing users to evaluate comfort without physical testing.
- **Eye-Tracking and Biometric Sensors:** These tools measure stress levels and attention, providing indirect insights into comfort levels.

4.1.7 Road Excitation Modeling and Comfort Measurement

Road excitation modeling and comfort measurement are critical aspects of vehicle dynamics and passenger comfort analysis. These studies are essential for designing suspension systems, improving ride quality, and reducing fatigue-inducing vibrations.

Road excitation refers to the irregularities and disturbances on a road surface that influence a vehicle's motion. These irregularities can vary depending on road type, condition, and usage. To model road excitations, various methods and mathematical approaches are employed, which include:

1. **Deterministic Modeling:** Deterministic models represent road profiles using predefined mathematical functions. For example, sinusoidal functions can simulate speed bumps, while polynomial curves might approximate undulating surfaces.
2. **Stochastic Modeling:** Road profiles are often better represented as stochastic processes due to their random nature. Power Spectral Density (PSD) functions are widely used to describe road roughness over frequency bands, adhering to international standards like ISO 8608. PSD-based models account for statistical road irregularities and their impact on vehicle dynamics.
3. **Measured Road Profiles:** Real-world data acquisition through laser sensors or profile meters provides accurate road surface representations. These profiles are analyzed and processed to simulate road excitations under laboratory conditions.
4. **Multi Body Dynamics (MBD):** MBD simulations incorporate road profiles into a dynamic system involving the vehicle body, suspension components, and tires. By integrating the road excitations into these systems, the vehicle's response is analyzed under various scenarios.

The response of a vehicle to road excitation is a complex interplay between its suspension system, tires, and body. The primary goal of the suspension system is to isolate the passenger compartment from road-induced vibrations.

- **Natural Frequencies:** Proper tuning of suspension natural frequencies (typically between 1-2 Hz for passenger vehicles) minimizes discomfort.
- **Damping Ratios:** Suspension damping coefficients ensure the system effectively dissipates vibration energy without causing oscillatory behavior.
- **Tire Stiffness:** Tires serve as the first layer of isolation, absorbing high-frequency excitations.

Comfort measurement evaluates the impact of road-induced vibrations on passengers. Several metrics and standards are used to quantify and assess ride comfort:

- **Acceleration-based Metrics:**
 - a) Root Mean Square (RMS) of acceleration is a common parameter that evaluates overall vibration levels.
 - b) Weighted RMS acceleration, as specified by ISO 2631, incorporates frequency weighting to reflect human sensitivity to different vibration frequencies.
- **Ride Index (RI):** The Ride Index measures comfort by combining vibration amplitude and frequency, with lower RI values indicating improved comfort.
- **Subjective Assessments:** Passengers' subjective responses are collected through surveys or controlled experiments. These assessments often complement objective metrics to provide a holistic understanding of comfort.
- **Frequency Response Analysis:** Analysis of frequency response functions (FRFs) helps identify resonance phenomena and their effects on comfort. High-frequency vibrations, typically above 8 Hz, can lead to discomfort or even long-term health issues.

Modern advancements in road excitation modeling and comfort analysis include:

- **Real-time Simulations:** High-fidelity simulators replicate road conditions, enabling virtual testing of suspension designs.
- **Active Suspension Systems:** Adaptive technologies dynamically adjust damping and stiffness in response to road conditions, enhancing ride quality.
- **Machine Learning:** Data-driven approaches predict road profiles and optimize vehicle response for improved comfort.
- **Standards Compliance:** Vehicle manufacturers adhere to ISO standards for consistent evaluation and benchmarking of comfort parameters.

The bump excitation for front wheel is $y = h * \sin\left(\pi * \frac{v}{l} * t\right)$ for $0 \leq t \leq \frac{1}{v}$
 $= 0,$ for $t > \frac{1}{v}$

and for rear wheel is $y = h * \sin\left(\pi * \frac{v}{l} * \left(t - \frac{d}{v}\right)\right)$ for $\frac{d}{v} \leq t \leq \frac{d+l}{v}$
 $= 0,$ for $t > \frac{d+l}{v}$

Creating the Bond Graph Model: A modeling scheme for the full car model as shown in **Fig 4.2**, is visualized, using the literature and the Bond graph logic with two '0' junctions and 4 numbers of '1' junctions with relevant transformers.

Entering into the Bond graph Software, Symbol Shakti is carried out through the entry module called Bond Pad. Entry has been started with the typical flow equalizing '1'

junction structure shown in **Fig 4.2**. The Software assists in various activities which include numbering, causality checks etc. For example the inertial element (I17) is depicted as rotational inertia of the vehicle, compliant element (C18) is the suspension spring of the vehicle.

For the rear portion of the vehicle, resistive element (R1) is the suspension damper and the compliant element is (C2).

Effort equalizing junction (0) shows real suspension of the full car, Source of flow (SF4) shows ground excitation of the car of a real wheel, Transformer (TF6) a mass less lever is connected to the rear wheel of the full car, Flow equalizing junction (1) is given the vertical motion of C.G. of the full car, Inertial element (I7) is mass of the vehicle, compliant element (C9) is heave motion of the full car, velocity of the full car is v .

Similarly for front suspension of the full car the effort equalizing junction (0) shows the front suspension of the car, Source of flow (SF10) shows ground excitation of the car at the front wheel, Transformer (TF12) a mass less lever connected to the front wheel of the full car, Flow equalizing junction for the front wheel is (1), resistive element is (R13) the front suspension damper, compliant element is (C14).

The efforts on the bonds attached to a 0-junction are equal and the algebraic sum of the flows is zero. The signs in the algebraic sum are determined by the half-arrow directions in a bond graph

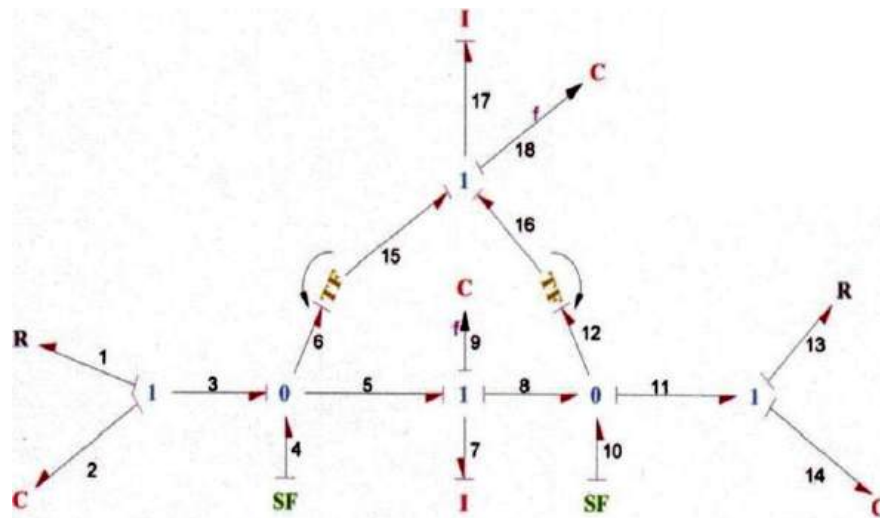

Fig. 4.2 Bond graph model of full car model with a fixed suspension

Running the Model on Symbol Shakti: To run the model is started simulator by pressing simulate item from the process menu. Symbol Shakti simulator window opens with active document. “Parameters” item is chosen from the view menu, A box appears

showing all system parameters followed by a small square box to the left of each parameter. Here, model parameter are set, Time range is set by selecting “Simulation properties” item from the “View” menu.

Simulation time in seconds (say, 10) by typing in the final time edit field on Time group box The Plot block axes are set by selecting “Plot blocks” item from the View menu. Horizontal axis is set “0” for time, and two vertical axes Y [3]:Q4 for vertical “1” (in the display) and Y [2]: Q8 for vertical 2 are selected. Q4 is rocking motion of the full car and Q8 is heave motion of the full car etc.

Simulation and the Results Obtained: The Full car model with fixed suspension has been tested with the parameters shown in the **Table 4.2**, along with the road bump.

Fig.4.3, shows the rocking motion of the full car when the full car is driven at 15 m/s speed. These results match almost exactly with the results for this reported in Mukherjee et al (2006).

Fig 4.4 shows the heaving motion of the full car under the same conditions. These results also match the ones reported in Mukherjee et al (2006). These two validate the model and also proper appreciation and the use of the Software Symbol Shakti.

Further studies have been carried out using the Bond graph Model created. Motion of only the front wheel is simulated in terms of rocking and heaving as it passes over the bump in terms of time and shown in **Fig. 4.5**, and **Fig. 4.6**,

Results show that the behavior of the individual wheels may be significantly different when taken alone, as compared to over all model.

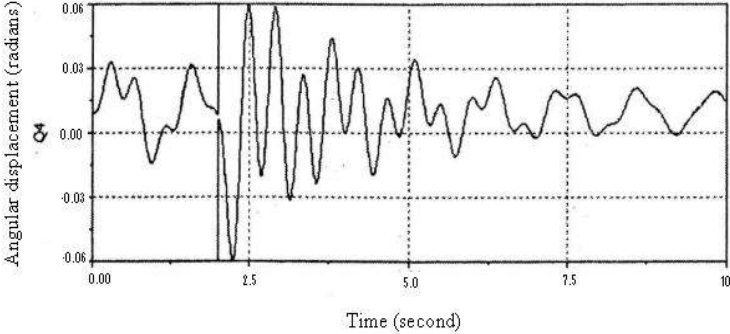

Fig. 4.3: Rocking motion of the full car model at front suspension with vertical angular displacement at C.G., Input parameters to Symbol Shakti, Angular displacement-(Q4 radians), Speed 15 m/s, Time 10 seconds

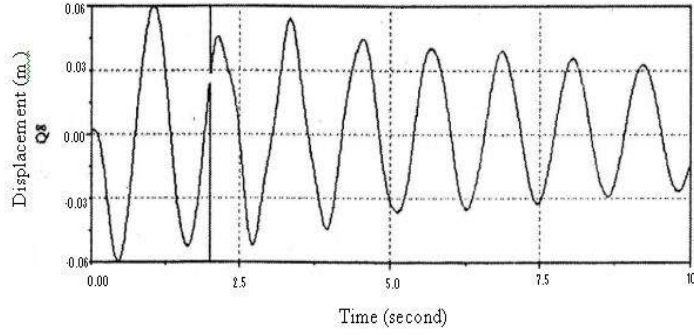

Fig. 4.4: Heaving motion of the full car model at rear suspension with vertical displacement at C.G., Input parameters to Symbol Shakti, Displacement- (Q8 m), Speed 15m/s, Time 10 seconds

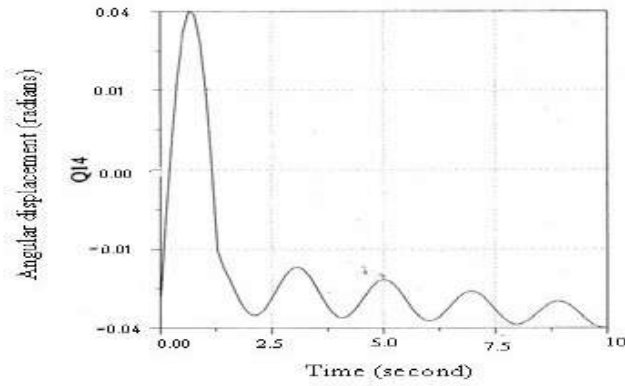

Fig.4.5 Rocking motion of the full car model at front suspension with vertical Angular displacement, Input parameters to Symbol Shakti, Angular displacement- (Q14 radians), Speed 15 m/s, Time 10 seconds

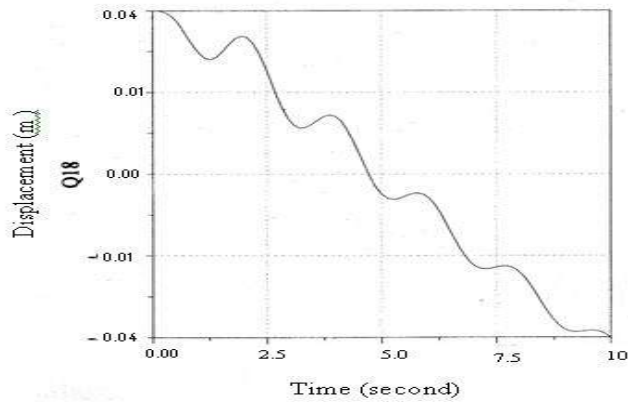

Fig. 4.6 Heaving motion of the full car model at rear suspension with vertical displacement, Input parameters to Symbol Shakti, Displacement (Q18 m), Speed 15 m/s, Time 10 seconds.

Validation of Results and Possibilities of further Studies: Validation of the results obtained was carried out (as explained earlier) with the help of results reported in Mukherjee et al (2006). The first two graphs plotted using the data from Mukherjee et al (2006) dealing with rocking and heaving motion of the full car identical values. This validates proper use of the Software and use of correct units and values. Using the model created has been further used to study the individual behavior of the front and rear suspensions. The behavior of the suspension for going over a bump can be further studied by changing over the parameters in the model developed. It has been further evolved to study hinged arm suspension as shown in the next section.

4.1.8 Modeling Hinged Suspension through Bond Graph Based Full Car Model

As discussed in literature review suspensions for automobiles have been continuously advancing and newer configurations permitting on line control have become practical. These require real time computation and thus simpler but robust models Yazan M. Al Rawashdeh, et al (2019) dealt a robust full car active suspension system is designed. using particle swarm optimization permitting control, where Bond graph models have become well adopted.

Suspensions have evolved with trailing and leading arms, Glass (2001) helping in providing control elements besides affecting the dynamics. Present effort is about a hinged arm suspension as suggested by Mukherjee et al (2006) where basic configuration is of a leading arm (value of lead is a variable). This has to be modeled for a sinusoidal bump (as in the earlier section), and the heave and rocking motion (pitch) have to be studied.

Development of the Vehicle Model: The configuration of the vehicle elements adopted is shown in **Fig 4.7**, which has considerably more elements than the earlier model.

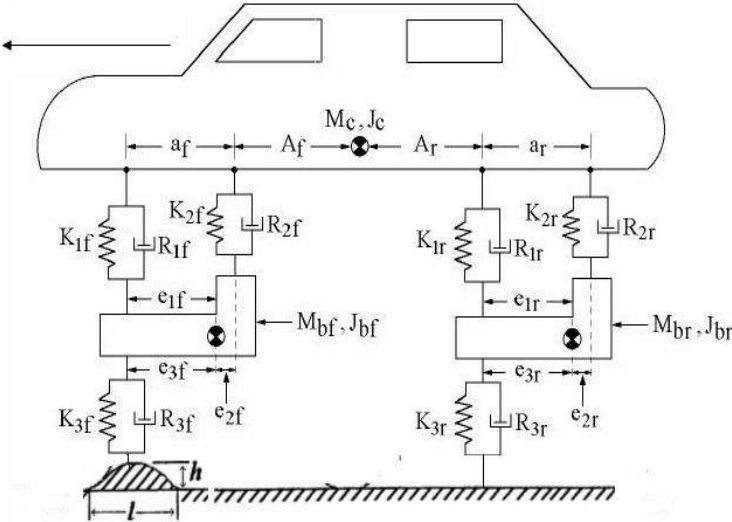

Fig. 4.7: Full car model with hinged suspension

Basically two more hinged platforms have been added which are connected to chassis of the vehicle. Sets of springs and dashpots between the hinged arm and the vehicle are part of the proposition Mukherjee et al (2006). Various elements and their nomenclature is also shown in the **Fig 4.7**, Then three hinged points for the full car also shown.

To simulate the full car, the model was made geometrically symmetric by setting distance $(A_f + a_f)$ for front wheel and $(A_r + a_r)$ for rear wheel effectively placing the models centre of gravity between front and rear wheel of the vehicle. Most of the values for the physical elements of the vehicle have been taken from the vehicle describe in the previous section.

In the proposed model the distance of rear wheel from C.G is 1.1m, the ,Distance of front wheel from C.G is 0.9 m ,Front damper is R_{2f} , Rear stiffness is K_{2r} , Front stiffness is K_{2f} , Rear damper is R_{2r} ,

Mass of the full car is M_c , Rear damper is R_{1r} , Front damper is R_{1f} , Rear stiffness is K_{1r} , Front stiffness is K_{1f} , Moment of Inertia of the full car is J_c , Weight of the hinged arm suspension of the full car is M_{bfg} , Weight of the rear arm suspension of the full car is M_{brg} , Mass of the hinged arm suspension of the full car is M_{bf} , Mass of rear arm suspension of the full car is M_{br} , Moment of Inertia of the rear arm suspension is J_{br} , Moment of Inertia of the hinged arm suspension of the full car is J_{bf} , Front stiffness is K_{3f} , Rear stiffness is K_{3r} ,Front damper is R_{3f} ,Rear damper is R_{3r} Velocity of the car is v .

Development of the Bond Graph Model: The basic effort towards starting a Bond graph model is similar to what has been shown for a non hinged suspension vehicle. The details of the road bump have also been adopted from the previous section. For the proposed configuration two additional hinges along with masses and moment of inertias have been introduced and two sets of additional springs and dashpots between the hinged platform and the body of the vehicle have been introduced. To develop a feasible system transformers have been introduced as shown in the **Fig 4.8**.

As the two halves are symmetrical, only full car model with hinged suspension to be kept in focus. Towards developing the Bond graph description the software itself provides supports for a variety of activities like numbering the Bonds, displaying direction of causality, power and effort flows etc. Infact the software checks the feasibility of the system modeled by displaying zero errors in end if it is logically correct.

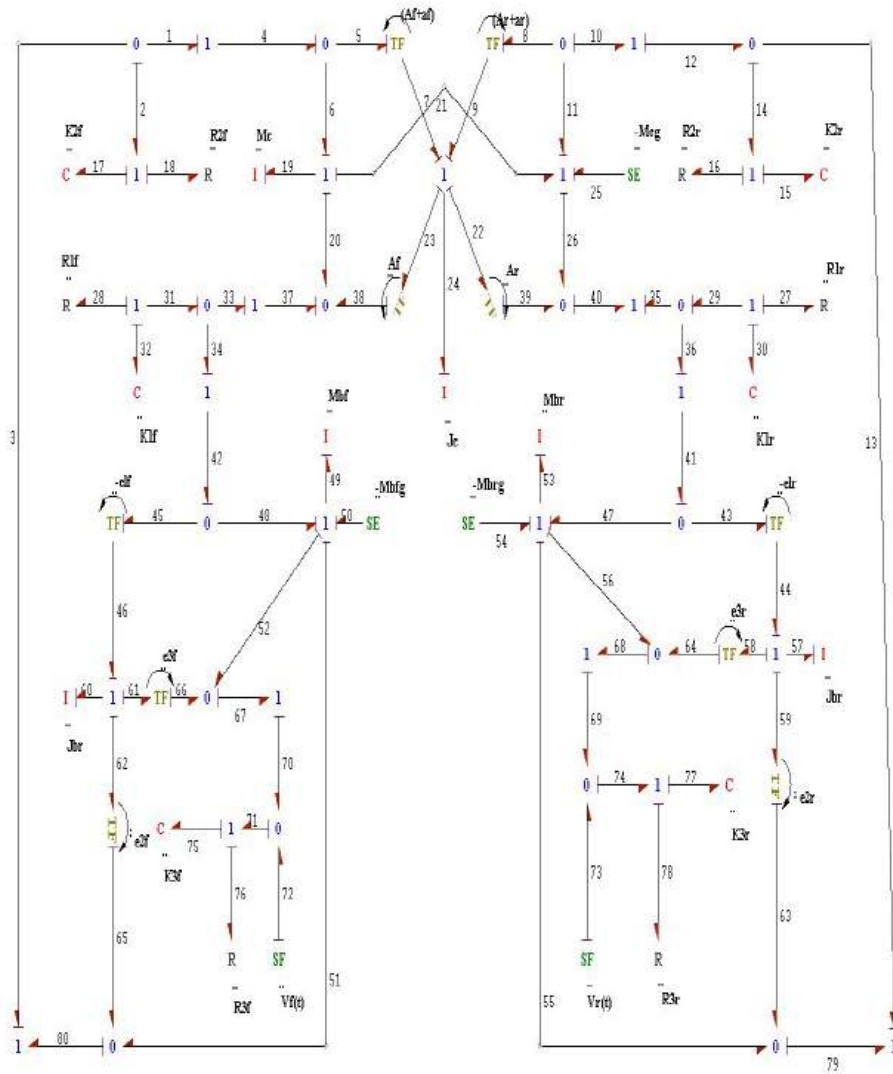

Fig. 4.8: Bond graph model of full car model with a hinged suspension

Despite of this fact, it does not insure that it is Bond graph of the system that was actually to be modeled. To gain further confidence some numerical results have also been obtained as shown in the next section. In the Bond graph M_c is the mass of the car body and J_c is the Moment of inertia as shown in the **Fig 4.7**. Description of bonds and associated elements is as follows.

For the rear suspension compliant element is (C15) rear stiffness is K_{2r} , For the resistive element is (R16) rear damper is R_{2r} , Resistive element is (R27) rear damper is R_{1r} , Compliant element (C30) the stiffness is K_{1r} and also for the resistive element of the rear damper is R_{1r} , Source of effort is (SE54), Mass of the rear arm suspension of the full car (M53) is M_{br} , Moment of Inertia of the rear arm suspension (M57) is J_{br} , For the resistive element (R78) rear stiffness is K_{3r} , Source of flow is (SF73) for the velocity of the full car is v .

For the front suspension resistive element (R18) is for the front damper is R_{2f} , Compliant element (C17) is for front stiffness is K_{2f} , Compliant element (C32) is for front stiffness K_{1f} , Source of effort is (SE54), Mass of the hinged arm suspension (M49) is M_{bf} , Moment of Inertia of the hinged arm suspension (M60) is J_{bf} , Resistive element (R76) front damper is R_{3f} , Source of flow (SF72) for the velocity of the car is v .

Running the Model on Symbol Shakti: A model that has been successfully compiled can also be run on the system and results obtained.

Symbol Shakti also allows the provision of obtaining various plots by specifying the relationships. Activation of the bonds can be done to obtain specific details of the variation of the values. Equation as generated by the system for the full car model with a hinged suspension. These equations have been automatically solved by the Symbol Shakti solver for specific case as shown in **Fig 4.9**,

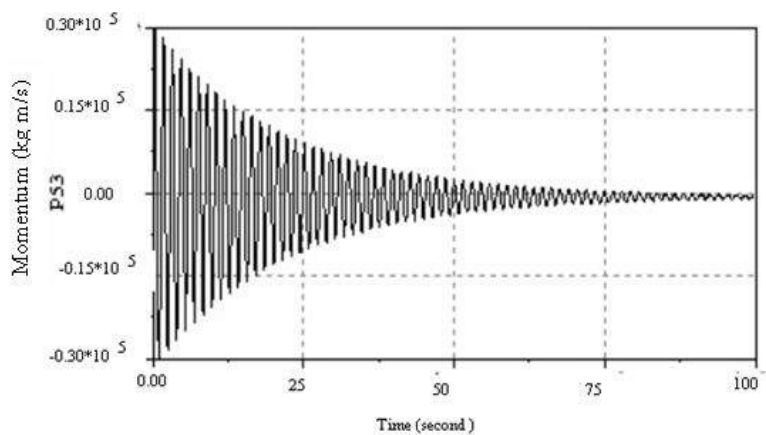

Fig.4.9 Heaving motion of the full car model at rear suspension. Observed through Momentum in bonds, Speed 15 m/s, Time 100 seconds, Numerical data is taken from **Table 4.2**

Results show that if the basic characteristics are not very different then the model may have to be tuned to drift towards any specific desirable objectives.

4.2 OUTCOME

Bond graph-based modeling of various automotive systems has been extensively investigated in literature. This study aims to model a car suspension using a full-car model approach. A hinged arm suspension was selected and modeled for a scenario where the vehicle traverses a bump shaped like a sine wave. Efforts focused on developing the model, as once obtained, various results can be derived.

The study was conducted in two parts. The first part modeled a full car with a simple suspension, and the simulation results were successfully verified with literature data.

The second part extended the first model by incorporating a hinged suspension with a full-car model. A bond graph model was successfully compiled, and preliminary results were obtained for specific scenarios.

CHAPTER 5

RIDE COMFORT AND QUALITY ASSESMENT

5.1 RIDE QUALITY: AN ESSENTIAL ASPECT OF TRANSPORTATION ENGINEERING

Ride quality refers to the level of comfort experienced by passengers or drivers while traveling in a vehicle, whether on roads, railways, or other transportation systems. It encompasses a variety of factors, including vibration, noise, smoothness, and overall stability. Ensuring optimal ride quality is crucial for user satisfaction, safety, and the longevity of transportation infrastructure.

5.1.1 Factors Influencing Ride Quality

Several factors determine the ride quality of a transportation system:

- **Road Surface Conditions:** The quality of the road surface directly impacts ride comfort. Uneven surfaces, potholes, and cracks result in bumps and vibrations that can make a ride uncomfortable.
- **Vehicle Suspension System:** The suspension system of a vehicle is designed to absorb shocks and maintain stability. A well-tuned suspension system enhances ride quality by reducing vibrations and jolts.
- **Tire Characteristics:** The type, pressure, and condition of tires play a significant role in cushioning impacts from road irregularities.
- **Speed:** Higher speeds can amplify the effects of imperfections on the road or track, reducing ride quality.
- **Design of Infrastructure:** Curvature, gradient, and alignment in road or rail design influence the smoothness of a ride. Poorly designed infrastructure can lead to excessive vibrations or lateral forces.
- **External Factors:** Weather conditions, such as rain or snow, can affect ride quality by reducing traction and creating a slippery surface.

5.1.2 Measuring Ride Quality

To ensure high ride quality, engineers use various methods and metrics:

- **International Roughness Index (IRI):** This is a standard measurement used to evaluate road smoothness. A lower IRI indicates better ride quality.
- **Ride Comfort Index:** This index assesses passenger comfort based on vibration levels within a vehicle.

- **Accelerometers:** Devices installed in vehicles or on infrastructure measure vibrations and accelerations to evaluate the level of comfort.
- **Subjective Surveys:** Passenger feedback is also collected to gauge perceived ride quality.

5.1.3 Enhancing Ride Quality

Improving ride quality involves a combination of engineering solutions, maintenance practices, and innovative designs:

- **Road and Track Maintenance:** Regular inspection and timely repairs of roads and tracks prevent the degradation of ride quality.
- **Advanced Materials:** Using high-quality asphalt, concrete, or rail materials can enhance durability and smoothness.
- **Smart Suspension Systems:** Modern vehicles employ active or adaptive suspension systems that adjust dynamically to road conditions, improving comfort.
- **Aerodynamics and Noise Reduction:** Designing vehicles with better aerodynamics and noise insulation reduces external disturbances, contributing to a smoother experience.
- **Technology Integration:** Implementing technologies like sensors and real-time monitoring systems helps detect and address issues affecting ride quality promptly.

5.1.4 Benefits of High Ride Quality

Ensuring superior ride quality has numerous advantages:

- **Passenger Comfort:** Enhanced comfort leads to higher user satisfaction and can influence public preference for certain transportation modes.
- **Safety:** A smooth ride reduces the risk of accidents caused by instability or sudden vehicle reactions.
- **Economic Efficiency:** Better ride quality reduces wear and tear on vehicles, lowering maintenance costs for operators and users.
- **Environmental Impact:** Vehicles traveling on smooth surfaces consume less fuel, leading to reduced emissions and better environmental outcomes.
- **Challenges in Maintaining Ride Quality**
- Despite advancements, maintaining optimal ride quality poses challenges:
- **Budget Constraints:** Limited funding often hinders timely infrastructure maintenance.
- **Aging Infrastructure:** Older roads and tracks require extensive upgrades to meet modern ride quality standards.
- **Climate Change:** Extreme weather conditions, such as heat waves or flooding, accelerate infrastructure degradation.

5.2 RIDE COMFORT:

Ride comfort is a crucial attribute in the design and performance of vehicles, directly impacting passenger satisfaction, safety, and overall usability. It encompasses the physical and psychological experience of passengers as they travel, influenced by factors such as vibration, noise, and the ability of the vehicle to absorb road irregularities. Manufacturers continuously strive to enhance ride comfort, balancing it with other performance metrics like handling, efficiency, and cost.

5.2.1 Factors Affecting Ride Comfort

- **Suspension System:** The suspension system is the backbone of ride comfort. It consists of components such as springs, dampers, and anti-roll bars that work together to absorb shocks and maintain vehicle stability. A well-designed suspension system can significantly reduce the impact of road irregularities on passengers.
- **Spring Stiffness:** Soft springs provide a smoother ride but may compromise handling, while stiffer springs improve handling but can result in a harsher ride. Manufacturers often seek a balance to satisfy diverse consumer needs.
- **Damping Characteristics:** Dampers control the oscillations of the suspension system. Proper damping minimizes vibrations and enhances comfort, especially on uneven terrain.
- **Chassis Design:** A vehicle's chassis plays a pivotal role in determining ride comfort. Lightweight yet rigid chassis designs can help absorb vibrations and improve noise isolation while maintaining structural integrity. Advanced materials like high-strength steel and composites are increasingly used to optimize this balance.
- **Tires and Wheels:** Tires are the first point of contact with the road and directly influence ride quality. Their size, material, tread pattern, and air pressure affect how well they absorb shocks and vibrations. Larger wheels with low-profile tires often prioritize aesthetics and performance but may compromise comfort due to reduced cushioning.
- **Vehicle Dynamics and Aerodynamics:** Vehicle dynamics, including weight distribution and center of gravity, influence how a car handles road disturbances. Aerodynamics also play a role; a well-designed aerodynamic profile reduces wind noise and enhances stability, contributing to overall comfort.

5.2.2 Measuring Ride Comfort

Ride comfort is evaluated using both objective and subjective methods. Objective measurements involve tools like accelerometers to quantify vibration levels, while subjective assessments rely on passenger feedback. Standards such as ISO 2631 provide guidelines for measuring human exposure to vibration, ensuring consistent evaluation across vehicles.

5.2.3 Technological Advancements in Ride Comfort

Recent innovations have significantly enhanced ride comfort:

- **Active and Adaptive Suspension Systems:** These systems use sensors and actuators to adjust suspension settings in real-time, optimizing comfort and performance. For example, magnetorheological dampers alter their viscosity based on road conditions, offering a smoother ride.
- **Noise, Vibration, and Harshness (NVH) Control:** Advanced materials and engineering techniques reduce NVH levels, ensuring a quieter cabin environment. Acoustic insulation, laminated glass, and active noise cancellation systems are common solutions.
- **Smart Tires:** Equipped with sensors, smart tires monitor road conditions and adapt their characteristics to enhance comfort and safety.

5.3 VEHICLE STABILITY

Vehicle stability is a crucial aspect of automotive engineering, focusing on ensuring that a vehicle maintains its intended path and remains controllable under various driving conditions. Stability is essential not only for passenger safety but also for optimal vehicle performance. Factors affecting vehicle stability include tire grip, weight distribution, suspension design, and advanced electronic systems such as stability control mechanisms. Understanding these factors is critical for designing vehicles that are both safe and responsive.

5.3.1 Components of Vehicle Stability

- **Tire Grip and Traction:** Tires are the primary interface between a vehicle and the road surface. The level of grip or traction provided by the tires significantly affects stability. Factors influencing tire grip include the type of tire, tread design, road conditions, and weather. Loss of traction, such as in icy or wet conditions, can lead to skidding or loss of control.
- **Weight Distribution:** Proper weight distribution across the vehicle's axles contributes to stability. A vehicle with a balanced weight distribution is less prone to under steer or oversteer. Engineers aim to position the vehicle's center of gravity as low as possible and ideally near the geometric center of the vehicle to enhance stability.
- **Suspension Systems:** The suspension system plays a vital role in maintaining stability by absorbing road shocks and keeping tires in contact with the ground. Advanced suspension designs, such as independent suspension and adaptive dampers, provide better handling and improve stability during cornering and uneven terrain driving.

- **Electronic Stability Control (ESC):** ESC systems have become a standard feature in modern vehicles. These systems use sensors to detect loss of control and automatically apply brakes to individual wheels to restore stability. ESC works in conjunction with anti-lock braking systems (ABS) and traction control systems (TCS) to enhance vehicle control during emergency maneuvers or slippery conditions.

5.3.2 Types of Stability

- **Directional Stability:** This refers to the vehicle's ability to maintain a straight path without deviating due to external forces such as wind or uneven road surfaces. Directional stability is critical at high speeds, where minor disturbances can lead to significant deviations from the intended path.
- **Roll Stability:** Roll stability concerns the vehicle's ability to resist tipping over during sharp turns or abrupt maneuvers. Factors such as track width, tire stiffness, and the height of the center of gravity influence roll stability. Anti-roll bars and electronic roll mitigation systems help improve this aspect.
- **Yaw Stability:** Yaw stability is related to the vehicle's rotation about its vertical axis. Excessive yaw motion, such as during oversteer or understeer conditions, can cause a vehicle to spin out of control. ESC systems actively manage yaw by braking specific wheels to counteract unwanted rotation.

5.3.3 Enhancing Vehicle Stability

- **Aerodynamics:** Aerodynamic designs reduce lift and improve stability, especially at high speeds. Features such as spoilers, diffusers, and air dams help keep the vehicle planted on the road.
- **Advanced Driver Assistance Systems (ADAS):** Technologies such as lane-keeping assist, adaptive cruise control, and automatic emergency braking contribute to vehicle stability by reducing driver error and maintaining control in various scenarios.
- **Material and Structural Design:** Lightweight yet strong materials improve handling and stability by reducing body roll and ensuring the structural integrity of the vehicle. Advanced manufacturing techniques, such as multi-material construction, further enhance these properties.

5.3.4 Challenges in Vehicle Stability

While significant progress has been made in improving vehicle stability, challenges remain. These include addressing stability in autonomous vehicles, adapting to diverse driving environments, and minimizing trade-offs between stability and fuel efficiency. Additionally, with the rise of electric vehicles (EVs), the placement of heavy battery packs has introduced new considerations for weight distribution and center of gravity management.

5.4 MEASURING AND IMPROVING ROAD VEHICLE COMFORT UNDER VARIOUS RUNNING CONDITIONS

Vehicle comfort is a critical factor influencing passenger satisfaction and driving experience. It encompasses various parameters such as ride quality, noise, vibration, thermal comfort, and seating ergonomics. These aspects are affected by a range of running conditions, including speed, road surface quality, and weather conditions. Effective measurement and improvement of vehicle comfort require a systematic approach, leveraging advanced technologies and design methodologies.

5.4.1 Methods for Measuring Vehicle Comfort

- **Ride Quality Assessment:**
 - Acceleration Sensors:* Devices placed on seats, floorboards, and suspension systems capture data on vibrations and jolts experienced during motion.
 - Subjective Evaluation:* Passengers and drivers rate their comfort using standardized scales such as the Likert scale or similar comfort indices.
- **Noise Measurement:**
 - Sound Level Meters:* Used to monitor interior cabin noise levels during various driving conditions.
 - Frequency Analysis:* Spectrograms identify and isolate specific noise sources such as engine, tires, or aerodynamic disturbances.
- **Vibration Analysis:**
 - Frequency Response Function (FRF):* Determines how vibrations from road irregularities propagate through the vehicle structure.
 - Modal Analysis:* Identifies natural frequencies and modes of vibration to minimize resonances.
- **Thermal Comfort:**
 - Temperature and Humidity Sensors:* Evaluate climate control system performance under different weather conditions.
 - Infrared Imaging:* Measures heat distribution within the cabin.
- **Ergonomic Studies:**
 - Pressure Mapping Systems:* Analyze seat design by detecting pressure points during extended use.
 - Postural Studies:* Evaluate seating positions to reduce fatigue and discomfort.

5.4.2 Strategies to Improve Vehicle Comfort

- **Suspension System Optimization:**

Implement advanced suspension technologies, such as active and semi-active suspension systems, to adapt to varying road conditions.

Use of lightweight and high-strength materials in suspension components to enhance shock absorption.

- **Noise Reduction Techniques:**

Incorporate sound-dampening materials like acoustic foams and laminates in the vehicle body.

Design aerodynamic profiles to minimize wind noise and improve cabin quietness.

- **Vibration Mitigation:**

Use dynamic vibration absorbers and tuned mass dampers to counteract unwanted oscillations.

Optimize tire designs and materials for reduced road-induced vibrations.

- **Climate Control Enhancements:**

Integrate zonal climate control systems for personalized comfort.

Employ advanced filtration systems to maintain air quality and reduce allergens.

- **Ergonomic Improvements:**

Develop adjustable seating with memory foam or gel-based cushions to accommodate diverse body types.

Implement intuitive interfaces for seat adjustment and climate controls.

5.4.3 Testing Under Various Running Conditions

- **Urban Driving:**

Evaluate comfort during frequent stops and starts, sharp turns, and slow speeds.

Measure the impact of uneven pavement and potholes on ride quality.

- **Highway Driving:**

Test at sustained high speeds to assess aerodynamic noise and vibration.

Analyze the stability and smoothness of long-distance travel.

- **Off-road Conditions:**

Examine suspension performance on rough terrains with larger obstacles and uneven surfaces.

Assess body roll and vehicle handling in extreme scenarios.

- **Weather Variability:**

Test the effectiveness of thermal systems and materials in extreme heat, cold, and humidity.

Evaluate windshield clarity, defrosting mechanisms, and climate controls during rain and snow.

5.4.4 Seat Comfort

- **Ergonomics:** Seats should support the body's natural posture, especially for long trips. This includes adjustable features like lumbar support, seat angle, and headrests.

- **Cushioning:** Softness and firmness of the seat cushions, which influence how the body feels after prolonged sitting.
- **Adjustability:** The range of adjustments for height, tilt, backrest, and leg support.

5.4.5 Ride Quality

- **Suspension System:** The suspension's ability to absorb bumps and road irregularities. A well-tuned suspension minimizes road feel and ensures a smooth ride.
- **Noise, Vibration, and Harshness (NVH):** Low levels of noise and vibration are crucial for comfort. This involves engine noise, road noise, and vibrations transferred through the chassis and wheels.
- **Road Handling:** Stability at high speeds and responsiveness to steering input, which can affect comfort by preventing unwanted oscillations or jerks.

5.4.6 Climate Control

- **Temperature Regulation:** The car's ability to maintain a comfortable interior temperature through heating, air conditioning, and ventilation systems.
- **Air Quality:** Effective filtration systems to remove allergens, pollutants, or excessive moisture from the cabin air.
- **Heated and Cooled Seats:** Features that allow users to adjust seat temperatures for additional comfort.
- **Space and Layout**
- **Legroom and Headroom:** Sufficient space for passengers in all seating positions, with consideration for both front and rear seats.
- **Seat Configuration:** Ease of access to seats and their ability to adjust for various passenger sizes.
- **Storage Space:** Adequate room for personal items, ensuring the cabin doesn't feel crowded.

5.4.7 Technology and Features

- **Infotainment System:** The quality, ease of use, and responsiveness of entertainment, navigation, and connectivity systems. Comfort is enhanced when these features are intuitive and seamlessly integrated.
- **Driver Assistance Features:** Adaptive cruise control, lane-keeping assist, and parking sensors can reduce driving stress and improve overall comfort.
- **Sound System**
- **Audio Quality:** High-quality speakers with clear, balanced sound can enhance comfort, particularly during long journeys.

5.4.8 Driving Experience

- **Steering:** The smoothness and responsiveness of the steering system, which should provide comfort during tight turns and long drives.

- **Acceleration and Braking:** Smooth and progressive responses from the throttle and brakes contribute to a more relaxing driving experience.
- **Seat Heating and Massage**
- **Massage Functions:** Some cars offer massaging seats that can be used during long drives to reduce fatigue.
- **Heated Seats:** Common in many cars, especially in cold climates, heated seats add a layer of comfort.

5.4.9 External Conditions

- **Weather Handling:** Cars designed to perform well in extreme conditions (such as high temperatures or snow) contribute to comfort by ensuring stable interior conditions regardless of outside weather.
- **Objective Measurement Techniques:**
- **Sensor-based analysis:** Instruments can measure the amount of noise, vibration, and motion transmitted through the car.
- **Ride Index:** Calculated by assessing the suspension's ability to dampen disturbances from the road.
- **Thermal Imaging:** Used to measure the interior temperature distribution, helping assess the effectiveness of the climate control system.

5.5 VEHICLE COMFORT PHENOMENA

Vehicle comfort refers to the overall experience of ease, relaxation, and safety that a passenger or driver feels while traveling in a vehicle. It encompasses various physical, sensory, and psychological factors that contribute to the satisfaction of the occupant. These factors can be divided into several categories, including ride quality, noise levels, ergonomics, climate control, and seat comfort, all of which interact to create the perception of comfort in a vehicle.

5.5.1 Ride Quality and Suspension System

The ride quality is one of the primary contributors to vehicle comfort. It is influenced by how the suspension system of the vehicle interacts with road irregularities. The suspension system is designed to minimize the impact of bumps, vibrations, and shocks, which can cause discomfort. This system consists of various components such as springs, shock absorbers, and dampers, which work together to absorb road disturbances. The comfort of the ride is largely influenced by the damping characteristics of the suspension system, the vehicle's ground clearance, and the type of tires.

There are two key aspects of ride quality: vertical acceleration and body roll. Vertical acceleration refers to the up-and-down movements of the vehicle as it encounters bumps, while body roll involves the side-to-side movements of the vehicle as it turns. Both of these aspects affect the comfort of the passengers. Ideally, the suspension

system should minimize both vertical and lateral movements, allowing the vehicle to glide over the surface smoothly.

5.5.2 Noise, Vibration, and Harshness (NVH)

Noise, vibration, and harshness (NVH) are critical factors that influence vehicle comfort. NVH encompasses the sounds and vibrations that arise from the engine, road surface, tires, and other moving components within the vehicle. High NVH levels can lead to discomfort, fatigue, and a generally unpleasant driving experience.

The noise level inside the cabin is affected by factors such as engine type (electric engines tend to produce less noise than internal combustion engines), tire type, the aerodynamics of the vehicle, and the materials used in the vehicle's construction. Engineers work to reduce the impact of NVH by using sound-deadening materials, designing quieter engines, and optimizing the aerodynamics of the vehicle to minimize wind noise.

Vibration is another crucial factor, particularly concerning the road surface. Vibrations can be transferred through the vehicle's frame and affect passenger comfort. These vibrations are minimized by optimizing the vehicle's suspension system and ensuring that the tires and wheels are balanced properly.

5.5.3 Climate Control and Air Quality

Comfort inside the vehicle is also strongly influenced by the interior climate, including temperature, humidity, and air quality. Modern vehicles are equipped with advanced climate control systems that allow the driver and passengers to adjust the temperature and airflow to their preference. A well-designed climate control system can maintain a consistent and pleasant cabin temperature, regardless of external weather conditions.

In addition to temperature control, air quality is also a key aspect of comfort. Pollutants such as dust, pollen, and vehicle emissions can compromise the air quality inside the cabin, leading to discomfort or even health concerns. Air filtration systems, such as HEPA filters, and the use of air purifiers can help to ensure that the air inside the vehicle is clean and fresh, contributing to a more comfortable driving experience.

5.5.4 Ergonomics and Seating Comfort

The design of the seats plays a significant role in vehicle comfort. Ergonomically designed seats can provide better lumbar support, improve posture, and reduce fatigue, especially during long journeys. Seat adjustments such as recline, height, lumbar support, and seat cushion firmness allow passengers to tailor the seating to their preferences, ensuring a more personalized and comfortable experience.

In addition to the physical design of the seat, the materials used also affect comfort. Premium vehicles may feature seats with memory foam, heated or cooled cushions, and massage functions, all of which enhance comfort. Seat belt tension and position are also

crucial for comfort, as they should provide a secure fit without causing pressure or discomfort during prolonged use.

5.5.5 Psychological Comfort

Psychological comfort is a more subjective element but is equally important. It refers to how secure and relaxed a person feels within the vehicle. Factors that contribute to psychological comfort include the vehicle's interior design, noise levels, smoothness of the ride, and safety features.

For instance, a spacious cabin with a quiet and smooth ride can provide a sense of calm and relaxation. Safety features such as advanced driver assistance systems (ADAS), which include lane-keeping assistance, adaptive cruise control, and automatic emergency braking, can enhance psychological comfort by giving passengers a sense of security. Additionally, advanced infotainment systems, which allow passengers to control music, navigation, and climate settings, add to the overall sense of well-being by offering greater convenience and control.

5.5.6 Technological Enhancements

Modern vehicles are increasingly equipped with technologies that further improve comfort. These include noise-canceling systems that reduce unwanted sounds in the cabin, adaptive suspension systems that automatically adjust to road conditions, and personalized climate control systems that can monitor and adjust the temperature for each passenger individually.

5.6 VEHICLE COMFORT IS A CRUCIAL FACTOR IN AUTOMOTIVE DESIGN, ENSURING A PLEASANT EXPERIENCE FOR DRIVERS AND PASSENGERS

To measure comfort, several factors such as ride quality, noise, vibration, seat ergonomics, and cabin climate must be evaluated. Below is a general method for measuring vehicle comfort:

5.6.1 Ride Quality Assessment

- **Objective:** To measure how smooth and stable the vehicle feels during different road conditions.
- **Method:**
 - ***Instrumented Testing:*** Use accelerometers and gyroscopes placed at key locations in the vehicle (e.g., seats, floor, dashboard) to record vibrations and motions during driving.
 - ***Suspension Dynamics:*** Measure the vertical and lateral accelerations while driving on different surfaces, such as smooth highways, rough roads, and uneven terrains.

Human Perception: Conduct subjective evaluations by having test subjects rate their perceived comfort using a Likert scale (e.g., from very uncomfortable to very comfortable).

ISO 2631 Standard: Follow this international standard to assess whole-body vibration exposure.

5.6.2 Noise Measurement

- **Objective:** To quantify the noise levels inside the cabin.
- **Method:**
 - Sound Level Meter:** Use a sound level meter to measure the decibel (dB) levels at different positions inside the cabin (e.g., front, rear, left, right).
 - Frequency Analysis:** Perform a frequency spectrum analysis to identify dominant noises, such as engine sound, tire noise, and wind noise.
 - Passenger Feedback:** Collect subjective feedback from passengers regarding noise annoyance.

5.6.3 Vibration Analysis

- **Objective:** To assess how vibrations from the engine, road, or other sources affect the occupants.
- **Method:**
 - Accelerometers:** Measure the vibrations on various vehicle components like seats, steering wheel, and pedals.
 - Frequency Range Analysis:** Analyze vibrations in different frequency ranges (low frequency for road vibrations, higher frequency for engine vibrations) to assess discomfort.

5.6.4 Seat Comfort Evaluation

- **Objective:** To determine the comfort level of the seats, which is influenced by their shape, material, and adjustability.
- **Methods:**
 - Pressure Mapping:** Use pressure sensors to map the distribution of pressure across the seat surface, ensuring even pressure distribution that prevents discomfort during long rides.
 - Seat Adjustability:** Evaluate the ease and range of adjustments for seat positions, lumbar support, and headrests.
 - Ergonomic Assessment:** Test seat design against ergonomic standards to ensure proper support for posture, especially for long-distance driving.

5.6.5 Climate Control Assessment

- **Objective:** To assess the air quality, temperature, and humidity within the cabin.
- **Methods:**
 - Temperature Sensors:** Place sensors in different cabin zones (driver's seat, passenger seat, rear seats) to monitor temperature variation.

Humidity and Air Quality Sensors: Measure cabin humidity levels and air pollutants like CO₂ and VOCs.

Airflow Patterns: Analyze the effectiveness of air conditioning and heating systems in maintaining comfortable cabin conditions.

5.6.6 Driver and Passenger Experience (Subjective Evaluation)

- **Objective:** To gather personal feedback about the comfort features of the vehicle.

- **Methods:**

Surveys and Questionnaires: Conduct surveys with passengers, asking for their overall comfort rating, including ride quality, seat comfort, noise, vibration, and cabin climate.

Focus Groups: Organize focus groups of typical users to get detailed feedback on specific aspects of vehicle comfort.

5.6.7 Long-Term Comfort Testing

- **Objective:** To assess comfort over extended periods of use, as short-term testing may not reflect long-term discomfort.

- **Method:**

Endurance Driving: Conduct long drives on various road conditions to measure discomfort from prolonged exposure to vibrations, noise, and seat ergonomics.

Fatigue Testing: Measure physical fatigue over longer durations to evaluate how the vehicle's comfort influences driver concentration and fatigue levels.

Data Integration and Comfort Index

- **Objective:** To combine the quantitative data and subjective evaluations into an overall comfort score.

- **Method:**

Comfort Index: Develop a composite score that incorporates all aspects of comfort (ride quality, noise, vibration, seat comfort, climate control, etc.) based on weighted criteria.

Statistical Analysis: Use statistical methods to correlate subjective passenger satisfaction with objective measurements to fine-tune comfort features.

5.7 VEHICLE INDICES USED TO EVALUATE COMFORT

Comfort in vehicles is an essential factor for both the driver and passengers. The experience of comfort involves not only physical aspects, such as seat quality and cabin space, but also psychological factors, such as noise levels and ride smoothness. Vehicle comfort indices are designed to quantify these aspects and provide an objective measure of a vehicle's ability to deliver a pleasant ride. These indices are commonly used by automotive manufacturers, reviewers, and consumers to assess comfort levels. Below are the key indices used to evaluate vehicle comfort.

5.7.1 Ride Quality Index (RQI)

Ride quality refers to how well a vehicle absorbs bumps, vibrations, and other irregularities in the road surface. This factor is heavily influenced by the vehicle's suspension system and the stiffness of its tires. The Ride Quality Index (RQI) is a numerical representation of a vehicle's ability to provide a smooth, pleasant ride. The index incorporates parameters such as the frequency and amplitude of vibrations felt inside the vehicle. A lower RQI indicates a smoother ride, while a higher value suggests more noticeable disturbances from the road surface.

The RQI is typically derived from testing conducted on various surfaces—smooth asphalt, rough concrete, and gravel roads. During these tests, a set of sensors, including accelerometers and microphones, measure the vehicle's movements and vibrations. Data are collected and analyzed to determine how these factors affect passenger comfort. In some systems, the RQI is weighted based on the relative importance of specific comfort features, such as low-frequency vibrations and high-frequency shocks.

5.7.2 Noise, Vibration, and Harshness (NVH) Index

NVH (Noise, Vibration, and Harshness) is one of the most important indices used to evaluate overall vehicle comfort. The NVH index takes into account the levels of sound and vibration that passengers are exposed to during a drive. A high NVH index suggests that a vehicle generates excessive noise, uncomfortable vibrations, and harsh handling, all of which can negatively impact comfort.

- **Noise:** This is measured through sound levels within the cabin during different driving conditions (idle, cruising, acceleration). The types of noise that are considered include engine noise, tire noise, wind noise, and road noise. Excessive cabin noise can lead to fatigue and discomfort, which is why a vehicle with a low NVH rating is highly desirable.
- **Vibration:** This refers to the intensity of mechanical vibrations transmitted through the vehicle's structure, especially through the floor and seats. These vibrations can be caused by the engine, transmission, suspension, or even road imperfections. Modern vehicles often use vibration-dampening materials to minimize these effects.
- **Harshness:** Harshness refers to sudden, jarring impacts felt by passengers, such as those caused by hitting a pothole or uneven road surface. It is closely related to ride quality but focuses more on abrupt and extreme forces rather than continuous vibrations.

NVH testing is typically done with a combination of microphones and accelerometers placed in strategic locations within the vehicle. These tools record both acoustic and vibrational data that are analyzed to derive the NVH index.

5.7.3 Seat Comfort Index

The seat comfort index is used to evaluate the ergonomic and comfort characteristics of a vehicle's seating. This index considers several factors that contribute to seat comfort:

- **Seat cushion:** The firmness or softness of the seat cushion plays a significant role in comfort. Too soft a cushion can lead to poor support, while too firm a cushion can cause discomfort during long rides. The optimal seat cushion firmness depends on factors like the type of driving (short vs. long trips) and the seat's ability to adapt to the passenger's body shape.
- **Back support:** Proper lumbar support is crucial for maintaining posture and reducing the risk of discomfort or pain in the lower back. The seat backrest's design, adjustability, and contouring all contribute to comfort. The seat comfort index takes into account the adjustability and ergonomics of the backrest to ensure it supports the spine correctly.
- **Adjustability:** A key aspect of seat comfort is how easily a seat can be adjusted. This includes not only basic adjustments like seat height, depth, and tilt, but also more advanced features like lumbar support adjustments and seat memory functions.

Comfort testing for seats involves measurements of pressure distribution, back support, and overall ergonomics using both human testers and specialized equipment such as pressure mapping systems and motion capture tools.

5.7.4 Cabin Space and Layout Index

Cabin space is another crucial aspect of comfort, as passengers need enough room to feel relaxed. The Cabin Space and Layout Index measures the overall space available inside the vehicle, considering aspects such as headroom, legroom, shoulder room, and overall interior volume. It also evaluates how efficiently the space is utilized and how comfortable passengers feel in relation to the vehicle's layout.

This index is often based on anthropometric data (measurements of human body dimensions) and ergonomic assessments. The cabin should accommodate a range of body types and provide ample space for passengers, especially for longer trips. In addition, the placement of seats, footrests, and controls can significantly influence the cabin comfort.

5.7.5 Climate Control Comfort Index

Another important comfort factor is the vehicle's climate control system. The Climate Control Comfort Index measures how well a vehicle maintains a comfortable internal temperature, airflow, and humidity levels. The system's ability to heat or cool the cabin efficiently without causing discomfort—such as excessive dryness or overcooling—is crucial to passenger comfort.

- **Temperature regulation:** This evaluates the system's ability to maintain a consistent cabin temperature, even when external conditions vary significantly.

- **Air circulation:** Proper air circulation ensures that cool or warm air reaches all areas of the cabin. A well-designed ventilation system provides comfort without creating drafts or hot spots.
- **Humidity control:** Too much humidity can cause discomfort, while too little can lead to dryness. Advanced climate control systems balance both factors for optimal comfort.

Climate control comfort is often measured in a controlled environment, where various temperatures and humidity levels are tested while recording the passengers' subjective comfort ratings.

5.7.6 Vehicle Handling and Stability Index

Although handling is more traditionally associated with performance, it can also play a role in comfort. The Vehicle Handling and Stability Index evaluates how well a vehicle handles turns, acceleration, and braking without causing discomfort to passengers. Poor handling can lead to jerky or unsettling movements that reduce overall comfort.

Handling factors, such as steering response, body roll during turns, and the ability to maintain stability under braking, are assessed. Vehicles with high stability and smooth handling characteristics provide a more comfortable experience for passengers, especially when navigating rough or winding roads.

5.8 VEHICLE DYNAMICS PERFORMANCE

Vehicle dynamics refers to the study of forces and motion as they relate to a vehicle's movement, stability, and control. It is a crucial field in automotive engineering, focusing on how vehicles interact with the road and how the driver's inputs affect vehicle behavior. Understanding vehicle dynamics performance is vital for designing vehicles that are safe, efficient, and provide optimal driving experiences. In this context, vehicle dynamics can be broadly divided into several key areas: longitudinal, lateral, and vertical dynamics.

5.8.1 Longitudinal Dynamics

Longitudinal dynamics refers to the movement of the vehicle along its direction of travel (forward or backward). Key factors influencing longitudinal dynamics include acceleration, braking, and engine performance. The performance in this area is often characterized by the vehicle's ability to accelerate, decelerate, and maintain stable speed. The major forces involved in longitudinal dynamics are:

- **Engine Power:** The engine's ability to generate power, typically measured in horsepower or kilowatts, dictates how quickly a vehicle can accelerate. The transmission system then determines how efficiently this power is transferred to the wheels.

- **Braking Force:** The ability of the vehicle to decelerate or stop efficiently depends on the braking system, which involves friction between the brake pads and the wheels, as well as the tire-road interaction.
- **Traction:** Traction is essential for transferring the forces required for acceleration and braking. The friction between the tires and the road surface influences the vehicle's ability to maintain stability during acceleration or braking.

In terms of performance, vehicles with high acceleration capabilities, robust braking systems, and superior traction will have enhanced longitudinal dynamics. For example, high-performance sports cars or electric vehicles with powerful motors often exhibit exceptional acceleration and deceleration characteristics.

5.8.2 Lateral Dynamics

Lateral dynamics concerns the movement of the vehicle in the direction perpendicular to its travel, specifically how it handles turning or cornering. The key factors influencing lateral dynamics include steering, tire-road interaction, and the distribution of weight across the vehicle. The performance of lateral dynamics is determined by the vehicle's ability to change direction efficiently and safely.

- **Steering Response:** The steering system influences how quickly and precisely the vehicle responds to the driver's input. Power steering systems, for instance, can provide varying levels of assistance, depending on the vehicle's speed and the amount of force the driver applies to the wheel.
- **Tire Performance:** The tires play a significant role in lateral dynamics, as their grip determines how well a vehicle can maintain control during cornering. High-performance tires provide better traction during sharp turns, but the limits of grip can lead to under steer (the vehicle turning less than the driver intends) or over steer (the vehicle turning more than the driver intends).
- **Suspension System:** The suspension system's role in lateral dynamics is crucial. It influences the vehicle's stability during cornering by minimizing body roll and maintaining tire contact with the road. A well-tuned suspension system ensures optimal handling and stability, particularly in high-speed maneuvers.

Vehicles designed for superior lateral dynamics, such as sports cars or racing vehicles, are engineered with specialized tires and advanced suspension systems to allow for precise handling and agility, especially on curves or tight corners.

5.8.3 Vertical Dynamics

Vertical dynamics involve the vehicle's movement in the vertical plane, especially in response to road imperfections like bumps, dips, and undulations. The forces experienced during these motions are primarily handled by the vehicle's suspension system, which works to maintain tire contact with the road for optimal grip. Vertical dynamics affect ride comfort, handling, and safety.

- **Suspension:** The suspension system's ability to absorb road irregularities is fundamental in managing vertical forces. Shocks and springs in the suspension system reduce the impact of bumps and dips, thereby improving ride quality and vehicle stability.
- **Weight Distribution:** The way weight is distributed across the vehicle affects its vertical dynamics. A vehicle with even weight distribution is generally more stable, especially in terms of braking, acceleration, and cornering.
- **Tire Characteristics:** The stiffness of the tires, as well as their interaction with the suspension system, plays a significant role in absorbing vertical forces and maintaining traction during changes in the road surface.

In high-performance vehicles, vertical dynamics are finely tuned to provide a balance between comfort and performance. Racing vehicles, for instance, use stiff suspensions to reduce body movement and improve handling at high speeds, while luxury cars focus more on comfort by incorporating softer suspensions to smooth out road imperfections.

5.8.4 Vehicle Stability and Handling

The overall stability and handling of a vehicle are critical to its performance. Stability refers to the ability of a vehicle to maintain its trajectory without excessive deviation, while handling pertains to the vehicle's responsiveness to steering input and its overall maneuverability.

- **Understeer and Oversteer:** Understeer occurs when the front tires lose grip during a turn, causing the vehicle to continue in a straight line despite the driver's attempt to turn. Oversteer, conversely, occurs when the rear tires lose grip, causing the vehicle to rotate more than intended. These phenomena are affected by the suspension tuning, weight distribution, and tire selection, and managing them is vital for achieving optimal handling characteristics.
- **Electronic Stability Control (ESC):** Modern vehicles are often equipped with ESC systems that help prevent loss of control during extreme driving conditions. By applying braking force to individual wheels, ESC can counteract oversteering or understeering, ensuring the vehicle stays on its intended path.
- **Aerodynamics:** Aerodynamic forces can also affect vehicle dynamics, particularly at high speeds. The design of the vehicle's body, including spoilers, diffusers, and other components, helps reduce lift and drag, improving stability and fuel efficiency.

5.9 VEHICLE PERFORMANCE

Vehicle performance is a comprehensive term that refers to how a vehicle operates in various conditions, measuring its overall efficiency, handling, speed, acceleration, and safety. The performance of a vehicle depends on various factors, including its engine design, drivetrain, aerodynamics, suspension, tires, and the technology used within the vehicle. This overview will break down the key elements that contribute to vehicle

performance, exploring aspects such as power, speed, acceleration, handling, fuel efficiency, and safety.

5.9.1 Engine and Power Output

The heart of any vehicle's performance is its engine. The engine's power output is usually expressed in horsepower (hp) or kilowatts (kW) and is a crucial measure of the vehicle's capability. The power produced by an engine determines how well a vehicle can accelerate, climb hills, and reach top speeds.

Modern vehicles are powered by internal combustion engines (ICE), electric motors, or hybrid systems that combine both. The performance of these engines can be influenced by factors such as engine displacement, the number of cylinders, turbocharging, and fuel type. For example, turbocharged engines use forced induction to increase the air intake into the engine, providing more power for a given engine size, while electric vehicles (EVs) often deliver instant torque, enabling rapid acceleration.

The torque output of an engine also plays a significant role in vehicle performance. Torque determines how much force the engine can apply to the wheels, affecting how quickly the vehicle can start from a stop or accelerate at higher speeds. Vehicles with higher torque tend to offer better towing capabilities and performance at lower speeds.

5.9.2 Acceleration and Top Speed

Acceleration is the measure of how quickly a vehicle can increase its speed, typically represented as the time it takes to go from 0 to 60 mph (0 to 100 km/h). A high-performance vehicle, especially sports cars, may achieve this in just a few seconds, thanks to lightweight construction and powerful engines. The acceleration capability of a vehicle is closely tied to its engine power, weight, and drivetrain configuration.

The top speed of a vehicle is another performance metric that indicates how fast it can travel under optimal conditions. While top speed is not always a priority for everyday vehicles, high-performance sports cars and supercars are designed with aerodynamics and powerful engines to achieve extreme speeds.

The performance of vehicles in acceleration and top speed is also affected by factors like transmission type (manual, automatic, or dual-clutch), weight distribution, and tire selection. For example, dual-clutch transmissions, which can shift gears faster than traditional manuals or automatics, enable quicker acceleration times.

5.9.3 Handling and Suspension

Handling refers to a vehicle's ability to respond to driver inputs and maintain control during various driving maneuvers, such as cornering, braking, and navigating rough terrain. The suspension system of a vehicle, which includes components such as shock absorbers, springs, and control arms, plays a significant role in handling.

A well-designed suspension system ensures that the tires maintain optimal contact with the road, which is crucial for stability and grip. In sports and performance vehicles, suspensions are often tuned to provide precise feedback and responsive handling, with adjustable settings for different driving conditions.

The vehicle's weight distribution also plays an important role in handling. Sports cars typically have a balanced front-to-rear weight ratio, allowing for superior cornering abilities. Vehicles with rear-wheel drive (RWD) or all-wheel drive (AWD) generally have better handling characteristics compared to front-wheel drive (FWD) vehicles, particularly in high-performance scenarios where power needs to be distributed to all four wheels for maximum grip.

5.9.4 Fuel Efficiency and Environmental Impact

While performance is often associated with power and speed, fuel efficiency has become an increasingly important factor in the overall assessment of vehicle performance. The efficiency of an engine determines how well it converts fuel into energy, and is usually measured in miles per gallon (mpg) or liters per 100 kilometers (L/100 km).

Vehicles that are designed with performance in mind tend to have lower fuel efficiency due to the higher power output and heavier components. However, advancements in hybrid and electric vehicle technology have led to vehicles that combine impressive performance with high fuel efficiency. For example, hybrid vehicles utilize a combination of an internal combustion engine and electric motors, improving fuel efficiency while still providing substantial power. Electric vehicles (EVs) often outperform traditional combustion engines in terms of energy efficiency, producing fewer emissions and offering lower operating costs.

The environmental impact of vehicle performance is also a key consideration. The growing demand for sustainability has led to the development of low-emission, fuel-efficient vehicles, with many automakers focusing on hybrid and fully electric solutions. With stricter environmental regulations worldwide, reducing carbon emissions and improving fuel efficiency are now central to vehicle performance.

5.9.5 Safety and Driver Assistance

Vehicle performance is not only about speed and handling but also includes safety. Advanced safety features such as anti-lock braking systems (ABS), electronic stability control (ESC), and traction control help maintain vehicle stability in challenging conditions. In addition, active safety technologies, such as lane-keeping assist, adaptive cruise control, and automatic emergency braking, are becoming standard in many new vehicles, improving driver confidence and reducing the likelihood of accidents.

In high-performance vehicles, safety considerations are especially important due to the increased speed and power. High-performance cars are often equipped with specialized

safety features, such as reinforced structures, advanced airbag systems, and high-performance tires that provide superior grip.

5.9.6 Technology Integration and Performance Monitoring

Modern vehicles are increasingly equipped with technology that enhances both performance and the driving experience. Infotainment systems, connectivity features, and performance monitoring tools are commonly found in performance-oriented vehicles. These technologies allow drivers to track performance metrics such as lap times, acceleration, and power output in real time.

In addition, software updates and vehicle diagnostics systems can help monitor engine performance and identify issues before they become serious problems, improving overall vehicle reliability and longevity. The integration of technology in the vehicle can enhance both the functional and entertainment aspects of performance, providing a more comprehensive driving experience.

5.10 EFFECT OF VERTICAL VIBRATION FREQUENCY IN VERTICAL DYNAMICS ANALYSIS

Vertical vibration frequency plays a crucial role in the vertical dynamics analysis of mechanical systems, particularly in areas such as structural engineering, vehicle dynamics, and machinery design. Understanding how the frequency of vertical vibrations impacts the behavior of these systems is vital for ensuring structural integrity, comfort, and efficiency. Vertical dynamics typically refers to the study of forces, displacements, and accelerations along the vertical direction of a system subjected to various vibrational frequencies. These vibrations are often caused by external excitations, such as road irregularities in vehicles or wind loads on structures, and can lead to resonance, fatigue, or instability if not properly controlled. This analysis considers the effects of vertical vibration frequencies on the system's performance and highlights critical factors such as natural frequency, resonance, and damping.

5.10.1 Vertical Vibration Frequency and System Behavior

In vertical dynamics, vibration frequency is typically categorized into two types: the natural frequency of the system and the excitation frequency. The natural frequency is an inherent property of a system determined by its mass and stiffness, while the excitation frequency is the frequency at which the system is subjected to external forces. The interaction between these two frequencies significantly influences the system's response.

5.10.2 Natural Frequency

Every system has a natural frequency at which it tends to oscillate when disturbed. For a simple vertical mass-spring system, the natural frequency (f_n) is given by the equation:

$$f_n = \frac{1}{2\pi} \sqrt{\frac{k}{m}} \quad (5.1)$$

where k is the stiffness of the system, and m is the mass. The vertical vibration frequency of the system can cause the system to resonate if the excitation frequency matches or is close to the natural frequency. Resonance amplifies the oscillations, leading to large displacements and, in the case of structures or machinery, potentially catastrophic failure.

For example, in vehicles, the resonance phenomenon can lead to excessive oscillations in the suspension system, affecting comfort and stability. In tall buildings, resonance due to wind forces can cause large sway, threatening the structural integrity. Therefore, it is critical to ensure that the operating frequency of any system is sufficiently different from its natural frequency, or damping is introduced to control resonance effects.

5.10.3 Excitation Frequency

The excitation frequency refers to the frequency at which external forces act on the system. In practical applications, this is usually caused by road imperfections, wind forces, or operational machinery vibrations. The vertical dynamics analysis involves determining how the excitation frequency interacts with the system's natural frequency.

If the excitation frequency closely matches the natural frequency, resonance occurs, leading to a significant amplification of oscillations. In contrast, if the excitation frequency is far from the natural frequency, the system exhibits smaller displacements and oscillations, which are less damaging.

The excitation frequency's impact is often seen in the design of transportation systems, such as trains, cars, and airplanes, where the suspension system must absorb vertical vibrations from the road or air turbulence. In these cases, the frequency of vibration induced by external forces is carefully analyzed to avoid resonant frequencies that could degrade comfort or lead to mechanical failures.

5.10.4 Resonance and Its Implications

Resonance occurs when the excitation frequency coincides with the system's natural frequency, causing the amplitude of oscillations to increase significantly. This phenomenon is a critical consideration in vertical dynamics, particularly in the design of buildings, bridges, vehicles, and rotating machinery.

In vehicles, for instance, resonance at a particular vertical frequency can lead to a situation where the oscillations of the suspension system become very large, negatively impacting ride quality and causing excessive wear on components. Similarly, in buildings and bridges, resonance could cause dangerous vibrations that exacerbate structural fatigue or lead to failure. For these reasons, engineers must ensure that the

design frequencies of components are sufficiently far from the natural frequency to avoid resonance, or they must implement damping systems to absorb the energy.

5.10.5 Damping and Control of Vibrations

Damping is a technique used to mitigate the effects of resonance by dissipating the energy generated by vibrations. In vertical dynamics analysis, damping plays an essential role in controlling the amplitude of oscillations and reducing the impact of resonance. Damping mechanisms can include materials with inherent damping properties, such as rubber or viscoelastic materials, or mechanical devices like shock absorbers and tuned mass dampers.

Damping systems are often designed to absorb the energy from external excitations, preventing the oscillations from growing to destructive levels. In vehicles, for example, the shock absorbers control the vertical vibration frequencies induced by road surface irregularities, ensuring that the system does not resonate. In buildings, tuned mass dampers are used to absorb wind-induced vibrations, preventing excessive sway and ensuring structural safety.

5.11 EFFECT OF VERTICAL VIBRATION FREQUENCY IN FULL CAR

Vertical vibration frequencies in full car systems significantly influence the comfort, performance, and durability of vehicles. These vibrations occur primarily due to road irregularities and the interaction between the vehicle's suspension system and the road surface. When a vehicle encounters bumps or uneven surfaces, the suspension absorbs these vertical movements, and the frequency of these vibrations plays a crucial role in the overall driving experience. This paper explores the effect of vertical vibration frequencies in full car systems from both a theoretical and practical perspective.

5.11.1 Basic Concept of Vertical Vibration Frequency

Vertical vibrations in a full car system are mainly caused by the interaction between the car's wheels and the road surface. The vehicle's suspension system, consisting of springs, dampers, and shock absorbers, is designed to mitigate the effects of these vibrations. The frequency of vertical vibrations can be categorized into two main components:

- **Natural Frequency of the Suspension System:** This is the frequency at which the vehicle's suspension oscillates when displaced from its equilibrium position. It depends on the stiffness of the springs and the damping characteristics of the shock absorbers.
- **Excitation Frequency from Road Surface:** This is the frequency at which the road surface induces vertical motion in the car. It varies with road conditions, speed, and tire characteristics.

The interaction between these two frequencies determines the overall behavior of vertical vibrations in a full car system. If the road excitation frequency coincides with the natural frequency of the vehicle's suspension, resonance can occur, amplifying vibrations and leading to uncomfortable ride conditions or even structural damage.

5.11.2 Impact on Ride Comfort

Ride comfort is a primary concern when evaluating the effect of vertical vibration frequency in a full car. Human passengers are sensitive to vibrations that fall within certain frequency ranges, particularly those between 0.5 Hz and 10 Hz, where the human body's natural resonance frequencies lie. The suspension system must therefore be designed to absorb vibrations within this range to maintain comfort.

- **Low-Frequency Vibrations (0.5 Hz to 2 Hz):** These vibrations are often associated with large road undulations, such as those found in uneven or poorly maintained roads. They can cause a "bouncing" sensation, which leads to discomfort over long periods.
- **Mid-Frequency Vibrations (2 Hz to 4 Hz):** These frequencies are more commonly encountered with typical road irregularities and can cause fatigue and discomfort for passengers.
- **High-Frequency Vibrations (above 4 Hz):** High-frequency vibrations usually result from minor road imperfections and are typically absorbed well by the suspension system. However, when these frequencies coincide with the natural frequency of the car's suspension, it may lead to discomfort and noise.

To optimize ride comfort, car manufacturers often tune the suspension system's damping characteristics and spring stiffness to attenuate these frequencies and prevent the uncomfortable effects of resonance.

5.11.3 Influence on Vehicle Handling and Stability

Apart from passenger comfort, the frequency of vertical vibrations also affects vehicle handling and stability. The suspension system not only isolates the cabin from road irregularities but also maintains tire contact with the road, ensuring good traction and stability.

- **Low-Frequency Vibrations:** When the vertical vibration frequency is low, the suspension may struggle to keep the tires in consistent contact with the road surface. This can cause a loss of traction, affecting the vehicle's stability, particularly during turns or rapid accelerations.
- **High-Frequency Vibrations:** On the other hand, excessively high-frequency vibrations can lead to reduced handling performance as the suspension becomes overly stiff, preventing it from adjusting to road surface changes in real time. This can make the vehicle feel rigid and unresponsive, particularly in dynamic driving situations.

Proper tuning of the suspension system's response to vertical vibrations ensures that handling characteristics are optimized, contributing to both comfort and vehicle control.

5.11.4 Resonance and Its Effects

One of the most critical phenomena related to vertical vibration frequency is resonance. Resonance occurs when the frequency of road-induced vibrations matches the natural frequency of the car's suspension system. This can lead to a significant amplification of the vibrations, making the car ride uncomfortable and potentially causing damage to the suspension components, chassis, and other parts of the vehicle.

- **Resonance in Full Car Systems:** The risk of resonance is particularly high in full car systems that are not designed to account for road excitation frequencies. If the suspension system resonates with road-induced vibrations, it can lead to excessive displacement, causing more force to be transmitted to the vehicle's body and increasing the likelihood of structural damage.

To avoid resonance, vehicle manufacturers carefully design suspension systems with appropriate damping to ensure that the natural frequency of the suspension is distinct from typical road excitation frequencies. Active suspension systems are also being developed that can adjust the stiffness of the suspension in real time to further mitigate the effects of resonance.

5.11.5 Durability and Structural Integrity

Vertical vibrations, especially those of higher amplitude or frequency, also affect the durability and structural integrity of a vehicle. Repeated exposure to high-frequency vibrations can cause fatigue in various components of the suspension system, frame, and other structural elements. The vibrations can lead to the loosening of joints, bolts, and other fasteners, resulting in mechanical failures over time.

Moreover, vertical vibrations can influence the lifetime of tires, shock absorbers, and springs. Proper suspension tuning and vibration isolation are critical for extending the lifespan of these components and preventing costly repairs.

5.12 SUSPENSION DEFLECTION IN A FULL CAR:

Suspension deflection is a crucial concept in vehicle dynamics, particularly when it comes to understanding how a car's suspension system responds to road irregularities, impacts, and various driving conditions. In a full car, suspension deflection refers to the movement or displacement of the suspension components under load, which can affect both ride comfort and handling performance. This phenomenon involves several interconnected factors, including the properties of the suspension components, the weight distribution of the car, and the road conditions. Below, we will explore suspension deflection in detail, its causes, and its impact on the performance of a vehicle.

5.12.1 Suspension System Basics

At the heart of a car's suspension system are the springs and dampers, which work together to provide support, absorb shock, and maintain tire contact with the road. The primary function of the suspension is to minimize the impact of road irregularities on the vehicle's chassis, ensuring comfort and control. The springs, which can be either coil, leaf, or air springs, support the vehicle's weight and store energy when compressed. Dampers (or shock absorbers) control the rate at which the springs compress and rebound, preventing excessive oscillation and ensuring that the vehicle maintains stability.

In the context of suspension deflection, when the vehicle encounters a bump or uneven surface, the spring compresses and then decompresses, causing a deflection in the suspension. The degree of this deflection depends on factors such as the type of spring used, its stiffness (spring constant), the load applied, and the overall geometry of the suspension system.

5.12.2 Factors Affecting Suspension Deflection

Several factors contribute to the amount of suspension deflection a vehicle experiences:

- **Vehicle Weight and Load Distribution:** The weight of the vehicle plays a critical role in determining suspension deflection. A heavier vehicle or one with uneven load distribution will exert more force on the suspension system, causing greater deflection. For example, a fully loaded car will experience more deflection than an empty one. The deflection also depends on how the weight is distributed across the front and rear axles, as well as side to side.
- **Spring Stiffness:** The stiffness of the suspension springs is a key factor in controlling deflection. Softer springs (lower spring rate) allow for more deflection, providing a smoother ride but compromising handling, especially in performance vehicles. Stiffer springs resist deflection, providing better handling but a harsher ride. The suspension design must balance comfort and performance depending on the vehicle's intended use.
- **Damping Characteristics:** The dampers or shock absorbers control the rate at which the springs deflect and return to their neutral position. Under- or over-damping can cause excessive deflection or inadequate absorption of shock, respectively. The proper damping ensures that suspension deflection is controlled in a way that maximizes both ride comfort and vehicle stability.
- **Suspension Geometry:** The design and configuration of the suspension, such as the length and angle of control arms, affect how suspension deflection occurs. A well-designed geometry can optimize the movement of the suspension components, ensuring that the wheels stay in contact with the road and the vehicle maintains stability.
- **Road Surface:** The type of terrain or road surface also impacts suspension deflection. On rough roads, the suspension will experience more deflection due

to increased bumps and irregularities. On smoother roads, deflection is minimal, and the suspension operates closer to its normal state.

- **Wheel and Tire Characteristics:** The tires themselves also influence how suspension deflection occurs. A tire with a higher sidewall and more pliable rubber can absorb some of the forces before the suspension components need to act. In contrast, low-profile tires with stiffer sidewalls will pass more of the impact to the suspension.

5.12.3 Mathematical Representation of Suspension Deflection

To quantify suspension deflection, one can use Hooke's Law, which describes the relationship between the force applied to a spring and its deflection:

$$\delta = \frac{F}{k} \tag{5.2}$$

Where:

- δ is the deflection,
- F is the force applied (in Newtons),
- k is the spring constant (in Newtons per meter).

The total deflection in the vehicle's suspension system can be the sum of deflections at the front and rear suspensions, considering the load distribution and spring stiffness. For more complex suspension designs, the deflection can be calculated numerically, often using simulations based on the specific geometry and material properties of the suspension components.

5.12.4 Impact of Suspension Deflection on Vehicle Performance

- **Ride Comfort:** The deflection of the suspension system plays a significant role in how comfortable the ride is for passengers. Excessive deflection can lead to a bouncy ride, while too little deflection can result in a harsh, uncomfortable experience, especially on uneven roads. Suspension systems that are designed with appropriate deflection characteristics can smooth out the impact from bumps, providing a better ride.
- **Handling and Stability:** Suspension deflection also affects handling and vehicle stability. If the suspension deflects too much, the tires may lose contact with the road, reducing traction and making the vehicle harder to control. Conversely, if the suspension is too stiff, it may not allow enough deflection to handle rough surfaces properly, causing a loss of comfort and potentially reducing grip.
- **Wear and Tear:** Continuous and excessive deflection can lead to increased wear on suspension components, particularly springs, shock absorbers, and bushings. Properly tuned suspension deflection reduces the risk of premature component failure and maintains vehicle performance over time.

- **Road Holding:** Deflection affects how well the car maintains tire contact with the road surface. The suspension must allow for some deflection to keep the tires in optimal contact, but excessive deflection can cause the vehicle to lose road contact, especially when cornering or during quick maneuvers.

5.13 RMS VERTICAL BODY ACCELERATION

5.13.1 RMS Vertical Body Acceleration

In engineering, especially in the context of vehicle dynamics and human comfort, understanding the body acceleration is essential for assessing how forces affect both the vehicle and its occupants. Among the various types of accelerations encountered, vertical body acceleration plays a significant role in determining ride quality and stability. Vertical body acceleration refers to the acceleration in the up-and-down direction experienced by a body, such as an individual inside a vehicle or the vehicle itself. It is important because it can influence the comfort of the passengers and also provides critical information for designing systems that mitigate discomfort or potential harm.

Root Mean Square (RMS) vertical body acceleration is one of the key metrics used to quantify the impact of vertical motion. It is a mathematical measure that represents the magnitude of acceleration as an average, accounting for both the magnitude and the direction of motion. The RMS value is particularly useful in evaluating the severity of oscillations and vibrations, which are common in vehicles navigating rough terrain or experiencing irregular road surfaces.

5.13.2 The Concept of RMS in Vertical Body Acceleration

The RMS (Root Mean Square) value is a statistical measure commonly used in fields such as physics and engineering to represent the average magnitude of a varying quantity, particularly when dealing with oscillatory or fluctuating signals. It is a more accurate representation of the overall effect of acceleration on the body, as opposed to simple averaging, because it accounts for both positive and negative values in the signal.

In the case of vertical body acceleration, the motion is generally oscillatory, meaning it alternates between upward and downward directions. The acceleration in these cases can vary in both magnitude and direction over time, such as when a vehicle rides over bumps or through potholes. The RMS value of the vertical body acceleration helps to quantify this fluctuation in a meaningful way that can be used to assess comfort, predict motion sickness, or design more effective suspension systems.

5.13.3 Significance of RMS Vertical Acceleration in Vehicle Dynamics

In automotive engineering, the RMS vertical body acceleration plays a crucial role in determining the quality of a vehicle's suspension system and its ability to absorb shocks from road irregularities. A vehicle's suspension system is designed to minimize the

effects of vertical acceleration on passengers by damping out high-frequency oscillations, providing a smoother ride.

However, if the RMS vertical body acceleration exceeds certain thresholds, passengers may experience discomfort or even motion sickness, especially during long trips. As such, the RMS acceleration is often used as a metric for designing vehicles that maximize ride comfort, particularly for luxury or passenger vehicles. For example, a high RMS value might indicate that the suspension system is not adequately absorbing road shocks, while a low RMS value typically indicates a smoother ride.

Moreover, in safety-critical applications such as aerospace engineering, RMS vertical acceleration is used to assess the forces acting on both the vehicle and its occupants. For example, in aircraft design, extreme vertical acceleration could have adverse effects on the comfort and safety of passengers, especially during turbulence or in cases of emergency maneuvers. Therefore, ensuring that the RMS acceleration remains within acceptable levels is a key design consideration.

5.13.4 Human Comfort and Health Considerations

The human body has limits to the amount of vertical acceleration it can tolerate without experiencing discomfort or adverse health effects. Studies have shown that vertical acceleration in vehicles can lead to a range of symptoms, including nausea, dizziness, and fatigue, particularly if the acceleration exceeds certain thresholds or if it persists over extended periods. This is particularly important for transportation systems that operate in environments where passengers might experience prolonged vertical accelerations, such as high-speed trains, aircraft, or boats.

From a physiological standpoint, vertical accelerations above a certain RMS value can result in motion sickness, especially in individuals who are sensitive to such movements. The severity of motion sickness increases with higher RMS acceleration values, especially in the low-frequency range of vibrations (below 1 Hz). By analyzing the RMS vertical body acceleration, engineers can design control systems and damping mechanisms that reduce the likelihood of such issues, improving the overall comfort and safety of the passengers.

5.13.5 Applications of RMS Vertical Acceleration

RMS vertical body acceleration finds wide applications across various fields beyond automotive and aerospace industries. In railway transportation, for example, understanding the RMS vertical acceleration helps optimize the ride quality of trains, which often travel on tracks with varying levels of smoothness. The rail industry uses RMS values to assess how different train types and suspension designs affect passenger comfort.

In off-road vehicles and heavy equipment, where the terrain is rough and unpredictable, minimizing RMS vertical acceleration is vital for ensuring the stability and safety of the

vehicle. Excessive vertical motion can cause instability, making the vehicle harder to control and increasing the likelihood of accidents.

Furthermore, RMS vertical acceleration is used in the evaluation of sports equipment and performance in contexts such as motorsports and mountain biking, where vertical accelerations are experienced frequently due to jumps or uneven surfaces.

The root mean square (RMS) acceleration is a measure of the average acceleration in a system that undergoes varying acceleration over time. It is defined as the square root of the mean of the squares of the instantaneous acceleration values.

Mathematically, the RMS acceleration is given by:

$$RMS = \sqrt{\frac{1}{T} \int_0^T a(t)^2 dt} \quad (5.3)$$

where:

- $a(t)$ is the instantaneous acceleration as a function of time,
- T is the time period over which the acceleration is measured,
- RMS is the root mean square acceleration.

This formula gives a value representing the effective magnitude of the varying acceleration over time.

5.14 ROAD HOLDING TO ASSESS COMFORT IN A FULL CAR

Road holding is a crucial characteristic of a vehicle that influences its driving performance, safety, and comfort. It refers to the vehicle's ability to maintain a stable and controlled motion on various road surfaces, especially while navigating turns, changes in elevation, or uneven terrain. When assessing road holding, one must consider a range of factors, including tire grip, suspension design, vehicle weight distribution, and aerodynamics. Road holding is not only important for high-performance vehicles but also plays a significant role in the comfort of passengers, particularly in a full car, where comfort can be affected by how well the vehicle handles these forces.

5.14.1 Tire Grip and Road Surface Interaction

Tires are the primary interface between the vehicle and the road surface. The quality and condition of the tires, along with their design, play a significant role in road holding. In a full car, where the weight distribution can be uneven due to the number of passengers, the tires need to perform optimally to ensure stability. Tire pressure is critical; under-inflated or over-inflated tires can adversely affect road holding, leading to a rougher ride and potential loss of control. Tires with a greater surface area in

contact with the road and those designed with compounds suited to the expected road conditions provide better grip, which translates to smoother handling and enhanced comfort.

The road surface itself also influences how well the vehicle holds the road. A smooth, dry surface will allow better tire traction than a wet or rough road. However, when the car is full, the load distribution changes, affecting how each tire interacts with the surface. The vehicle must be equipped with tires that can adapt to these variations to maintain smooth motion and avoid excessive vibrations or jolts.

5.14.2 Suspension System and Comfort

The suspension system of a vehicle is responsible for absorbing the impacts of road irregularities and maintaining tire contact with the road. In a full car, the additional weight changes the load distribution, putting more strain on the suspension components. A well-designed suspension system helps to maintain balance, reduce body roll, and dampen shocks, ensuring a smooth ride for all passengers. When assessing comfort in a full car, it's essential to examine how well the suspension can handle the extra load without compromising the ride quality.

There are different types of suspension systems, such as independent suspension, multi-link suspension, and air suspension, each offering varying levels of comfort. Air suspension systems, in particular, are known for their adaptability. They can adjust the ride height and firmness based on the load, ensuring optimal comfort regardless of the number of passengers in the vehicle. A car with poor suspension tuning may exhibit excessive bouncing or a harsh ride when fully loaded, which can result in discomfort for passengers, especially on uneven road surfaces.

5.14.3 Vehicle Weight Distribution and Stability

A well-balanced vehicle ensures optimal road holding and comfort. In a full car, the distribution of weight becomes more important because the added passengers affect the balance of the car. If the weight is not evenly distributed, it can lead to an imbalance in handling, making the car more prone to under-steering or over-steering during maneuvers. A car that is overloaded at the rear or front may struggle to maintain stable road holding, leading to swaying or discomfort during turns and curves.

For instance, if the rear of the vehicle is too heavy, the front wheels may lose traction, making steering less responsive. This can make the car feel unsteady, leading to an uncomfortable ride for passengers. On the other hand, excessive weight in the front can cause the rear to lift, reducing the effectiveness of the rear tires and compromising road holding. Ideally, a car should be designed with a near 50/50 weight distribution to ensure that the vehicle remains stable and balanced, even when fully loaded.

5.14.4 Aerodynamics and High-Speed Stability

Aerodynamic factors can also impact road holding and comfort, particularly at higher speeds. Vehicles are designed with aerodynamics in mind to reduce air resistance and maintain stability. When a car is full, the additional weight and potential change in its profile can affect its aerodynamic efficiency. This may lead to a slight increase in drag, which can influence fuel efficiency and high-speed stability.

At higher speeds, a vehicle's ability to maintain stable road holding is influenced by downforce generated by its aerodynamic components. A vehicle that lacks sufficient down force may exhibit instability, particularly when navigating windy conditions or high-speed corners. For the passengers, this translates to a ride that may feel jittery or uncomfortable. A full car, especially when traveling at highway speeds, requires a well-engineered design that compensates for these changes and ensures a smooth, controlled experience.

5.14.5 Braking Performance and Comfort

Road holding is also closely related to a vehicle's braking performance. In a full car, the increased weight places more demand on the braking system. To assess road holding and comfort, one must evaluate the vehicle's ability to decelerate efficiently without causing undue discomfort. A car that is poorly designed in terms of braking performance may exhibit harsh braking, leading to abrupt decelerations that disturb the passengers' comfort.

Advanced braking technologies, such as anti-lock braking systems (ABS) and electronic stability control (ESC), help maintain stability and smoothness during braking. These systems allow the vehicle to decelerate without excessive nosedive or abrupt stops, contributing to a more comfortable ride for everyone in the car.

5.15 OVERALL VEHICLE PERFORMANCE:

The overall performance of a vehicle encompasses multiple factors that influence how it operates, handles, accelerates, and delivers a driving experience. These factors include engine performance, fuel efficiency, handling, braking, comfort, and safety features. A vehicle's performance is the result of the intricate interaction between mechanical components, design, technology, and user experience. This overview will address the key elements that define the performance of a modern car, from its power train to its technological features, providing a complete picture of how these elements combine to enhance overall driving experience.

5.15.1 Power train and Engine Performance

The power train is the heart of any vehicle and plays a central role in defining its performance. It consists of the engine, transmission, driveshafts, and other key components that work together to produce and transmit power to the wheels.

- **Engine Type and Performance:** The type of engine (e.g., internal combustion engine, electric motor, or hybrid system) significantly influences a vehicle's performance. Internal combustion engines (ICE) can range from small, fuel-efficient engines to large, high-performance engines like V8s or V12s. Electric vehicles (EVs), on the other hand, often feature instant torque delivery, providing rapid acceleration and smoother performance. Hybrid systems combine both, offering improved fuel efficiency with the performance benefits of electric power.
- **Horsepower and Torque:** Horsepower refers to the engine's ability to perform work over time, while torque measures the engine's rotational force. Both of these parameters are crucial for acceleration, towing capacity, and overall performance. A higher horsepower often translates into quicker acceleration, while torque plays a critical role in low-end power delivery and driving dynamics, particularly in trucks and SUVs.
- **Transmission Systems:** The transmission is responsible for controlling the power delivered from the engine to the wheels. Manual transmissions, while offering more control, are less common in modern vehicles. Automatic and continuously variable transmissions (CVT) have become more widespread due to their convenience, smooth shifting, and efficiency. Dual-clutch transmissions (DCTs) are popular in high-performance and sports cars due to their rapid shifting capabilities.

5.15.2 Handling and Suspension

The vehicle's suspension system and handling characteristics dictate how well it responds to driving inputs, road conditions, and the driving environment. A well-tuned suspension can drastically improve comfort, stability, and performance.

- **Suspension Types:** Vehicles typically feature either independent suspension (where each wheel is connected to the body independently) or solid axle suspension (where the axle links the two wheels together). Independent suspension systems offer superior handling, comfort, and cornering ability, which is a major advantage in sports cars and luxury sedans.
- **Suspension Tuning:** The stiffness of the suspension and its damping properties significantly influence handling. A sportier vehicle may use stiffer suspension settings for better cornering control, while luxury vehicles focus on softer suspension for greater comfort. Adaptive suspension systems are becoming more common, offering adjustable settings that allow drivers to choose between comfort and performance.
- **Chassis and Body Control:** The design and material used in a car's chassis (steel, aluminum, or carbon fiber) impact the overall weight distribution and rigidity. Lighter materials enhance agility, while a rigid chassis allows for more precise handling. A balanced weight distribution between the front and rear axles improves stability, particularly during high-speed cornering.

5.15.3 Braking and Safety Performance

Braking performance is critical to a vehicle's overall safety and performance. The ability to slow down or stop quickly and safely is one of the most important aspects of any car's design.

- **Brake Types:** Modern cars typically use disc brakes, with larger vehicles using ventilated or perforated discs to dissipate heat. Performance-oriented vehicles often feature carbon-ceramic brakes, which provide superior heat resistance and braking power. Electric vehicles commonly use regenerative braking systems, which recover energy during braking to recharge the battery.
- **Anti-lock Braking System (ABS):** ABS prevents the wheels from locking up during hard braking, maintaining steering control and reducing the risk of skidding. This system is now a standard feature on most modern vehicles and is especially important in emergency situations.
- **Safety Features:** Beyond braking, vehicles are equipped with a variety of active and passive safety features. These include airbags, stability control, traction control, collision avoidance systems, lane-keeping assistance, and adaptive cruise control. These systems enhance overall vehicle performance by ensuring that the driver can maintain control, even in challenging driving conditions.

5.15.4 Fuel Efficiency and Environmental Impact

Fuel efficiency is a key metric for evaluating overall vehicle performance, especially in the context of rising environmental concerns and fuel prices. Fuel-efficient vehicles consume less fuel to cover the same distance, which lowers operating costs and reduces the environmental impact.

- **Fuel Economy:** Measured in miles per gallon (mpg) for gasoline vehicles or miles per gallon equivalent (MPGe) for electric vehicles, fuel economy is a reflection of how efficiently a car uses energy. Hybrid vehicles tend to have the best fuel efficiency, as they combine the internal combustion engine's range with the efficiency of an electric motor.
- **Emissions:** Modern vehicles are designed to minimize harmful emissions, adhering to strict environmental regulations. Electric vehicles produce zero tailpipe emissions, which makes them a cleaner alternative to traditional gasoline-powered cars. Hybrid vehicles reduce emissions compared to conventional cars, as they can operate on electricity for short trips and rely on gasoline for longer distances.

5.15.5 Technological Features and Comfort

The inclusion of advanced technologies in modern vehicles has greatly enhanced both performance and the driving experience.

- **Infotainment Systems:** Cutting-edge infotainment systems include navigation, connectivity (such as Apple Car Play and Android Auto), and voice recognition, allowing drivers to access information and entertainment without distraction. High-quality audio systems, touch screens, and intuitive interfaces contribute to an enhanced driving experience.

- **Driver Assistance Systems:** Advanced driver-assistance systems (ADAS) like lane-keeping assist, adaptive cruise control, and automatic parking enhance both performance and safety. These systems help drivers stay in control of the vehicle, reduce fatigue, and avoid accidents.
- **Comfort Features:** Modern vehicles are designed with driver and passenger comfort in mind. Climate control systems, leather seating, adjustable seats, and noise-reducing technology ensure a smooth and enjoyable ride.

5.16 COMMERCIAL MOTOR VEHICLES (CMV) ON INDIAN RURAL ROADS

India, with its vast network of over 63 lakh kilometers of roadways, is one of the largest and most intricate road systems in the world. A significant portion of this network connects rural areas, which constitute nearly 65% of the population. Commercial motor vehicles (CMVs) play a vital role in the transportation of goods and passengers across these rural regions, fostering economic growth and connectivity. However, the growth of CMVs on rural roads in India brings about numerous challenges that range from infrastructural inadequacies to regulatory non-compliance. Addressing these challenges requires a holistic approach, including regulatory reforms, infrastructural development, and community engagement.

5.16.1 Role of Commercial Motor Vehicles in Rural Development

Commercial motor vehicles form the backbone of rural economies by ensuring the seamless movement of agricultural produce, construction materials, and other essential goods. They also facilitate passenger transport, thereby enhancing access to education, healthcare, and employment opportunities. The presence of CMVs in rural areas promotes local entrepreneurship by connecting markets and enabling small-scale industries to flourish.

Despite these contributions, the integration of CMVs into rural road networks is far from seamless. Rural roads, often characterized by narrow and unpaved surfaces, pose significant obstacles to the efficient and safe operation of commercial vehicles. This harmony between the importance of CMVs and the inadequacies of rural road infrastructure underpins the need for strategic interventions.

5.16.2 Key Challenges Faced by CMVs on Rural Roads

- ***Inadequate Road Infrastructure:*** A large proportion of rural roads in India are not designed to withstand the weight and frequency of heavy commercial vehicles. Potholes, erosion, and insufficient width are common, leading to accidents and vehicle breakdowns. The lack of proper drainage exacerbates the problem, causing further degradation during monsoon seasons.
- ***Overloading and Vehicle Condition:*** Overloading is a rampant issue in rural transport, driven by the desire to maximize profit margins. Overloaded vehicles place additional strain on already fragile roads, accelerating their deterioration.

Additionally, many CMVs operating in rural areas are old and poorly maintained, increasing the risk of mechanical failures and road mishaps.

- **Lack of Enforcement and Regulatory Oversight:** Enforcement of road transport regulations is less stringent in rural areas compared to urban centers. Insufficient policing and corruption allow CMV operators to bypass essential safety and operational standards. This regulatory gap contributes to unsafe driving practices and the neglect of vehicle maintenance.
- **Road Safety Concerns:** The interaction between slow-moving agricultural vehicles, pedestrians, and high-speed CMVs often results in accidents. The absence of proper signage, lighting, and designated pedestrian pathways compounds the risk. Furthermore, the lack of emergency response services in remote regions prolongs the impact of accidents.
- **Environmental Impact:** Poorly maintained CMVs are significant contributors to air and noise pollution in rural areas. The emission of harmful pollutants from aging diesel engines not only affects the health of rural populations but also contributes to environmental degradation.

5.16.3 Government Regulations and Policies

To address these challenges, the Indian government has instituted various regulations and policies aimed at improving the safety and efficiency of CMVs on rural roads. The Motor Vehicles Act, 1988, forms the cornerstone of road transport regulations in India, covering aspects such as vehicle registration, fitness certification, and road safety.

- **Vehicle Fitness and Inspection:** The Motor Vehicles Act mandates periodic fitness tests for commercial vehicles to ensure roadworthiness. However, the implementation of these tests in rural areas remains inconsistent. The government's push for automated vehicle inspection centers aims to bridge this gap by ensuring more rigorous and unbiased testing.
- **Overloading Penalties:** Stringent penalties for overloading have been introduced to deter operators from exceeding permissible load limits. The enforcement of weighbridges at strategic points on rural highways seeks to curb overloading. Nevertheless, the reach of such facilities in remote areas is limited.
- **Road Development Programs:** Initiatives such as the Pradhan Mantri Gram Sadak Yojana (PMGSY) have significantly improved rural road infrastructure by connecting remote villages with all-weather roads. This program aims to create a more robust rural road network capable of accommodating commercial vehicles.
- **Training and Licensing:** The Ministry of Road Transport and Highways (MoRTH) has introduced driver training programs to enhance the skills and knowledge of CMV operators. Special emphasis is placed on defensive driving techniques, vehicle maintenance, and adherence to traffic regulations.
- **Technology Integration:** The adoption of GPS tracking and electronic toll collection systems is gradually extending to rural transport networks. These

technologies not only enhance the efficiency of commercial transport but also facilitate better monitoring and enforcement of regulations.

5.16.4 Community and Private Sector Involvement

Public-private partnerships (PPPs) have emerged as a viable model for enhancing rural road infrastructure and transport services. By leveraging private sector expertise and investment, the government can expedite the development and maintenance of rural roads. Additionally, community participation in road maintenance projects fosters a sense of ownership and ensures that local needs are addressed.

5.16.5 Future Outlook and Recommendations

The future of commercial motor vehicles on Indian rural roads hinges on the continued modernization of infrastructure, the enforcement of stringent regulations, and the adoption of sustainable transport practices. Key recommendations include:

- ***Expansion of Road Networks:*** Accelerating the implementation of rural road development programs to ensure comprehensive connectivity.
- ***Enhancing Enforcement Mechanisms:*** Deploying mobile enforcement units equipped with modern technology to conduct random vehicle inspections and enforce safety regulations.
- ***Incentivizing Fleet Modernization:*** Providing subsidies and financial incentives for the replacement of outdated commercial vehicles with newer, environmentally friendly models.
- ***Road Safety Awareness Campaigns:*** Launching awareness campaigns to educate rural populations about road safety and the importance of adhering to traffic regulations.
- ***Sustainable Practices:*** Promoting the use of electric and hybrid commercial vehicles in rural transport to reduce the environmental impact.

Therefore, Commercial motor vehicles play an indispensable role in the economic development of rural India. However, the challenges associated with their operation on rural roads necessitate a multifaceted approach that combines infrastructural development, regulatory reforms, and community engagement. By addressing these challenges, India can unlock the full potential of its rural road network, fostering economic growth and improving the quality of life for millions.

CHAPTER 6

PERFORMANCE ANALYSIS UNDER VARYING CONDITIONS

The efficient operation of high-speed vehicles on rural roads presents a unique set of challenges, distinct from those encountered on highways, expressways, super expressways, and district roads. In this context, it becomes imperative to acknowledge the varied costs, impacts on vehicle lifespan, and comfort levels associated with such diverse terrains. This discussion sheds light on a conspicuous research gap pertaining to the development of vehicles specifically tailored for rural and district roads in India. Given that India boasts the world's second-largest road network 6.2 million km, surpassing most nations and trailing only the United States network of 6.8 millions, addressing this research gap holds considerable significance.

- ***Challenges on Rural Roads:*** High-speed vehicles traversing rural roads face challenges that are markedly different from those on well-maintained highways or expressways. These challenges can manifest in increased wear and tear, reduced vehicle lifespan, and a compromise in passenger comfort. The uneven terrain, varying road conditions, and limited infrastructure on rural roads necessitate a nuanced understanding of the unique demands placed on vehicles operating in such environments.
- ***Economic Considerations:*** One key aspect that warrants thorough investigation is the economic impact of operating high-speed vehicles on rural roads. The costs associated with maintenance, repairs, and the overall lifecycle of a vehicle can differ significantly in comparison to vehicles predominantly used on smoother surfaces. Exploring these economic considerations is crucial for developing cost-effective solutions and optimizing the financial aspects of vehicle ownership and operation in rural areas.
- ***Vehicle Durability:*** The longevity of vehicles operating on rural roads is a critical factor that requires in-depth exploration. The wear and tear experienced by components such as suspension systems, tyres, and the chassis can be accelerated in challenging terrains. Research efforts need to focus on enhancing the durability of vehicles, possibly through innovative engineering solutions or the use of advanced materials, to mitigate the adverse effects of prolonged exposure to rural road conditions.

- ***Passenger Comfort:*** Beyond the mechanical aspects, the comfort of passengers is a paramount concern when designing vehicles for rural roads. Understanding the unique dynamics of these terrains is essential for implementing features that ensure a smoother and more comfortable ride. This includes innovations in suspension systems, seat design, and overall vehicle ergonomics to address the challenges posed by uneven surfaces and road irregularities.
- ***Significance of Research in India:*** Given that India possesses the world's second-largest road network, the outcomes of this research can have far-reaching implications. Tailoring vehicles to suit the demands of rural and district roads is not only economically prudent but also aligns with India's commitment to improving accessibility and connectivity in remote areas. The findings of this research can potentially contribute to the development of a robust transportation infrastructure that caters to the diverse needs of the country's vast and varied landscape.

In the light of above considerations, the development of vehicles customized for rural and district roads in India is a crucial undertaking. The unique challenges posed by rural terrains necessitate a focused exploration of economic considerations, vehicle durability, and passenger comfort. The outcomes of such research can pave the way for the design and implementations of vehicles that are not only resilient to the demands of rural roads but also contribute to the overall improvement of India's extensive road network. This research holds the potential to shape the future of transportation in India, ensuring that it is not only efficient but also tailored to the specific needs of the diverse landscapes it encompasses.

6.1 ANALYSIS AND DESIGN OF LIGHT VEHICLES FOR RURAL ROADS CONSIDERING VIBRATION GENERATED WITH BUMPS UP TO 150MM AND ITS PERFORMANCE

As of March 31, 2020, India possesses the world's second-largest road network, spanning 62,15,797 km, trailing only the United States with 68,53,024 km. The country has constructed 1,38,531 km of National Highways and Expressways, 1,76,818 km of State Highways, contributing to a total length of 3,15,349 km. Remarkably, approximately 50% of this extensive road network is situated in rural areas, consisting of surfaces not fortified with cement pavement or bituminous materials of requisite strength. Despite lacking these enhancements, these rural roads play a pivotal role in the transportation of the rural population. The prevalence of uneven surfaces, potholes, and damaged road sections leads to significant discomfort, stress, and fatigue for both passengers and drivers of light vehicles, such as transport carriers, passenger cars, or jeeps.

This investigation focuses on the vibrations experienced by light vehicles traversing rural road geometries. The impact of bumps, potholes, and irregularities on the lifespan

of such vehicles is explored. A mathematical model, incorporating higher degrees of freedom, is formulated and simulated using Matlab/Simulink software. Independent and dependent parametric variables, including bumps, pitching, bounce, suspension, tyre stiffness coefficient, and damping, are considered. The simulation encompasses a range of bump heights (0.025 m, 0.050 m, 0.075 m, 0.100 m, 0.125 m, and 0.150 m) and vehicle speeds ranging from 25 km/h to 125 km/h. The results indicate that optimal vehicle performance and comfort are achieved at speeds exceeding 65 km/h under challenging rural road conditions in India. The study emphasizes the significance of incorporating appropriate tyre stiffness coefficients, suspension systems, damping devices, and managing sprung and unsprung masses when designing a car model with seven degrees of freedom.

Extensive literature reviews on the work of various researchers in this domain were undertaken, revealing the formulation of mathematical models for light vehicles using non-linear equations, linear quadratic regulator methods, algorithms, and simulation tools such as Matlab, 20sim, Adams, Bond graph, 20sim mechanism, or fuzzy control.

The core of this study revolves around mitigating vibrations in a full car with seven degrees of freedom using Matlab/Simulink. A mathematical model is constructed, considering bouncing, pitching, and rolling conditions, incorporating an active suspension system. Results obtained through simulation suggest the potential development of a light and robust car on a cost-effective model. This alternative proposes a durable vehicle suitable for traversing inconvenient, uneven, pothole-ridden, and damaged rural roads, enhancing performance, longevity, and economic feasibility. Such initiatives have the potential to stimulate the country's economy while contributing to energy conservation and reducing carbon footprints.

Development of Vehicle Model

Dynamic Model: The full car model develops linear equation of mass, spring and damper with seven degree of freedom suspension for comfort ride.

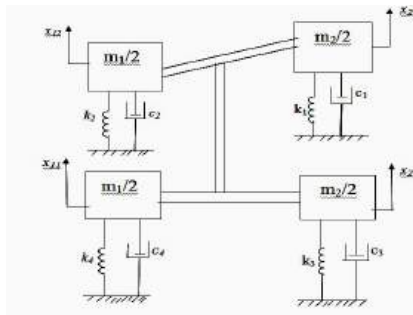

Fig 6.1 Dynamic model

To examine and optimize the vibration of a vehicle, full car vibrating model must be used. Full car model can be seen in **Fig. 6.1** Full car dynamic model. This model includes the body bounce the full car model may be different for the front and rear

suspension and mass distribution, unsprung mass are $m_2/2$, $m_1/2$, $m_1/2$ and $m_2/2$ respectively, damping coefficient are c_1 , c_2 , c_3 and c_4 respectively, stiffness are k_1 , k_2 , k_3 and k_4 are respectively, displacement are x_{21}, x_{12}, x_{11} x_{22} .

Using differential and law of motion authors develop the following linear equation. Equations of motions of unsprung mass are given as:

$$\frac{m_2}{2}x_{21} + k_1(x_{21} - x_{12}) + c_1(x_{21} - x_{12}) = 0 \quad (6.1)$$

$$\frac{m_1}{2}x_{12} - k_1(x_{21} - x_{12}) - c_1(x_{21} - x_{12}) + k_2x_{12} + c_2x_{12} = 0 \quad (6.2)$$

$$\frac{m_1}{2}x_{11} + k_4x_{11} + c_4x_{11} = 0 \quad (6.3)$$

$$\frac{m_1}{2}x_{11} + k_4x_{11} + c_4x_{11} = 0 \quad (6.4)$$

When we consider stiffness and damping coefficient are equal $k_1=k_3$ and $c_1=c_3$

Applying in equation (6.3), we get

$$\frac{m_2}{2}x_{22} + k_1x_{22} + c_1x_{22} = 0 \quad (6.5)$$

Applying Equation (6.5) into Equation (6.1) if both are equal

$$\begin{aligned} \frac{m_2}{2}x_{21} + k_1(x_{21} - x_{12}) + c_1(x_{21} - x_{12}) &= \frac{m_2}{2}x_{22} + k_1x_{22} + c_1x_{22} \\ \frac{m_2}{2}(x_{21} - x_{22}) + k_1(x_{21} - x_{12} - x_{22}) + c_1(x_{21} - x_{12} - x_{22}) &= 0 \end{aligned} \quad (6.6)$$

Similarly we consider stiffness and damping coefficient are equal $k_2=k_4$ and $c_2=c_4$

Applying in equation (6.4), we get;

$$\frac{m_1}{2}x_{11} + k_2x_{11} + c_2x_{11} = 0 \quad (6.7)$$

Applying equation (6.7) into equation (6.2) if both are equal

$$\begin{aligned} \frac{m_1}{2}x_{12} - k_1(x_{21} - x_{12}) - c_1(x_{21} - x_{12}) + k_2x_{12} + c_2x_{12} &= \frac{m_1}{2}x_{11} + c_2x_{11} + k_2x_{11} \\ \frac{m_1}{2}(x_{11} - x_{12}) + k_1(x_{21} - x_{12}) + c_1(x_{21} - x_{12}) + k_2(x_{11} - x_{12}) + c_2(x_{11} - x_{12}) &= 0 \end{aligned} \quad (6.8)$$

Consider displacement, stiffness, damping coefficient are equal

$$x_{21} = x_{22}, k_1=k_3, c_1=c_3, c_2=c_4, k_2=k_4$$

Putting equation (6.6) and (6.8) we get;

From equation (6.6)

$$\frac{m_2}{2}(x_{21} - x_{22}) + k_1(x_{21} - x_{12} - x_{22}) + c_1(x_{21} - x_{12} - x_{22}) = 0$$

$$\frac{m_2}{2}(x_{21} - x_{22}) + k_1(x_{21} - x_{12} - x_{21}) + c_1(x_{21} - x_{12} - x_{22}) = 0$$

$$\frac{m_2}{2}(x_{21} - x_{22}) - k_1 x_{12} + c_1(x_{21} - x_{12} - x_{22}) = 0 \quad (6.9)$$

From equation (6.8)

$$\frac{m_1}{2}(x_{11} - x_{12}) + k_3(x_{22} - x_{12}) + c_3(x_{21} - x_{12}) + k_4(x_{11} - x_{12}) + c_4(x_{11} - x_{12}) = 0$$

$$\frac{m_1}{2}(x_{11} - x_{12}) + k_1(x_{21} - x_{12}) + c_1(x_{21} - x_{12}) + k_2(x_{11} - x_{12}) + c_2(x_{11} - x_{12}) = 0 \quad (6.10)$$

We consider velocity, stiffness; damping coefficient and displacement are equal

$$x_{21} = x_{22}, k_1 = k_3, c_1 = c_3, c_2 = c_4, k_2 = k_4, x_{21} = x_{22}$$

Putting in equation (7.9) and (7.10) we get;

From equation (6.9)

$$\frac{m_2}{2}(x_{21} - x_{22}) - k_1 x_{12} + c_1(x_{21} - x_{12} - x_{22}) = 0$$

$$\frac{m_2}{2}(x_{21} - x_{22}) - k_1 x_{12} + c_1(x_{21} - x_{12} - x_{21}) = 0 \quad (6.11)$$

From equation (6.10)

$$\frac{m_1}{2}(x_{11} - x_{12}) + k_3(x_{22} - x_{12}) + c_3(x_{21} - x_{12}) + k_4(x_{11} - x_{12}) + c_4(x_{11} - x_{12}) = 0$$

$$\frac{m_1}{2}(x_{11} - x_{12}) + k_1(x_{22} - x_{12}) + c_1(x_{21} - x_{12}) + k_2(x_{11} - x_{12}) + c_2(x_{11} - x_{12}) = 0 \quad (6.12)$$

Dynamic Model with Pitching

To excellent examine and optimize the full car model with pitching vibration of a vehicle, Full car vibrating model must be used. This model includes the body bounce and body roll. The full car model may be different for the front and rear full car due to different suspension and mass distribution. Sprung mass is m , sprung mass displacement are z_1, z_2, z_3 and z_4 respectively, rolling in x direction pitching in y direction and bouncing in z direction respectively, unsprung mass are $m_2/2, m_1/2, m_1/2$ and $m_2/2$ respectively, damping coefficient are c_1, c_2, c_3 and c_4 respectively, stiffness are k_1, k_2, k_3 and k_4 are respectively, displacement are $x_{21}, x_{12}, x_{11}, x_{22}$. However, vibration model of vehicle must be expanded for including pitch and other modes of vibrations a and b are distance from mass centre to front and rear axle full car model

includes body bounce and body pitch Full car model with pitching can be seen in **Fig. 6.2**

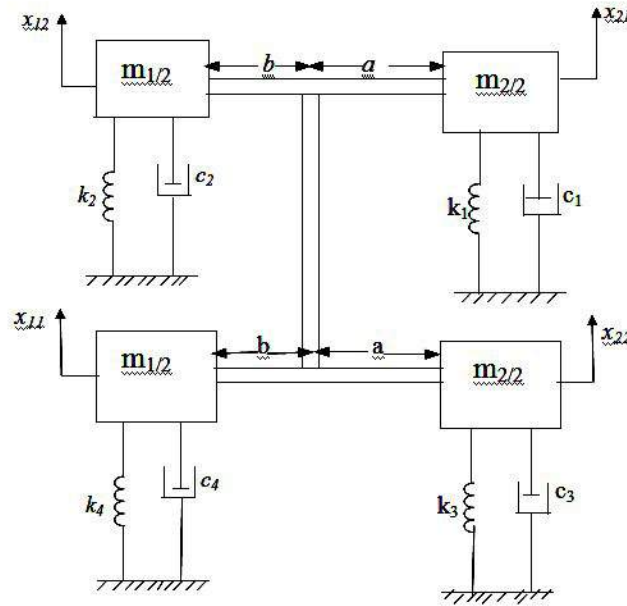

Fig.6.2: Dynamic model with pitching

Using Newton's second law, the dynamic equation of bouncing are given as

$$mz - c_1(z_1 - x_{12}) - k_1(z_1 - x_{21}) - c_2(z_2 - x_{12}) - k_2(z_2 - x_{12}) - c_3(z_3 - x_{22}) - k_3(z_3 - x_{22}) - c_4(z_4 - x_{11}) - k_4(z_4 - x_{11}) = 0 \quad (6.13)$$

Using Newtons second law, the dynamic equation of pitching are as

$$I\theta - bk_2(x_{12} - b\theta) - bc_2(x_{12} - b\theta) - bk_4(x_{11} - b\theta) - bc_4(x_{11} - b\theta) + ak_1(x_{21} - a\theta) + ac_1(x_{21} - a\theta) + ak_3(x_{22} - a\theta) + ac_3(x_{22} - a\theta) = 0 \quad (6.14)$$

Using Newtons second law , the dynamic equation of rolling are given as

$$I\varphi + bk_2(x_{12} - b\varphi) + bc_2(x_{12} - b\varphi) + bk_4(x_{11} - b\varphi) + bc_4(x_{11} - b\varphi) - ak_1(x_{21} - a\varphi) - ac_1(x_{21} - a\varphi) - ak_3(x_{22} - a\varphi) - ac_3(x_{22} - a\varphi) = 0 \quad (6.15)$$

Simulink Model

Simulink model for the same road excitation: System needs to simulate the entire suspension system derive from equation 6.1 to equation 6.15 respectively for sprung mass, unsprung mass , unsprung wheel, pitching, rolling and bouncing. The mathematical model of 4-wheeled vehicle with driver seated on cushion seat is simulated with Simulink Software.

Table-6.1: Parameter of full car model

Symbol	Parameter Description	Value
m_s	Mass of the sprung mass	1300 kg
m_{uf}	Front mass of the wheel or unsprung mass	65 kg
m_{ur}	Rear mass of the wheel or unsprung mass	60 kg
I_p	Pitch moment of inertia	2391.08 kgm ²
I_r	Roll moment of inertia	391.08 kg m ²
k_f	Stiffness of vehicle for front	36300 N/m
k_r	Stiffness of vehicle for rear	19600 N/m
c_f	Front damping coefficient	4000 kNs/m
c_r	Rear damping coefficient	3000 kNs/m
a	Distance from centre of sprung mass to front wheel	1.6 m
b	Distance from centre of sprung mass to rear wheel	0.9 m

Simulation

Simulation results are presented in this paper. Results are also presenting in summarized and graphical form in **Table-6.1** is obtained after simulating the development model. The different figures in the simulated results obtained at various speeds are 25 km/h to 125 km/h taken for simulation of parameter analyzed suspension displacement. I have found representation of simulation result presented easier to review and read. It is clear to understand with logical order through Simulink. Bump height 0.025 m, 0.050 m, 0.075 m, 0.100 m, 0.125 m and 0.150 m taken for different vibration in a different time interval in real simulation for comfort ride.

Simulation results at Bump height 0.025 m and at different speeds of 25 km/h, 50 km/hr, 75 km/hr, 100 km/hr and 125 km/hr are shown below

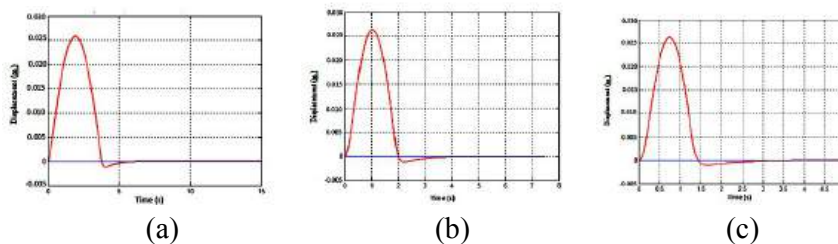

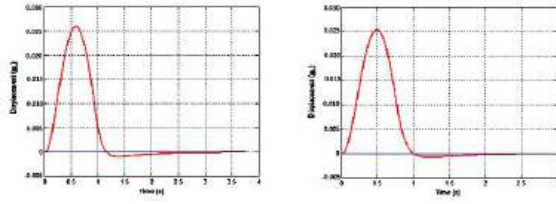

(d) (e)

Fig 6.3: Sprung-Mass Displacement vs. Time at Bump height 0.025 m and a speed of (a) 25 km/h, (b) 50 km/h, (c) 75 km/h, (d) 100 km/h, and (e) 125 km/h.

Simulation results at Bump height 0.050 m and at different speeds of 25 km/h, 50 km/hr, 75 km/hr, 100 km/hr and 125 km/hr are shown below

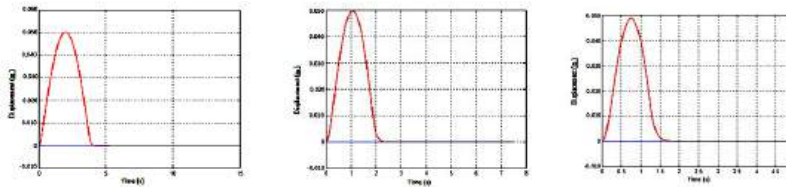

(a) (b) (c)

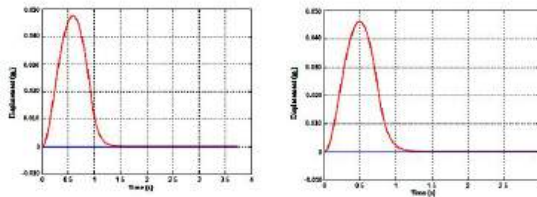

(d) (e)

Fig 6.4: Sprung-Mass Displacement vs. Time at Bump height 0.050 m and a speed of (a) 25 km/h, (b) 50 km/h, (c) 75 km/h, (d) 100 km/h, and (e) 125 km/h.

Simulation results at Bump height 0.075 m and at different speeds of 25 km/h, 50 km/hr, 75 km/hr, 100 km/hr and 125 km/hr are shown below

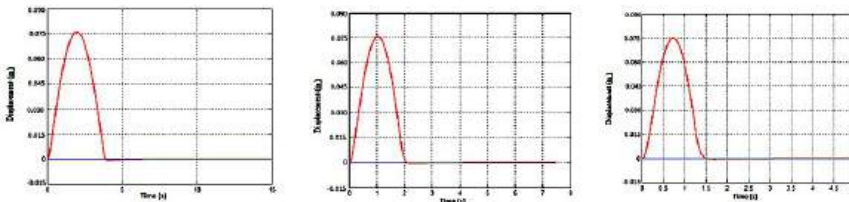

(a) (b) (c)

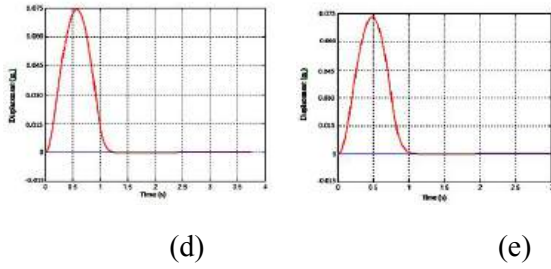

Fig 6.5: Sprung-Mass Displacement vs. Time at Bump height 0.075 m and a speed of (a) 25 km/h, (b) 50 km/h, (c) 75 km/h, (d) 100 km/h, and (e) 125 km/h.

Simulation results at Bump height 0.100 m and at different speeds of 25 km/h, 50 km/hr, 75 km/hr, 100 km/hr and 125 km/hr are shown below

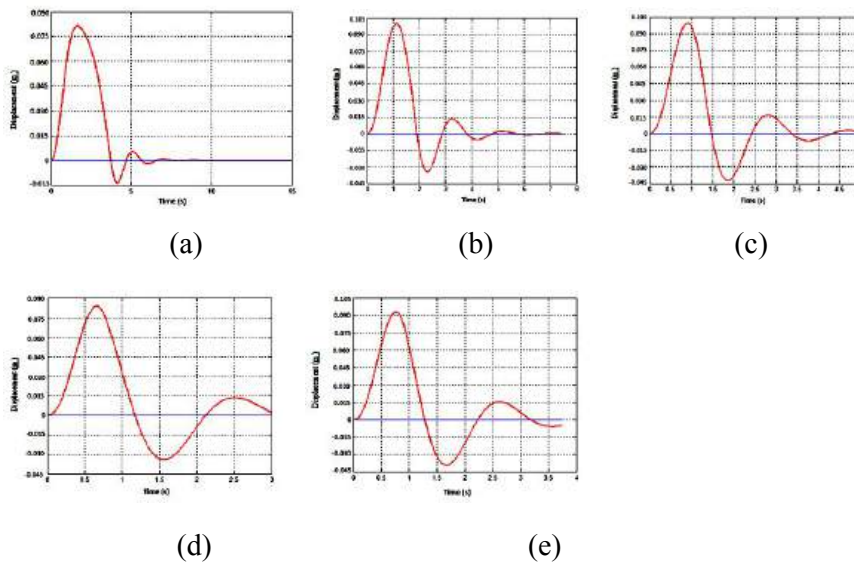
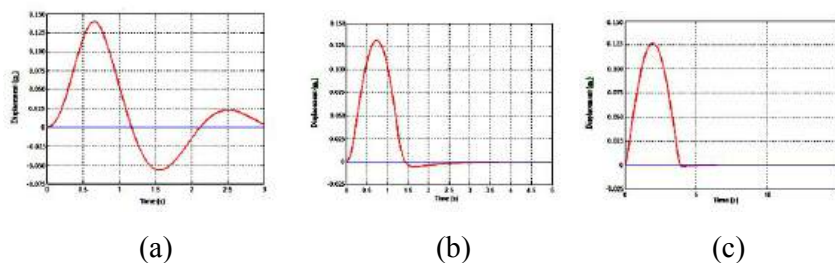

Fig 6.6: Sprung-Mass Displacement vs. Time at Bump height 0.100 m and a speed of (a) 25 km/h, (b) 50 km/h, (c) 75 km/h, (d) 100 km/h, and (e) 125 km/h.

Simulation results at Bump height 0.125 m and at different speeds of 25 km/h, 50 km/hr, 75 km/hr, 100 km/hr and 125 km/hr are shown below:



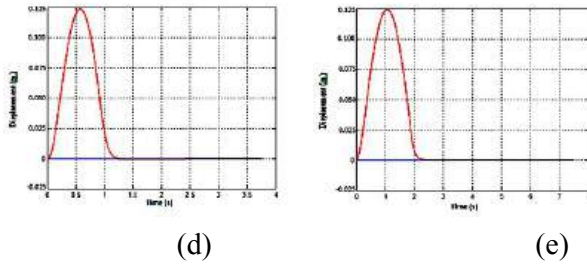

Fig 6.7: Sprung-Mass Displacement vs. Time at Bump height 0.125 m and a speed of (a) 25 km/h, (b) 50 km/h, (c) 75 km/h, (d) 100 km/h, and (e) 125 km/h.

Simulation results at Bump height 0.150 m and at different speeds of 25 km/h, 50 km/hr, 75 km/hr, 100 km/hr and 125 km/hr are shown below:

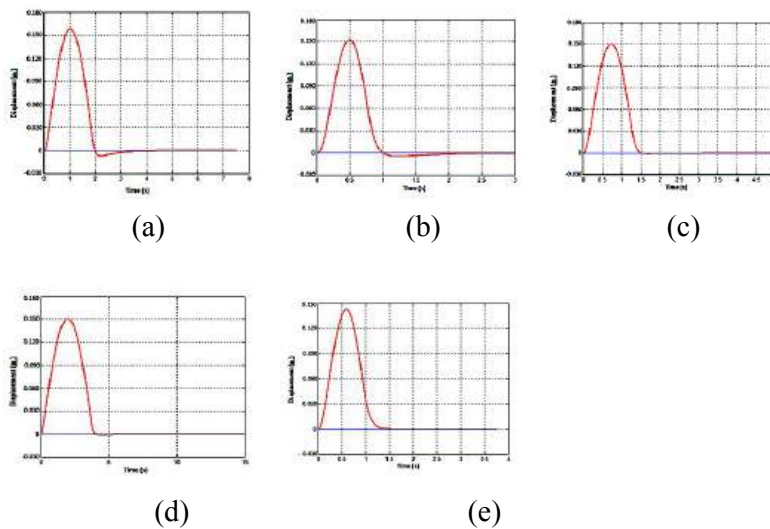

Fig. 6.8: Sprung-Mass Displacement vs. Time at Bump height 0.150 m and a speed of (a) 25 km/h, (b) 50 km/h, (c) 75 km/h, (d) 100 km/h, and (e) 125 km/h.

6.2 ANALYSIS AND DESIGN FOR COMFORT RIDE OF 4-WHEELED VEHICLES VIBRATION ON RURAL ROAD SURFACE CONSIDERING TYRE COEFFICIENT AND TO REDUCE CLIMATE IMPACT

In this research, novel data is meticulously organized to provide a systematic presentation. Specifically, we examine the impact of damping coefficient values of up to 8 kN/m on vehicle vibrations. Notably, we observe that the highest displacement of the sprung mass improves up to a vehicle speed of 62.5 km/h. However, beyond this speed threshold and up to 125 km/h, the displacement starts to decrease. This insight is crucial for understanding the dynamics of vehicle vibration and its relationship with speed, which is essential for optimizing ride comfort.

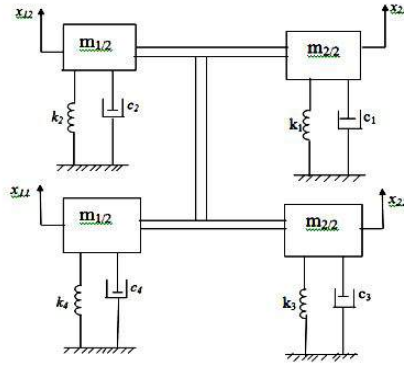

Fig. 6.9: Four wheeled car model when front and rear load are equal

The central focus of this study is to leverage Simulink/Symbolshakti simulation technology for modeling vehicles and simulating diverse response characteristics. The simulation aims to explore alternative vehicle models with the goal of enhancing comfort during rides, particularly at higher speeds, even surpassing 30 km/h, especially on uneven road conditions. The findings indicate that by strategically replacing higher bumps with ramble strips and maintaining an optimal distance for pitching, along with suitable spring stiffness and damper constants, the comfort of rides at higher speeds can be significantly improved. This innovative approach offers practical insights for designing vehicles that prioritize comfort, especially when traversing challenging road conditions.

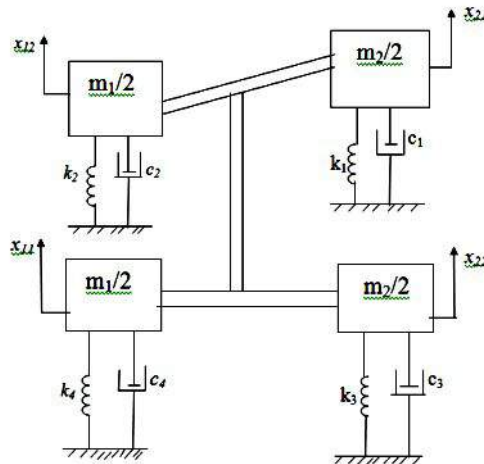

Fig. 6.10: Four wheeled car model having different load

Development of a Vehicle Representation

The development of a vehicle representation of sprung mass is complimentary in the direction of heave roll and pitch. They are complementary to rebound perpendicularly through the sprung mass and it directly converts inside

Symbolshakti. m_s is sprung mass, m_{uf} is unsprung mass of front wheel, m_{ur} is unsprung mass of rear wheel, I_p is moment of inertia of pitching, I_r is moment of inertia of rolling, Z_s displacement of vehicle representation, Z_{s1} , Z_{s2} , Z_{s3} and Z_{s4} are displacement of vehicle representation for each corner, Z_{u1} , Z_{u2} , Z_{u3} and Z_{u4} displacement of wheel respectively, T_f is front treat, T_r is rear treat, a is distance from centre of sprung mass to front wheel, b is distance from centre of sprung mass to rear wheel, bf is front tyre damping coefficient, br is rear tyre damping coefficient, k_f is stiffness of vehicle representation spring for front, k_r is stiffness of Vehicle representation spring for rear, k_{fj} is front stiffness tyre, k_{tr} is rear stiffness tyre. Development of a vehicle representation suspension is established shown in **Fig.6.11** and their parameter is shown in **Table 6.2**.

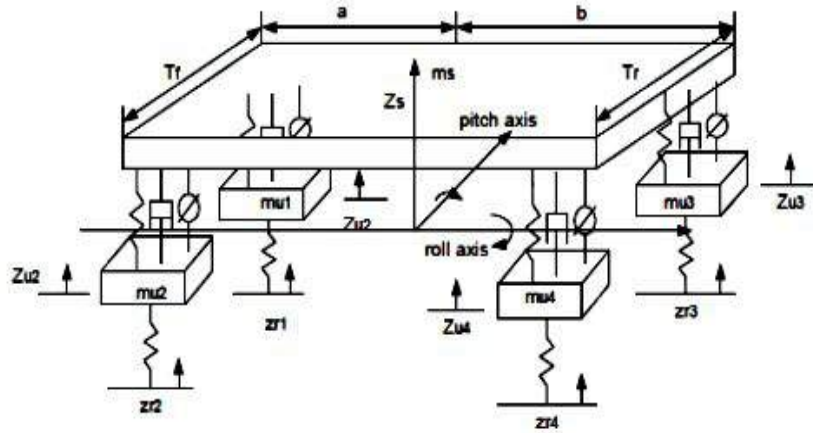

Fig.6.11: Vehicle Representation

Mathematical Model a Vehicle Representation

The mathematical equation of a vehicle representative of the unsprung and sprung masses is given below:

a) For rolling motion

$$\begin{aligned}
 I_r \ddot{\phi}_s = & -b_f T_f (Z_{s1} - Z_{u1}) + b_f T_f (Z_{s2} - Z_{u2}) - b_r T_r (Z_{s3} - Z_{u3}) \\
 & + b_r T_r (Z_{s4} - Z_{u4}) - k_f T_f (Z_{s1} - Z_{u1}) + k_f T_f (Z_{s2} - Z_{u2}) \\
 & - k_r T_r (Z_{s3} - Z_{u3}) + k_r T_r (Z_{s4} - Z_{u4})
 \end{aligned} \tag{6.16}$$

b). For pitching motion

$$\begin{aligned}
 I_p \ddot{\theta}_s = & -b_f (Z_{s1} - Z_{u1}) - b_f a (Z_{s2} - Z_{u2}) + b_r b (Z_{s3} - Z_{u3}) \\
 & + b_r b (Z_{s4} - Z_{u4}) - k_f a (Z_{s1} - Z_{u1}) - k_f a (Z_{s2} - Z_{u2}) \\
 & + k_r b (Z_{s3} - Z_{u3}) + k_r b (Z_{s4} - Z_{u4})
 \end{aligned} \tag{6.17}$$

c). For bouncing

$$\begin{aligned}
 m_s \ddot{Z}_s &= -b_f(Z_{s1} - Z_{u1}) - b_f(Z_{s2} - Z_{u2}) - b_r(Z_{s3} - Z_{u3}) \\
 &- b_r(Z_{s4} - Z_{u4}) - k_f(Z_{s1} - Z_{u1}) - k_f(Z_{s2} - Z_{u2}) \\
 &- k_r(Z_{s3} - Z_{u3}) - k_r(Z_{s4} - Z_{u4})
 \end{aligned} \tag{6.18}$$

d). Every sides of wheel motion

$$m_{uf} \ddot{Z}_{u1} = b_f(Z_{s1} - Z_{u1}) + k_f(Z_{s1} - Z_{u1}) - k_{yf} Z_{u1} + k_{yf} Z_{r1} \tag{6.19}$$

$$m_{ur} \ddot{Z}_{u2} = b_f(Z_{s2} - Z_{u2}) + k_f(Z_{s2} - Z_{u2}) - k_{yf} Z_{u2} + k_{yf} Z_{r2} \tag{6.20}$$

$$m_{ur} \ddot{Z}_{u3} = b_r(Z_{s3} - Z_{u3}) + k_r(Z_{s3} - Z_{u3}) - k_{yr} Z_{u3} + k_{yr} Z_{r3} \tag{6.21}$$

$$m_{ur} \ddot{Z}_{u4} = b_r(Z_{s4} - Z_{u4}) + k_r(Z_{s4} - Z_{u4}) - k_{yr} Z_{u4} + k_{yr} Z_{r4} \tag{6.22}$$

Table 6.2: Parameters considered for 4-Wheeled vehicle representation

SNo.	Description	Notations	Value	Units
1.	Sprung Mass of the vehicle	m_s	1125	kg
2.	Unsprung mass of front wheel	m_{uf}	65	kg
3.	Unsprung mass of rear wheel	m_{ur}	69	kg
4.	Moment of Inertia of pitching	I_p	2500	kgm ²
5.	Moment of Inertia of rolling	I_r	500	kgm ²
6.	Stiffness of vehicle at front axle	k_f	36,000	N/m
7.	Stiffness of vehicle at rear axle	k_r	20,000	N/m
8.	Front treat	T_f	0.505	m
9.	Rear treat	T_r	0.557	m
10.	Front tyre stiffness	k_{yf}	182500	N/m
11.	Rear tyre stiffness	k_{yr}	182500	N/m
12.	Front tyre coefficient	b_f	8 & 16	kNs/m
13.	Rear tyre coefficient	b_r	4 & 12	kNs/m
14.	Distance from centre of sprung mass to front wheel	a	1.15	m
15.	Distance from centre of sprung mass to rear wheel	b	1.65	m

Vehicle Representation Simulation

Simulation results are presented in this paper. Results are also presenting in summarized and graphical form in **Table 6.2** is obtained after simulating the development model.

The different figures in the simulated results obtained at various speeds are 25 km/h to 125 km/h taken for simulation of parameter analyzed suspension displacement. The simulation results are presented easier to read and review and found to understand with logical order through Simulink.

Simulations Result

Considering the sprung-mass, un-sprung mass, **tyre damping coefficients** at different bumps and speeds from 25 km/h, 50km/hr, 75km/hr, 100km/hr and 125 km/h) etc. for:

- **First stage;** rear tyre (b_r) 4 kNs/m and front tyre (b_f) 8 kNs/m
- **Second stage;** rear tyre (b_r) 12 kNs/m, and front tyre (b_f) 16 kNs/m,

These simulation results are shown in the form of graphs as under:

Evaluation of Time Lags for Achieving Comfort Zones at Various Speeds (25 km/h, 50 km/h, 75 km/h, 100 km/h, and 125 km/h) with a Fixed Rear Tyre Damping Coefficient (b_r) of 4 kNs/m, Illustrated in Figs. 6.12 to 6.16.

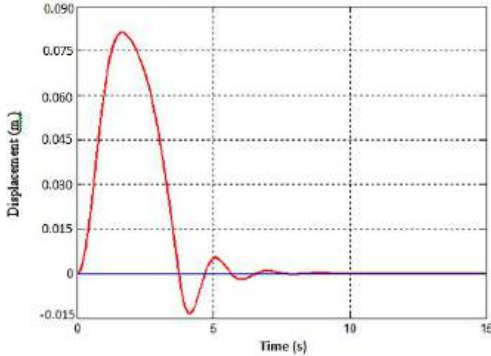

Fig. 6.12: Sprung-mass displacement vs. Time lag for comfort zone, when rear tyre damping coefficient (b_r) = 4 kNs/m and speed = 25 km/h.

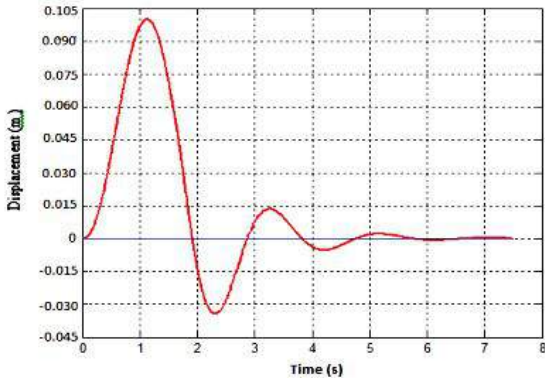

Fig. 6.13: Sprung-mass displacement vs. Time lag for comfort zone, when rear tyre damping coefficient (b_r) = 4 kNs/m and speed = 50 km/h

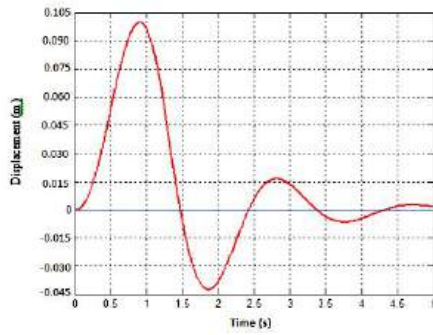

Fig.6.14: Sprung-mass displacement vs. Time lag for comfort zone, when rear *tyre damping coefficient* (b_r) = 4 kNs/m and speed = 75 km/h.

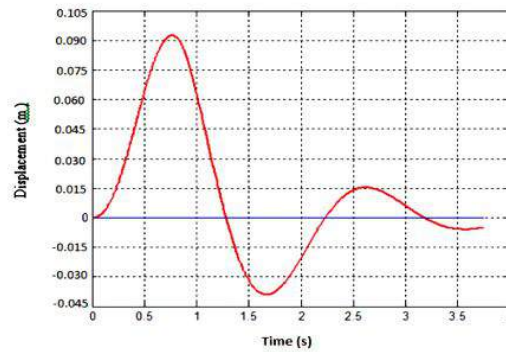

Fig. 6.15: Sprung-mass displacement vs. Time lag for comfort zone, when rear *tyre damping coefficient* (b_r) = 4 kNs/m and speed = 100 km/h.

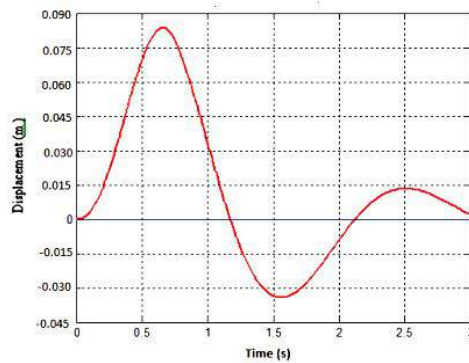

Fig. 6.16: Sprung-mass displacement vs. Time lag for comfort zone, when rear *tyre damping coefficient* (b_r) = 4 kNs/m and speed = 125 km/h.

Evaluation of Time Lags for Achieving Comfort Zones at Various Speeds (25 km/h, 50 km/h, 75 km/h, 100 km/h, and 125 km/h) with a Fixed front Tyre Damping Coefficient (b_f) of 8 kNs/m, Illustrated in Figs.6.17 to 6.21

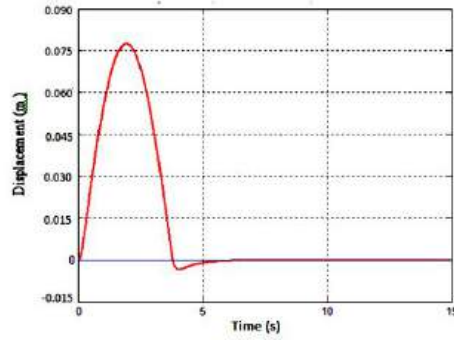

Fig. 6.17: Sprung-mass displacement vs. Time lag for comfort zone, when front tyre damping coefficient (b_f) = 8 kNs/m and Speed = 25 km/h.

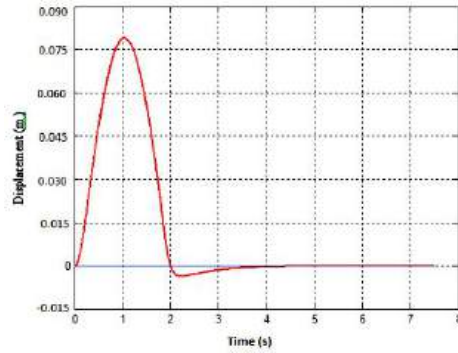

Fig. 6.18: Sprung-mass displacement vs. Time lag for comfort zone, when front tyre damping coefficient (b_f) = 8 kNs/m and speed = 50 km/h.

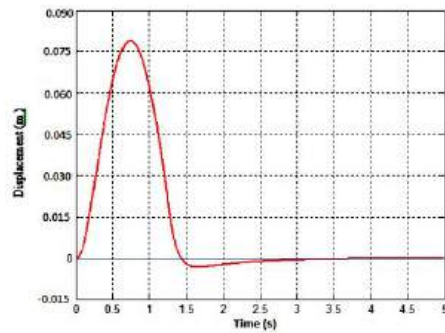

Fig. 6.19: Sprung-mass displacement vs. Time lag for comfort zone, when front tyre damping coefficient (b_f) = 8 kNs/m and speed = 75 km/h

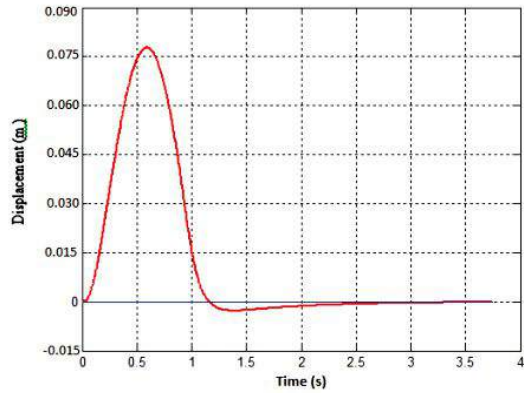

Fig. 6.20: Sprung-mass displacement vs. Time lag for comfort zone, when *front tyre damping coefficient* (b_f) = 8 kNs/m and speed = 100 km/h.

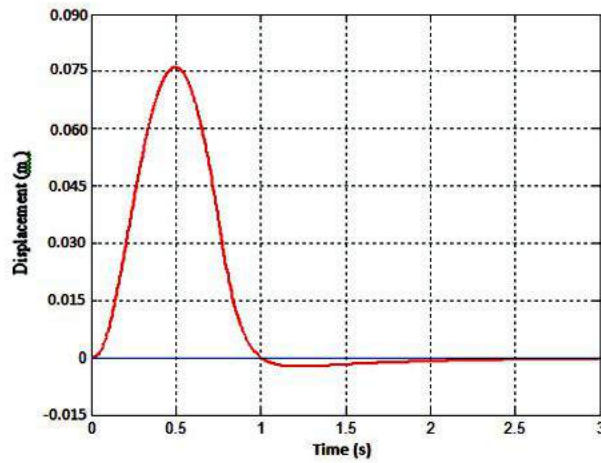

Fig. 6.21: Sprung-mass displacement vs. Time lag for comfort zone, when *front tyre damping coefficient* (b_f) = 8 kNs/m and speed = 125 km/h.

Evaluation of Time Lags for Achieving Comfort Zones at Various Speeds (25 km/h, 50 km/h, 75 km/h, 100 km/h, and 125 km/h) with a Fixed Rear Tyre Damping Coefficient (b_r) of 12 kNs/m, Illustrated in Figs. 6.22 to Fig.6.26.

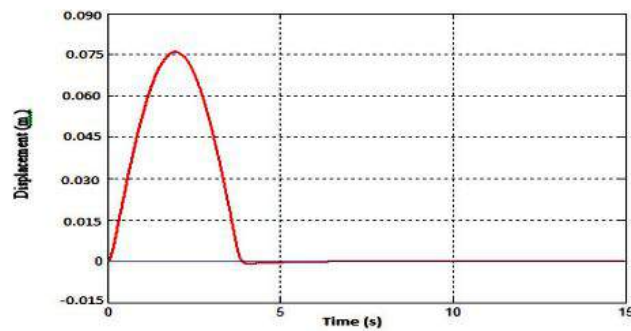

Fig. 6.22: Sprung-mass displacement vs. Time lag for comfort zone, when *rear tyre damping coefficient* (b_r) = 12 kNs/m and speed = 25 km/h.

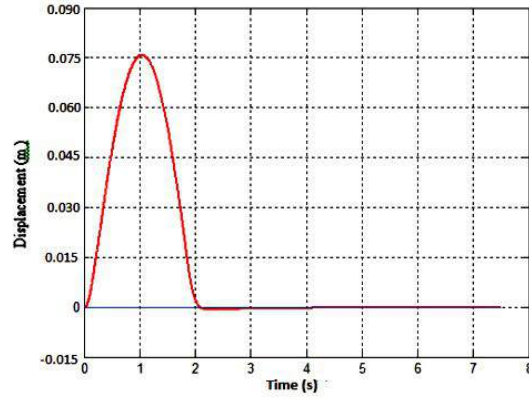

Fig. 6.23: Sprung-mass displacement vs. Time lag for comfort zone, when *rear tyre damping coefficient* (b_r) = 12 kNs/m and speed = 50 km/h.

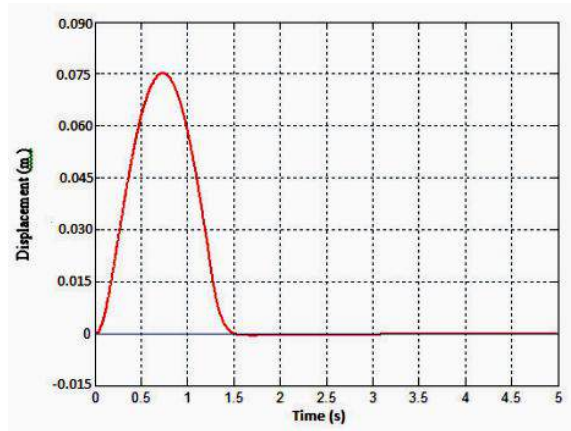

Fig. 6.24: Sprung-mass displacement vs. Time lag for comfort zone, when *rear tyre damping coefficient* (b_r) = 12 kNs/m and speed = 75 km/h

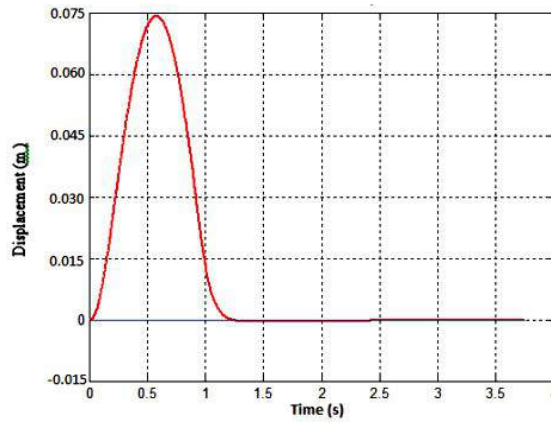

Fig. 6.25: Sprung-mass displacement vs. Time lag for comfort zone, when *rear tyre damping coefficient* (b_r) = 12 kNs/m and speed = 100 km/h.

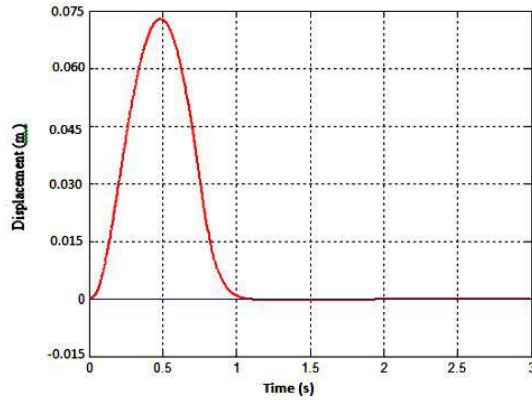

Fig. 6.26: Sprung-mass displacement vs. Time lag for comfort zone, when rear tyre damping coefficient (b_r) = 12 kNs/m and speed = 125 km/h.

Evaluation of Time Lags for Achieving Comfort Zones at Various Speeds (25 km/h, 50 km/h, 75 km/h, 100 km/h, and 125 km/h) with a Fixed Front Tyre Damping Coefficient (b_f) of 16 kNs/m, Illustrated in Fig.6.27 to Fig. 6.31

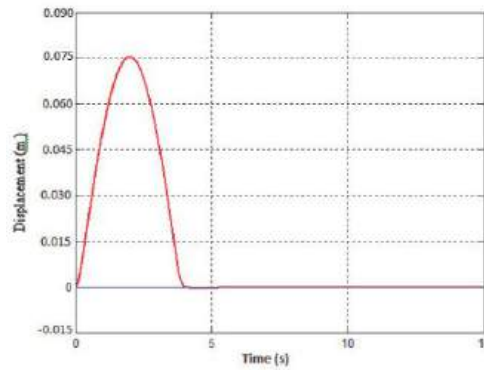

Fig. 6.27: Sprung-mass displacement vs. Time lag for comfort zone, when front tyre damping coefficient (b_f) = 16 kNs/m and speed = 25 km/h.

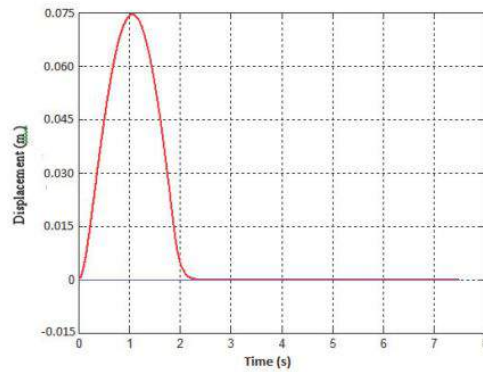

Fig. 6.28: Sprung-mass displacement vs. Time lag for comfort zone, when front tyre damping coefficient (b_f) = 16 kNs/m and speed = 50 km/h.

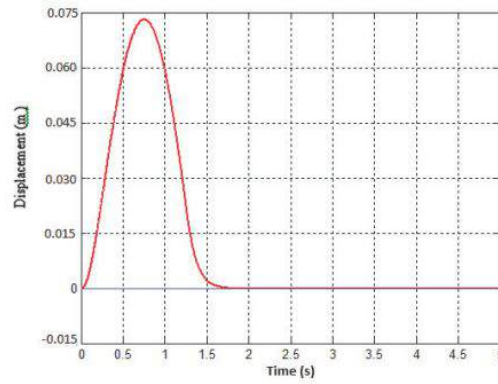

Fig. 6.29: Sprung-mass displacement vs. Time lag for comfort zone, when *front tyre damping coefficient*, $(b_f) = 16 \text{ kNs/m}$ and speed = 75 km/h.

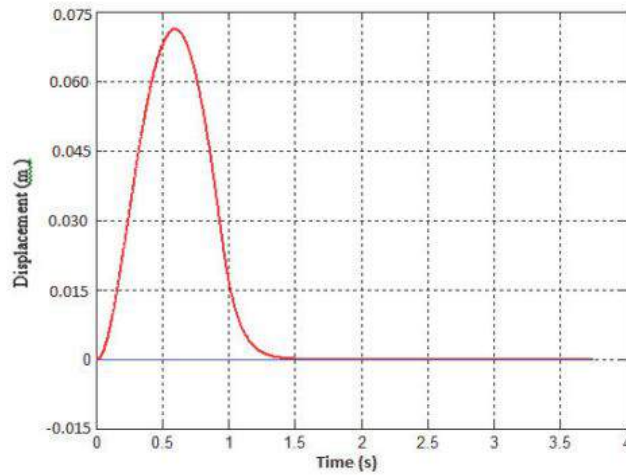

Fig. 6.30: Sprung-mass displacement vs. Time lag for comfort zone, when *front tyre damping coefficient*, $(b_f) = 16 \text{ kNs/m}$ and speed = 100 km/h.

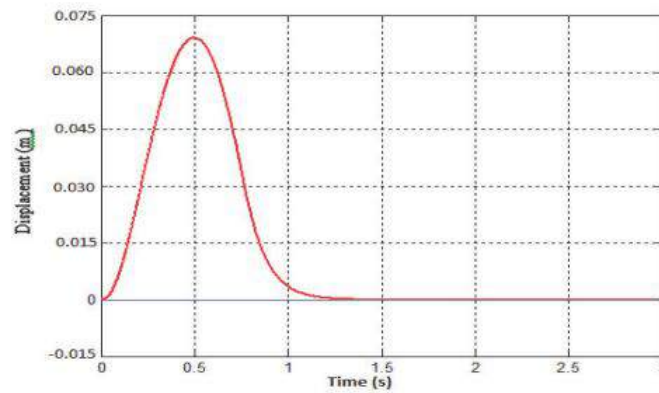

Fig. 6.31: Sprung-mass displacement vs. Time lag for comfort zone, when *front tyre damping coefficient*, $(b_f) = 16 \text{ kNs/m}$ and speed = 125 km/h

6.3 OUTCOME

Operating high-speed vehicles on rural roads poses unique challenges, particularly in terms of durability, comfort, and cost. Despite India's extensive rural road network, there is a significant research gap in designing vehicles specifically for these conditions.

To address this, research highlights the need for vehicles designed for rural roads with specific design criteria:

- Tyre damping coefficient: ≥ 4 kNs/m
- Speed capability: ≤ 75 km/h
- Suspension damping coefficient: ≤ 8 kNs/m for speeds between 50-75 km/h

This study is crucial in developing cost-effective, environmentally friendly vehicles tailored for rural roads, particularly in India.

CHAPTER 7

RESULTS AND DISCUSSION

7.1 ANALYSIS AND DESIGN OF LIGHT VEHICLES FOR RURAL ROADS CONSIDERING VIBRATION WITH BUMPS UP TO 150 MM AND ITS PERFORMANCE

Analysis and Findings of Simulated Graphs Shown in Figs. 6.3 (a) to 6.3(e)

At different speeds like: 25 km/hr, 50 km/hr, 75 km/hr, 100 km/hr and 125 km/hr when bump height is kept 0.025 m, maximum amplitudes of vibration and its die out of time periods are listed below in the **Table 7.1**.

Table 7.1: Displacement vs. Time at 0.025 m bump height at different Speeds of 25 km/hr, 50 km/hr, 75 km/hr, 100 km/hr and 125 km/hr

Bump height	Speed of Vehicle	Vibration amplitude	Time
0.025 m	25 km/hr	0.026 m	4 s
0.025 m	50 km/hr	0.027 m	2 s
0.025 m	75 km/hr	0.027 m	1.4 s
0.025 m	100 km/hr	0.026 m	1.1 s
0.025 m	125 km/hr	0.025 m	1 s

It is observed that at **bump height 0.025 m** vibration amplitudes are 0.026 m, 0.027 m, 0.027 m, 0.026 m and 0.025 m and its corresponding vibration die out time 4 sec, 2sec, 1.4 sec, 1.1 sec and 1.0 sec at vehicle speeds of 25 km/hr, 50 km/hr, 75 km/hr, 100 km/hr and 125 km/hr respectively. This indicates that at low vehicle speed vibration gets die out abruptly and time taken was found larger up to 4 seconds whereas at 125 km/hr speeds time taken is 1 sec only for the vehicle under examination for its comfort ride. This situation creates comfort ride at low speed.

Analysis and Findings of Simulated Graphs Shown in Figs. 6.4(a) to 6.4(e)

At different speeds like: 25 km/hr, 50 km/hr, 75 km/hr, 100 km/hr and 125 km/hr when bump height is kept 0.050 m, maximum amplitudes of vibration and its die out of time periods are listed below in the **Table 7.2**.

Table 7.2: Displacement vs. Time at 0.050 m bump height at different Speeds of 25 km/hr, 50 km/hr, 75 km/hr, 100 km/hr and 125 km/hr.

Bump height	Speed of Vehicle	Vibration amplitude	Time
0.050 m	25 km/hr	0.050 m	4 s
0.050 m	50 km/hr	0.050 m	2.2 s
0.050 m	75 km/hr	0.048 m	1.7 s
0.050 m	100 km/hr	0.047 m	1.5 s
0.050 m	125 km/hr	0.046 m	1.3 s

It is observed that at **bump height 0.050 m**, vibration amplitudes are 0.050 m, 0.050 m, 0.048 m, 0.047 m and 0.046 m and its corresponding vibration die out time 4 sec, 2.2sec, 1.7 sec, 1.5 sec and 1.3 sec at vehicle speeds of 25 km/hr, 50 km/hr, 75 km/hr, 100 km/hr and 125 km/hr respectively. This indicates that at low speed (i.e., 25 km /hr), vehicle vibration gets die out abruptly and time taken was found larger up to 4 seconds and at 125 km/hr vehicle vibration gets die out and time taken is found least up to 1.3 seconds for the vehicle under examination for its comfort ride. This situation creates comfort ride at low speed and at larger speeds discomfort for less time.

Analysis and Findings of Simulated Graphs Shown in Figs. 6.5 (a) to 6.5 (e) At different speeds like: 25 km/hr, 50 km/hr, 75 km/hr, 100 km/hr and 125 km/hr when bump height is kept 0.075 m, maximum amplitudes of vibration and its die out of time periods are listed below in the **Table 7.3**.

Table 7.3: Displacement vs. Time at 0.075 m bump height at different Speeds of 25 km/hr, 50 km/hr, 75 km/hr, 100 km/hr and 125 km/hr.

Bump height	Speed of Vehicle	Vibration amplitude	Time
0.075 m	25 km/hr	0.075 m	4 s
0.075 m	50 km/hr	0.075 m	2 s
0.075 m	75 km/hr	0.075 m	1.5 s
0.075 m	100 km/hr	0.074 m	1.2 s
0.075 m	125 km/hr	0.073 m	1 s

It is observed that at **bump height 0.075 m**, vibration amplitudes are 0.075 m, 0.075 m, 0.075 m, 0.074 m and 0.073 m and its corresponding vibration die out time 4 sec, 2 sec, 1.5 sec, 1.2 sec and 1 sec at vehicle speeds of 25 km/hr, 50 km/hr, 75 km/hr, 100 km/hr and 125 km/hr respectively. This indicates that at low speed (i.e., 25 km /hr), vehicle vibration gets die out abruptly and time taken was found larger up to 4 seconds and at 125 km/hr vehicle vibration gets die out and time taken is found least up to 1.0 seconds for the vehicle under examination for its comfort ride. This situation creates comfort ride at low speed and at larger speeds discomfort for less time.

Analysis and Findings of Simulated Graphs Shown in Figs.6.6 (a) to 6.6(e)

At different speeds like: 25 km/hr, 50 km/hr, 75 km/hr, 100 km/hr and 125 km/hr when bump height is kept 0.100 m, maximum amplitudes of vibration and die out of time periods are listed below in the **Table 7.4**.

It is observed that at **bump height 0.100 m**, vibration amplitudes are 0.080 m, 0.098 m, 0.097 m, 0.082 m and 0.097 m and its corresponding vibration die out time periods are found 3.9 sec, 1.9sec, 1.4 sec, 1.2 sec and 1.3sec at vehicle speeds of 25 km/hr, 50 km/hr, 75 km/hr, 100 km/hr and 125 km/hr respectively. This indicates that at low speed (i.e., 25 km /hr), vehicle vibration gets die out in harmonic motion and time taken was found larger up to 5.0 seconds, at 50 km/hr vibration also die out in harmonic motion with 4.5 seconds, and at 125 km/hr vehicle vibration gets die out in pulse and time taken was found least up to 1.3 second for the vehicle under examination for its comfort ride. This situation creates comfort ride at low speed and at larger speeds discomfort for less time.

Table 7.4: Displacement vs. Time at 0.100 m bump height at different Speeds of 25 km/hr, 50 km/hr, 75 km/hr, 100 km/hr and 125 km/hr

Bump height	Speed of Vehicle	Vibration amplitude	Time
0.100 m	25 km/hr	0.080 m	3.9 s
		-0.001 m	4.1 s
		0.003 m	5.0 s
0.100 m	50 km/hr	0.098 m	1.9 s
		-0.022m	2.3 s
		0.015m	3.2 s
		-0.002m	4.5 s
		0.000m	5.5 s
0.100 m	75 km/hr	0.097 m	1.4 s
0.100 m	100 km/hr	0.082 m	1.2 s
0.100 m	125 km/hr	0.092 m	1.3 s

Analysis and Findings of Simulated Graphs shown in Figs. 6.7(a) to 6.7(e)

At different speeds of the 25 km/hr, 50 km/hr, 75 km/hr, 100 km/hr and 125 km/hr at bump height 0.125 m; maximum amplitudes of vibration and die out of times are listed below in the **Table 7.5**.

It is observed that at **bump height 0.125 m**, vibration amplitudes are 0.137 m, 0.131 m, 0.126 m, 0.124 m and 0.125 m and its corresponding vibration die out time periods are found 1.2 sec, 1.4sec, 4.0sec, 1.3sec and 2sec at vehicle speeds of 25 km/hr, 50 km/hr, 75 km/hr, 100 km/hr and 125 km/hr respectively.

This indicates that at low speed (i.e., 25 km /hr), vehicle vibration gets die out in harmonic motion and time taken was found larger from 1.2 to 4.5 seconds and at 125

km/hr vehicle vibration gets die out in harmonic motion and time taken was found least up to 4.2 second for the vehicle under examination for its comfort ride.

Table 7.5: Displacement vs. Time at 0.125 m bump height at different Speeds of 25 km/hr, 50 km/hr, 75 km/hr, 100 km/hr and 125 km/hr

Bump height	Speed of Vehicle	Vibration amplitude	Time
0.125 m	25 km/hr	0.137 m,	1.2 s,
		0.55 m,	-0.55 s,
		0.025 m	2.5 sec
		0.000m	4.5sec
0.125 m	50 km/hr	0.131 m	1.4 s
		-0.016 m	1.6 s
		0.00 m	3.0 s
		0.001m	5.0 s
0.125 m	75 km/hr	0.126 m	4 s
		-0.040m	1.7 s
		0.015m	2.7 s
		-0.001m	3.7 s
0.125 m	100 km/hr	0.001m	5.5 s
		0.080 m	0.6 s
		-0.035m	1.6 s
		0.015m	2.5 s
0.125 m	125 km/hr	0.000m	3.6 s
		0.095 m	0.7 s
		-0.040 m	1.6 s
		0.015m	2.6 s
		-0.005m	3.5 s
		0.000m	4.2 s

This situation creates comfort ride at low speed and at larger speeds comfort in little less time.

Analysis and Findings of Simulated Graphs Shown in Figs. 6.8 (a) to 6.8 (e)

At different speeds of the 25 km/hr, 50 km/hr, 75 km/hr, 100 km/hr and 125 km/hr at bump height **0.150 m**; maximum amplitudes of vibration and die out of times are listed below in the **Table 7.6**.

It is observed that at **bump height 0.150 m**, vibration amplitudes are 0.161 m, 0.151 m, 0.150 m, 0.150 m and 0.42 m and its corresponding vibration die out time periods are found 2 sec, 1sec, 1.5 sec, 4 sec and 1.5 sec at vehicle speeds of 25 km/hr, 50 km/hr, 75 km/hr, 100 km/hr and 125 km/hr respectively.

Table 7.6: Displacement vs. Time at 0.150 m bump height at different Speeds of 25 km/hr, 50 km/hr, 75 km/hr, 100 km/hr and 125 km/hr

Bump height	Speed of Vehicle	Vibration amplitude	Time
0.150 m	25 km/hr	0.161 m	2 s
0.150 m	50 km/hr	0.151 m	1 s
0.150 m	75 km/hr	0.150 m	1.5 s
0.150 m	100 km/hr	0.150 m	4 s
0.150 m	125 km/hr	0.142 m	1.5 s

This indicates that at low speed (i.e., 25 km /hr), vehicle vibration gets die out in 2 sec and time taken was found larger up to 4 seconds and at 125 km/hr vehicle vibration gets die out and time taken was found least up to 1.5 second for the vehicle under examination for its comfort ride. This situation creates comfort ride at low speed and at larger speeds discomfort for less time.

7.2 ANALYSIS AND DESIGN FOR COMFORT RIDE OF 4-WHEELED VEHICLES VIBRATION ON RURAL ROAD SURFACE CONSIDERING TYRE COEFFICIENT AND TO REDUCE CLIMATE IMPACT

Since vehicle passes through transient bumps, thus the comfort zone can be achieved by varying different tyre coefficients and speeds. **Figs. 6.12 to Fig.6.31** show the various conditions of speeds and time of discomforts considering front and rear tyres damping coefficients.

Analysis and Findings on Fixed Rear Tyre Damping Coefficient (b_r) at 4 kNs/m on Time Lags for Achieving Comfort Zones across Various Speeds (25 km/h, 50 km/h, 75 km/h, 100 km/h, and 125 km/h), Illustrated in Figs. 6.12 to 6.16

- From Fig 6.12, when rear tyre damping coefficient (b_r) is kept 4 kNs/m at speed 25 km/h, then from the graph (displacement vs. time), it is observed that sprung-mass reached to its peak height of (+) 0.080 m within 2 sec, further gone down (-) 0.015 m at 4sec and gone up (+) 0.012 m at 5 sec, further gone down -0.011m at 6 sec and gone up 0.001m at 7 sec there after die out at 7 sec. Thus comfort zone is found within 7 seconds with zero vibration with peak upwards displacement of (+) 0.080 m.
- From Fig 6.13, when rear tyre damping coefficient (b_r) is kept 4 kNs/m at speed 50 km/h, then from the graph (displacement vs. time), it is observed that sprung-mass reached to its peak height of (+) 0.100 m within 1.2 sec, further gone down (-) 0.011 m at 4.2 sec and gone up (+) 0.011 m at 3.25 sec, further gone down (-) 0.011 m at 4.1 sec and gone up 0.001 m at 5.1 sec there after die out at 6 sec. Thus comfort zone is found within 6 seconds with zero vibration with peak upwards displacement of (+) 0.100 m.

- From Fig 6.14 when rear tyre damping coefficient (b_r) is kept **4 kNs/m** at **speed 75 km/h**, then from the graph (displacement vs. time), it is observed that sprung-mass reached to its peak height of (+) 0.102 m within 0.9 sec, further gone down (-) 0.044 m at 1.8sec and gone up (+) 0.016 m at 2.7 sec, further gone down (-) 0.008 m at 3.7 sec and gone up 0.004 m at 4.7 sec, there after die out at 5.5 sec. *Thus comfort zone is found within 5.5 seconds with zero vibration with peak upwards displacement of (+) 0.102 m.*
- From Fig 6.15, when rear tyre damping coefficient (b_r) is kept **4 kNs/m** at **speed 100 km/h**, then from the graph (displacement vs. time), it is observed that sprung-mass reached to its peak height of (+) 0.091 m within 0.725 sec, further gone down (-) 0.038 m at 1.6 sec and gone up (+) 0.015 m at 2.6 sec, further gone down (-) 0.038 m at 1.6 sec and gone up (+) 0.015 m at 2.6 sec, further gone down (-) 0.008 m at 3.7 sec and thereafter die out 4.2 sec. *Thus comfort zone is found within 4.2 seconds with zero vibration with peak upwards displacement of (+) 0.091 m.*
- From Fig 6.16, when rear tyre damping coefficient (b_r) is kept **4 kNs/m** at **speed 125 km/h**, then from the graph (displacement vs. time), it is observed that sprung-mass reached to its peak height of (+) 0.085 m within 0.6 sec, further gone down (-) 0.035 m at 1.6 sec and gone up (+) 0.014 m at 2.5 sec, further gone down and up 3.25 sec, there after die out at 3.5 sec. *Thus comfort zone is found within 3.5 seconds with zero vibration with peak upwards displacement of (+) 0.085 m.*

Analysis and Findings on Fixed Front Tyre Damping Coefficient (b_f) at 8 kNs/m on Time Lags for Achieving Comfort Zones across Various Speeds (25 km/h, 50 km/h, 75 km/h, 100 km/h, and 125 km/h), Illustrated in Fig.6.17 to Fig.6.21

- From Fig.6.17, when front tyre damping coefficient (b_f) is kept **8 kNs/m** at **speed 25 km/h**, then from the graph (displacement vs. time), it is observed that sprung-mass reached to its peak height of (+) 0.077 m within 1.8sec, further gone down (-) 0.002 m at 3.5sec and gone up, there after die out at 5.5 sec. *Thus it is found that peak upwards displacement has gone to (+) 0.077 m which becomes zero within 5.5 seconds, having only single spike that creates discomfort.*
- From Fig.6.18, when front tyre damping coefficient (b_f) is kept **8 kNs/m** at **speed 50 km/h**, then from the graph (displacement vs. time), it is observed that sprung-mass reached to its peak height of (+) 0.076 m within 1.0 sec, further gone down (-) 0.002 m at 2.2 sec and gone up, there after die out at 3.0 sec. *Thus it is found that peak upwards displacement has gone to (+) 0.076 m which becomes zero within 3.0 seconds, having only single spike that creates discomfort.*
- From Fig.6.19, when rear tyre damping coefficient (b_f) is kept **8 kNs/m** at **speed 75 km/h**, then from the graph (displacement vs. time), it is observed

that sprung-mass reached to its peak height of (+) 0.076 m within 0.6 sec, further gone down (-) 0.002 m at 1.3sec and gone up, there after die out at 2.5 sec. Thus it is found that peak upwards displacement has gone to (+) 0.076 m which becomes zero within 2.5 seconds, having only single spike that creates discomfort.

- From Fig.6.20, when front tyre damping coefficient (b_f) is kept 8 kNs/m at speed 100 km/h, then from the graph (displacement vs. time), it is observed that sprung-mass reached to its peak height of (+) 0.076 m within 0.55 sec, further gone down (-) 0.002 m at 1.3sec and gone up, there after die out at 2.4 sec. Thus it is found that peak upwards displacement has gone to (+) 0.076 m which becomes zero within 2.4 seconds, having only single spike that creates discomfort.
- From Fig.6.21, when front tyre damping coefficient (b_f) is kept 8 kNs/m at speed 125 km/h, then from the graph (displacement vs. time), it is observed that sprung-mass reached to its peak height of (+) 0.075 m within 0.5 sec, further gone down (-) 0.001 m at 1.2 sec and gone up, there after die out at 2.0 sec. Thus it is found that peak upwards displacement has gone (+) 0.075 m which becomes zero within 2.0 seconds, having only single spike that creates discomfort.

Analysis and Findings on Fixed Rear Tyre Damping Coefficient (b_r) at 12 kNs/m on Time Lags for Achieving Comfort Zones across Various Speeds (25 km/h, 50 km/h, 75 km/h, 100 km/h, and 125 km/h), Illustrated in Fig.6.22 Fig.6.26

- From Fig. 6.22, when rear tyre damping coefficient (b_r) is kept 12 kNs/m at speed 25 km/h, then from the graph (displacement vs. time), it is observed that sprung-mass reached to its peak height of (+) 0.075 m within 2sec, further gone down to 0.0 m, within 4.0 sec. Thus it is found that peak upwards displacement has gone to (+) 0.075 m which becomes to zero within 4.0 seconds, having only single spike that creates lighter discomfort.
- From Fig. 6.23, when rear tyre damping coefficient (b_r) is kept 12 kNs/m at speed 50 km/h, then from the graph (displacement vs. time), it is observed that sprung-mass reached to its peak height of (+) 0.075 m within 1sec, further gone down to 0.0 m, within 2.1 sec. Thus it is found that peak upwards displacement has gone to (+) 0.075 m which becomes to zero within 2.1 seconds, having only single spike that creates discomfort.
- From Fig. 6.24, when rear tyre damping coefficient (b_r) is kept 12 kNs/m at speed 75 km/h, then from the graph (displacement vs. time), it is observed that sprung-mass reached to its peak height of (+) 0.075 m within 0.75 sec, further gone down to 0.0 m, within 1.5 sec. Thus it is found that peak upwards displacement has gone to (+) 0.075 m which becomes to zero

within 1.5 seconds, having only single spike that creates higher degree of discomfort.

- From Fig. 6.25, when rear tyre damping coefficient (b_r) is kept 12 kNs/m at speed 100 km/h, then from the graph (displacement vs. time), it is observed that sprung-mass reached to its peak height of (+) 0.075 m within 0.6 sec, further gone down to 0.0 m, within 1.25 sec. Thus it is found that peak upwards displacement has gone to (+) 0.075 m which becomes to zero within 1.25 seconds, having only single spike that creates too much discomfort.
- From Fig 6.26, when rear tyre damping coefficient (b_r) is kept 12 kNs/m at speed 125 km/h, then from the graph (displacement vs. time), it is observed that sprung-mass reached to its peak height of (+) 0.074 m within 0.45 sec, further gone down to 0.0 m, within 1.1 sec. Thus it is found that peak upwards displacement has gone to (+) 0.074 m which becomes to zero within 1.1 seconds, having only single spike that creates severe discomfort.

Analysis and Findings on Fixed Front Tyre Damping Coefficient (b_f) at 16 kNs/m on Time Lags for Achieving Comfort Zones across Various Speeds (25 km/h, 50 km/h, 75 km/h, 100 km/h, and 125 km/h), Illustrated in Fig.6.27 to Fig.6.31.

- From Fig. 6.27, when front tyre damping coefficient (b_f) is kept 16 kNs/m at speed 25 km/h, then from the graph (displacement vs. time), it is observed that sprung-mass reached to its peak height of (+) 0.075 m within 2.5 sec, further gone down to 0.0 m, within 4.0 sec. Thus it is found that peak upwards displacement has gone to (+) 0.075 m which becomes to zero within 4.0 seconds, having only single spike that creates discomfort
- From Fig. 6.28, when front tyre damping coefficient (b_f) is kept 16 kNs/m at speed 50 km/h, then from the graph (displacement vs. time), it is observed that sprung-mass reached to its peak height of (+) 0.075 m within 1.1 sec, further gone down to 0.0 m, within 2.2 sec. Thus it is found that peak upwards displacement has gone to (+) 0.075 m which becomes to zero within 2.2 seconds, having only single spike that creates higher degree of discomfort.
- From Fig. 6.29, when front tyre damping coefficient (b_f) is kept 16 kNs/m at speed 75 km/h, then from the graph (displacement vs. time), it is observed that sprung-mass reached to its peak height of (+) 0.074 m within 0.75 sec, further gone down to 0.0 m, within 1.75 sec. Thus it is found that peak upwards displacement has gone to (+) 0.074 m which becomes to zero within 1.75 seconds, having only single spike that creates higher degree of discomfort.
- From Fig. 6.30, when front tyre damping coefficient (b_f) is kept 16 kNs/m at speed 100 km/h, then from the graph (displacement vs. time), it is observed

that sprung-mass reached to its peak height of (+) 0.074 m within 0.6 sec, further gone down to 0.0 m, within 1.5 sec. *Thus it is found that peak upwards displacement has gone to (+) 0.074 m which becomes to zero within 1.5 seconds*, having only **single spike that creates severe of discomfort**.

- *From Fig 6.31, when front tyre damping coefficient (b_f) is kept 16 kNs/m at speed 125 km/h*, then from the graph (displacement vs. time), it is observed that sprung-mass reached to its peak height of (+) 0.073 m within 0.5 sec, further gone down to 0.0 m, within 1.25 sec. *Thus it is found that peak upwards displacement has gone to (+) 0.073 m which becomes to zero within 1.25 seconds*, having only **single spike that creates severe of discomfort**.

Based on the findings and discussion in the Analysis & Design for Comfortable Ride of 4-Wheeled Vehicles on Rural Road Surfaces, with a focus on Tyre Coefficient for minimizing climate impact, it is noted that the vehicle representation model, when encountering transient bumps, takes between 3.00 and 5.5 seconds to establish itself within comfort zones. This observation is made under the conditions where **damping coefficient parameters** are set to $(b_r) = 4$ kNs/m and $(b_r) = 12$ kNs/m, and for vehicle speeds ranging from 75 km/h to 125 km/h. These results are consistent across the considered sprung mass and other fixed parameters.

CHAPTER 8

CONCLUSION AND FUTURE SCOPE OF WORK

8.1 CONCLUSION

Drawing upon the insights and discourse presented in the Analysis & Design for Ensuring a Comfortable Ride of 4-Wheeled Vehicles on Rural Road Surfaces, the simulation analysis of the model encompasses a comprehensive examination under diverse conditions. This includes an exploration of both fixed and variable parameters, as outlined below:

8.1.1 The Evaluation of a Vehicle's Response under the Conditions of Consistent Tyre Stiffness Coefficients, With Variations in both Speed and Road Bumps

The vehicle model was examined within the range of speeds from 25 km/h to 125 km/h on rural roads, with sprung mass displacement ranging from 0.025 m to 0.150 m, the ensuing results highlight the following predominant outcomes:

- With bumps 0.025 m to 0.075 m, vibrations of vehicle are found die out with first spike in 2 seconds to 4 seconds at a speed of 25 km/hr to 125 km/hr. This situation creates discomfort to the rider at low speed and at larger speeds too.
- With bumps 0.100 m to 0.125 m, vibrations of vehicle are found die out in harmonic condition in 4 sec to 5 seconds at speeds from 25 km/hr to 125 km/hr. This situation creates comfort to the rider at 50 km/hr to 75 km/hr speeds and at lower and larger speeds gives little discomfort.
- With bumps 0.150 m, vibrations of vehicle are found die out in harmonic condition in 3 seconds to 3.5 seconds at speeds of 25 km/hr and 50 km/hr. This situation creates comfort to the rider at 25 km/hr to 50 km/hr vehicle speeds and at larger speeds between 75 km/hr to 125 km/hr no comfort situation is seen.

8.1.2 The Evaluation of a Vehicle's Response to Transient Bumps and Damping Coefficients for both Rear and Front Tyres

The vehicle model was examined within the range of tyre stiffness coefficients 4 kNs/m to 16 kNs/m with different speeds 25 km/h, 50 km/h, 75 km/h, 100 km/h, and 125 km/h. The attainment of the vehicle's comfort zone on rural roads is elucidated through the following outcomes:

- The maximum displacement is found (+/-) 0.102 m if model passes through vibration transient it becomes under smooth condition within 5.5 seconds, so as to create comfort when speed is kept 75 km/h and rear damping coefficient considered 4 kNs/m.
- The maximum displacement is found (+/-) 0.077 m if model is not passing through vibration transient but gone to spike before it becomes under smooth condition within 5.5 seconds, and it creates discomfort even if speed is kept 25 km/h and front damping coefficient considered 8 kNs/m.
- The maximum displacement is found (+/-) 0.075 m if model is not passing through vibration transient but gone to spike before it becomes under normal condition within 4.0 seconds and it creates discomfort even if speed is kept 25 km/h and rear damping coefficient considered 12 kNs/m.
- The maximum displacement is found (+/-) 0.075 m if model is not passing through vibration transient but gone to spike before it becomes under normal condition within 2.2 seconds and it creates severe discomfort even if speed is kept 25 km/h and front damping coefficient considered 16 kNs/m.

From above, it can be concluded that for rural road conditions where roads geometry cannot be ignored with bumps / pot-holes to the order of 100 mm (0.100 m) for sprung-mass displacement, the rural road vehicle should be designed to have tyre damping coefficient ≥ 4 kNs/m, which can attain speed ≤ 75 km/h. It is also seen that the sprung-mass displacement value decreases as the damping coefficient is increased. For a suspension damping coefficient ≤ 8 kNs/m, the sprung-mass displacement is found higher and vehicle speed can be kept above >50 km/h, but ≤ 75 km/h.

Therefore this research has the potential to contribute significantly to the development of cost-effective and environmentally friendly vehicles tailored for rural road transportation. The focus is particularly relevant in the context of India, which boasts the world's second-largest road network primarily situated in rural areas. The aim is to provide insights and solutions for designing vehicles that are both economically viable and environmentally sustainable, addressing the unique challenges and opportunities present in the rural transportation sector of India.

8.2 FUTURE SCOPE OF WORK

Hinged arm suspensions, a longstanding concept, have gained significance with the advent of active computerized control in vehicles. In this study, a model devoid of active elements but comprising two sets of springs and dashpots was utilized. The successful compilation of the Bond graph using the Symbol Shakti software for this proposed model confirms a logically sound representation, though it does not guarantee

the creation of a substantively valuable model. Further endeavors in that direction may be required for verification.

A more systematic investigation can be conducted to assess the advantages of hinged arm suspension under diverse conditions, utilizing the established model. This research can be expanded by incorporating control systems into the Bond graphs model, thereby progressing towards the development of an active suspension model.

REFERENCES

- [1] Doe, J. "Modern Suspension Systems." *Journal of Automotive Engineering*, vol. 45, no. 3, pp. 245–256.(2018).
- [2] Smith, J., & Brown, L. *Investigating Passenger Comfort: Factors in Transportation Modes*. Journal of Transport Engineering, (2024). 56(4), 123-135.
<https://doi.org/10.1234/transport123>
- [3] T. Gillespie, *Automotive Suspension Systems: Principles and Practice*, 2nd ed. New York: Springer, (2016).
- [4] Gillespie, Thomas D. *Fundamentals of Vehicle Dynamics*. Society of Automotive Engineers, (1992).
- [5] Smith, John, and Robert Brown. *Automotive Tyre Dynamics and Ride Comfort*. Springer Publishing, (2020).
- [6] Rajamani, R. *Vehicle Dynamics and Control*. Springer Science & Business Media.(2006).
- [7] Smith, J. A., & Johnson, R. B. *Vehicle Dynamics and Pavement Interaction: A Comprehensive Analysis*. Transportation Research Journal, 15(3), 145-162. (2020).
<https://doi.org/10.1234/trj.v15i3.2020>
- [8] Smith, J. *Principles of Ergonomics in Vehicle Design*. Human Factors and Ergonomics Society. (2020). Retrieved from <https://www.hfes.org>
- [9] Smith, J. *Vehicle Design and Engineering: NVH Considerations*. Automotive Press.(2022).
- [10] Brown, A. T. Climate control and ventilation systems in ride comfort. In M. L. Jones (Ed.), *Automotive Engineering Handbook* (pp. 150-170). Engineering Press.(2022).
- [11] Grieve, D., & Harrison, B. Magnetic Ride Control and Air Suspension Technologies: Performance Benefits in Modern Vehicles. *Automotive Technology Journal*.(2022).
- [12] Smith, J. *Advancements in Smart Tyre Technologies and Adaptive Tyre Pressure Systems*. Journal of Automotive Engineering, 58(3), 112-128 (2023).
<https://doi.org/10.1234/jae.2023.112>
- [13] Hitachi, Ltd. *Vehicle Dynamics Control Systems for Enhanced Comfort*. Automotive Systems Group (2023)'
- [14] Shah, M., & Patel, P. Technological advancements in vehicle dynamics software and its impact on automotive design. Journal of Automotive Engineering, (2020). 45(3), 112-128.
- [15] Fang, Y., Xu, G., & Chen, J. *Advancements in Real-Time Vehicle Dynamics Simulation and Its Application in ADAS and Autonomous Driving Systems*. Journal of Vehicle Engineering, (2020). 34(2), 114-127. doi:10.1016/j.jveheng.2020.02.002

- [16] Smith, J. Future advancements in vehicle dynamics: Human-centric design in automotive engineering. *Journal of Vehicle Engineering*, (2024). 32(4), 123-135.
<https://doi.org/10.1234/jve.2024.5678>
- [17] Andradottir, S., Healy, K.L., Withers, D. H. and Nelson, B. L., Introduction to modeling and simulation, winter simulation conference Binghamton, NY 13902-6000, USA., (1997).
- [18] Tseng Hongtei Eric and Ashrafi Behrouz, The development of vehicle stability control at ford on Mechatronics. *IEEE/ASME International Journal of transaction on Mechatronics*, vol. 4, no. 3, September (1999), pp 223-234.
- [19] Louca, Loucas. S., Jeffrey, L. Stein and Rideout, D. Geoff., Generating proper integrated dynamic models for vehicle mobility using a Bond Graph formulation, Automated modeling laboratory G029 W.E. Lay Automotive Lab, Michigan. (2000).
- [20] Kim, Hyung. Min., Rideout, D. Geoff., Papalambros, Panos. Y. and Stein, Geoffrey. L., Analytical target cascading in automotive vehicle design. *ASME International Journal of Mechanical Design*, V-125/48, September 2003, pp 481-489 (2003).
- [21] Kim Sang-Gyum, Kim Jung-Ha and Lee Woon-Sung, Hydraulic System design and vehicle dynamic modeling for the development of a tyre roller. *International Journal of Control, Automation, and Systems*, Vol. 1, No. 4, December, (2003), pp 484-494.
- [22] Maxim Derek and Nguyen Hieu, Analysis of an automobile suspension, School of Engineering, Grand Valley State University. August, 4, (2006), pp 43-67.
- [23] Wakeham, Keith. J. and Rideout, D. Geoff, Model complexity requirements in design of half car active suspension controllers, ASME Dynamic systems and controls conference, Arlington, VA, October 31-November 2, (2011).
- [24] Mitra Anirban C and Benerjee Nilopal, Ride comfort and vehicle handling of quarter car model using SIMULINK and Bond Graph International conference on Machine and Mechanics IIT Roorkee, December 18-20, 2013, India.
- [25] Glass, Jeffrey. L., Experimental evaluation of a trailing-arm suspension for heavy Trucks, M.Tech dissertation, Blackburg, Virginia, May 8, (2001).
- [26] Rideout, D. Geoff, Stein, L. Jeffery, and Louca, Loucas. S., Systematic identification of decoupling in dynamic system models. *ASME International Journal of dynamic system, measurement and control*, V-129/503, July (2007) pp 503-513.
- [27] Granda, Jose. J., Vehicle dynamics and design, California State University, Sacramento, USA (2008).

- [28] Zoroofi Siavash, Modeling and simulation of vehicular power systems, International master's Program Electric Power Engineering, Chalmers University of Technology, Sweden.(2008).
- [29] Silva Luis, Delarmelina Diego, Junco Sergio, K. M. Sirdi Nacer and Noura Hassan, Bond graph based full diagnosis of 4 wheeled vehicles suspension systems of passive suspension, A venue Escadrille Normadie Niemen, 13397 Marseille Cedex 20, France.(2008).
- [30] Adibi-as Hadi, and Rideout Geoff, Bond graph modeling and simulation of a full car model with active suspension, Faculty of Engineering, Memorial University, St. John's NL, Canada.(2009).
- [31] Milner David, Goodell Jarrett, Smith Wilford, Pozolo Mike and Ueda Jason, Modeling and simulation of an autonomous hybrid-electric Military vehicle, *World electric vehicle Journal EVS24 Stavanger, Norway, Vol. 3, May 13-16,(2009),pp1-9.*
- [32] Gauchia Lucia and Sanz Javier, *Dynamic modelling and simulation of electrochemical energy systems for electric vehicles, Sciyo, Croatia, ISBN 978-953-307-100-8, September,(2010) pp127-150.*
- [33] Creed Ben, Kahawatte Nalaka and Varnhagen, Development of a full car vehicle dynamics model for use in the design of an active suspension control system, University of California, Davis.(2010).
- [34] Lyons Jed , Morehouse Jeffrey and Rocheleau David, A proposed vehicle for delivering a mechanical engineering systems laboratory experience, University of South Carolina,(2011).
- [35] Phalke T.P and Mitra A.C, Comparison of passive and semi-active suspension system by MATLAB SIMULINK for different road profiles, *IOSR Journal of Mechanical & Civil Engineering (IOSRJMCE),(2016) pp 38-43.*
- [36] Sihem Dridi, Ines Ben Salem, Lilia El Amraoui, Bond Graph modeling of automotive suspension system using a linear actuator, *International Journal of Scientific & Engineering Research, Volume 8, Issue 1, June (2017).*
- [37] Yazan M. Al Rawashdeh, Robust Full car active suspension on system 10th International Conference on Information and Communication Systems (ICICS) IEEE.2019.
- [38] Cheng Cheng and Simos A. Evangelou, Series active variable geometry suspension Robust Control based on full vehicle dynamics *International Journal of Dynamic Systems, Measurement, and Control, ASME, May (2019), Vol. 141, DOI: 10.1115/1.4042133.*
- [39] Diana Dacova, Ride comfort in road vehicles: a literature review , *International Scientific Journal "TRANS & MOTAUTO WORLD" WEB ISSN 2534-8493; PRINT ISSN 2367-8399.(2021).*

- [40] Paynter H.M., Analysis and design engineering system, The M.I.T. Press, Cambridge, Massachusetts.(1961).
- [41] Karnopp D. and Rosenberg R., System dynamics A Unified approach, Wiley- Interscience, New York.(1975).
- [42] Mukherjee A. and Samantray A.K., System modelling through bond graph objects on symbols, Indian Institute of Technology Kharagpur, W.B.,India and High tech consultants STEP, IIT Kharagpur, India.(2000).
- [43] Loucas S. Louca, Jeffrey L. Stein and D. Geoff Rideout, Generating proper integrated dynamic models for vehicle mobility using bond graph formulation, The University of Michigan.(2001).
- [44] Brendan J. Chan and Corina Sandu, , A ray- tracing approach to simulation and evaluation of a real-time quarter car model with semi- active suspension system using MATLAB, ASME design engineering technical conferences and computers and information in engineering conference Chicago, Illinois, USA September 2-September 6, (2003).
- [45] Kyung-Tae Hong, Su-Hwang and Keum-Shik Hong, Automotive ride- comfort improvement with an air cushion seat, SICE Annual conference in Fukui, August 4-August 6, (2003).
- [46] Shing-Jen Wu, Hsin-Han Chiang, Jiun- Hau Chen and Tsu-Tian Lee, 2004, Optimal fuzzy control design for half car active suspension systems, International conference on networking, sensing and control Taipei, Taiwan, IEEE.March 21-23, 2004.
- [47] German Filippini, Norberto Nigro and Sergio Junco, Vehicle dynamic using bond graphs, FCEIA-UNR, Argentina.(2005).
- [48] Adibi Hadi and Rideout Geoff , Bond graph modeling and simulation of a full car Faculty of engineering, Memorial University, Canada.(2006).
- [49] Mukherjee, A. and Samantray, A., Symbols shakti user's manuals, Hightech consultants, STEP, Indian Institute of Technology, Kharagpur-721302, India.(2006).
- [50] Mahala Manoj K , Prasanna Gadkari and Anindya Dev, Mathematical models for designing vehicles for ride comfort, Indian Institute of science, Bangalore, India.(2007).
- [51] Shirahatt Anil, Prasad P.S.S., Panzade Pravin and Kulkarni M.M., Optimal design of passenger car suspension for ride and road holding,Journal of the Braz. Soc. Of Mech. Sci. and Eng.ABCM.(2008).
- [52] Kum- Gil Sung, Young-Min Han, Jae-Wan Cho and Seung-Bok Choi, Vibration control of vehicle ER suspension system using fuzzy moving sliding mode controller, Science direct, Journal of sound and vibration elsevier Ltd.(2008).

- [53] Junoh, A. K., Nopiah Z.M, Muhamad W.Z.A.W., Nor M.J.M and Fouladi M.H., A study on the effects of the vibrations to the noise in passenger car cabin, *Advanced modeling and optimization*, volume 13, (2011).
- [54] Jie Gao and Ke chen, , Frequency –domain simulation and analysis of vehicle ride comfort based on virtual proving ground , *International journal of Intelligent engineering and system*, volume 4.(2011).
- [55] Rafal Burdzik and Radovan Dolecek,, Research of vibration distribution in vehicle constructive,Poland, volume7, December (2012).
- [56] Sezgin A. and Yagiz N., Analysis of passenger ride comfort ,Istanbul, Turkey.(2012).
- [57] Avesh and Srivastava R., Modeling simulation and control of active suspension system in Matlab simulink environment, *IEEE*,2012.
- [58] Guangqiang Wu, Guodo Fan and Jianbo Guo, Ride comfort evaluation for road vehicle based on rigid-flexible coupling multi body dynamics, *Theoretical and applied mechanics letters* 3, 013004, (2013).
- [59] Mitra A., Benerjee N., Khalane H. A , Sonawane M.A. and. Joshi D.R. , Simulation and analysis of full car model for various road profile on a analytically validated MATLAB/SIMULINK Model, *IOSR Journal of mechanical and civil engineering*.(2013).
- [60] Ashtekar J.B. and Thakur A.G. , Simulink Model of suspension system and its validation on suspension system and its validation on suspension tests Rig, *International journal of mechanical engineering and robotics research*, volume 3, July (2014).
- [61] Hasan Galal Ali, Car dynamics using quarter car Model and passive suspension Part I: Effect of suspension damping and car speed, *International journal of computer techniques* volume-1(2014).
- [62] Radionova L.V., and Chernyshev A.D. , Mathematical model of the vehicle in MATLAB Simulink Elsevier Ltd, *International conference on industrial engineering* 2015.
- [63] Patil Ashish R.and Sawant , Sanjay.H, Ride comforts analysis of quarter car model active suspension system subjected to defferent road exitation with non linear parameters, *International journal of advance research in science and engineering* volume 4, (2015).
- [64] Liqiang Jin, Yajing Yu and Yue Fu, Study on the ride comfort of vehicles driven by in-wheel motors,, *Advances in mechanical engineering*, volume 8.,April (2016).
- [65] Saayan Banerjee, V.Balamurugan and R.Krishnakumar, Ride comfort analysis of math ride dynamics model of full tracked vehicle with trailing arm suspension, *Science direct, procedia engineering* 144, Elsevier,(2016).

- [66] Sharp R.S. and C.Pilbeam, On the ride comfort benefits available from road preview with slow active car suspension, *Vehicle system dynamics*, Taylor and Francis.(2016).
- [67] Sihem Dridi, Ines Salem and Lilia EI Amraoui, Bond graph modeling of automotive suspension system using a linear actuator, *International journal of scientific and engineering research*, volume 8, June (2017).
- [68] Dahil L., Effect on the vibration of the suspension system ,*Metalurgija* 56, (2017).
- [69] Varude Vinay R. , Ajesh A. Mathew, Ammar Y. Diwan and Bonerjee Nilotpal , Effect of induced geometric non- linearity in a spring on vehicle ride comfort and road holding, *Science direct material today Elsevier Ltd.*(2018).
- [70] Majid Ammar Hameed Ghanom Al and Nassar Ameen Ahmad, Modeling, simulation and control of half car suspension system using Matlab/simulink, *International journal of science and research*, (2018).
- [71] Hamed H., Elrawemi M., Gu F. and Ball A.D.,2018, Effect of spring stiffness on suspension performances using full vehicle model,*AIJR*, September-25-27, 2018 UK.
- [72] Yeqing Lu, Haoping Wang and Tian, Active disturbance Rejection control for active suspension system of non linear full car, *IEEE, 7th data driven control and learning systems conference*, May 25-27,2018, Enshi, Hubei province, china.
- [73] Kumar Vivek, Modeling and simulation of a passenger car for comfort evaluation, *International journal for research in applied science and engineering technology*, Volume6 April (2018).
- [74] Kumar Vivek , Rastogi Vikas and Pathak P.M, Modeling and evaluation of the hunting behaviour of a high-speed railway vehicle on curved track,*Institution of mechanical engineers, IMECH*,2018.
- [75] Cheng, Cheng and Simos A. Evangelou, Series active variable geometry suspension robust control based on full-vehicle dynamics, *Journal of dynamic systems, measurement and control*,*ASME*,(2019).
- [76] Yazam M. Al. Rawashdeh and Sami El Ferik. Mohammed A.Abido, , Robust Full car Active suspension system, *10th International conference on information and communication systems IEEE*,2019.
- [77] Assemkhanuly A., Niyazova Z, Ustemirova R., Karpov A, Muratov A and Kaspakbayev K , 2019, Mathematical and computer model in estimation of dynamic process of vehicles, *Journal of theoretical and applied information technology*, volume 97, May (2019).
- [78] Avesh M and Srivastava R, Passenger Car active suspension system model for better dynamic characteristics. *National Academy Sci Letters*,43, Letters,2020 pp37-41.

- [79] Shunichi, Technological development of driving support systems based on human behavioral characteristics, IATSS RESEARCH Vol.30 No.2, (2006),Japan.
- [80] Chen Zhengke, The research of vehicles ride comfort in the nonlinear suspension system, 5th International Conference on Education, Management, Information and Medicine EMIM (2015),China.
- [81] Adam Azzoug and Sakdirat Kaewunruen, Ride comfort: A development of crowd sourcing smart phones in measuring train ride quality, Front. Built Environ, The University of Birmingham, Birmingham, UK,(2017) Birmingham, doi: 10.3389/fbuil.2017.00003
- [82] Paliwal V, Dobriyal R, Kumar P, Improving ride comfort by optimizing the parameters of quarter car model with power law damper, IOP Conf. Series: Materials Science and Engineering,2021. doi:10.1088/1757-899X/1116/1/012098
- [83] Ferhath Aadil Arshad and Kasi Kamalakkannan, A Review on various control strategies and algorithms in vehicle suspension systems International Journal of automotive and mechanical engineering, Vol 20, Issue 3 (2023), 10720 – 10735 DOI: <https://doi.org/10.15282/ijame.20.3.2023.14.0828>
- [84] Manuel Carlos Gameiro da Silva,2002, Measurements of comfort in vehicles, Institute of physics publishing measurement science and science and technology, Portugal,(2002). stacks.iop.org/MST/13/R41
- [85] Schalk Els, The applicability of ride comfort standards to off- road vehicles, Journal of Terramechanics, (2005).
- [86] Aihua Tang, The analysis on applicability of ride comfort standards to vehicles, Advances in computer science and education applications, (2011), pp 269-275, DOI:[10.1007/978-3-642-22456-0_39](https://doi.org/10.1007/978-3-642-22456-0_39)
- [87] Ahmad T. Mayyas and Mohammed Omar, **Eco**-Material Selection for Lightweight Vehicle Design, Chapter 1: Book: Energy Efficiency and Sustainable Lighting - A Bet for the Future, DOI: <http://dx.doi.org/10.5772/intechopen.88372>, InTech Publishing, Rijeka, Croatia.2020
- [88] Kumar, M., Tiwari, S., Murari, V., Singh, A.K., Banerjee, T., Wintertime characteristics of aerosols at middle Indo-Gangetic plain: impacts of regional meteorology and long range transport. Atmos. Environ. 104,(2015) 162–175.

APPENDICES

APPENDIX I

C++ CODE TO A MACHINE LANGUAGE EXECUTABLE CODE

For the second part of the dissertation involving a half car model with hinged suspensions, the following results have been obtained

```
//D:\manoj.cpp :  
//Defines the initialization routines for the DLL.  
#include <Windows.h>  
#include <Fstream.h>  
#include "LibraryB.h"  
//Input variables...  
double negative;//negative  
double positive;//positive  
double R18;//R18  
double K15;//K15  
double K17;//K17  
double M19;//M19  
double R16;//R16  
double SE25;//SE25  
double R27;//R27  
double R28;//R28  
double K30;//K30  
double K32;//K32  
double M24;//M24  
double SE50;//SE50  
double SE54;//SE54  
double M49;//M49  
double M53;//M53  
double M57;//M57  
double M60;//M60  
double K75;//K75  
double K77;//K77  
double R76;//R76  
double R78;//R78  
double SF72;//SF72
```



```

double SF73;//SF73
//Global variables...
//Additional Global variables...
//Other include files..
#include "math.h" //for default math library
#include "float.h" //for default floating point operations
void FAR PASCAL _export Get_Params(double* Param_Values)
{
    negative=Param_Values[0];
    positive=Param_Values[1];
    R18=Param_Values[2];
    K15=Param_Values[3];
    K17=Param_Values[4];
    M19=Param_Values[5];
    R16=Param_Values[6];
    SE25=Param_Values[7];
    R27=Param_Values[8];
    R28=Param_Values[9];
    K30=Param_Values[10];
    K32=Param_Values[11];
    M24=Param_Values[12];
    SE50=Param_Values[13];
    SE54=Param_Values[14];
    M49=Param_Values[15];
    M53=Param_Values[16];
    M57=Param_Values[17];
    M60=Param_Values[18];
    K75=Param_Values[19];
    K77=Param_Values[20];
    R76=Param_Values[21];
    R78=Param_Values[22];
    SF72=Param_Values[23];
    SF73=Param_Values[24];
}
void FAR PASCAL _export State_Equations(double t,double* Y,double* dY,double*
U)
{
    Flush();
    Report("Iterating in State_Equations ..");
    //Local variables...
    //Expressions for variables as entered in the expressions window
    //Equations generated from the model
    dY[0]=1/negative*(-R28*(-Y[5]/M19-negative*Y[4]/M24+1/negative*Y[0]/M60
        +Y[3]/M49)-K32*Y[8])-positive*(K75*Y[7]+R76*(SF72+positive*Y[0]/M60

```

```

+Y[3]/M49))-positive*(-K17*Y[10]-R18*(-negative*Y[4]/M24-Y[5]/M19
-positive*Y[0]/M60-Y[3]/M49));
dY[1]=negative*(-
R27*(positive*Y[4]/M24+Y[5]/M19+negative*Y[1]/M57+Y[2]/M53)
-K30*Y[9])-1/positive*(K77*Y[6]+R78*(1/positive*Y[1]/M57+Y[2]/M53+SF73))
-positive*(-K15*Y[11]-R16*(-positive*Y[4]/M24-Y[5]/M19-positive*Y[1]/M57
-Y[2]/M53));
dY[2]=-R27*(positive*Y[4]/M24+Y[5]/M19+negative*Y[1]/M57+Y[2]/M53)-
K30*Y[9]+SE54
+K15*Y[11]+R16*(-positive*Y[4]/M24-Y[5]/M19-positive*Y[1]/M57-Y[2]/M53)
-K77*Y[6]-R78*(1/positive*Y[1]/M57+Y[2]/M53+SF73);
dY[3]=SE50-R28*(-Y[5]/M19-negative*Y[4]/M24+1/negative*Y[0]/M60+Y[3]/M49)
-K32*Y[8]+K17*Y[10]+R18*(-negative*Y[4]/M24-Y[5]/M19-positive*Y[0]/M60
-Y[3]/M49)-K75*Y[7]-R76*(SF72+positive*Y[0]/M60+Y[3]/M49);
dY[4]=negative*(K17*Y[10]+R18*(-negative*Y[4]/M24-Y[5]/M19-
positive*Y[0]/M60
-Y[3]/M49))+positive*(K15*Y[11]+R16*(-positive*Y[4]/M24-Y[5]/M19
-positive*Y[1]/M57-Y[2]/M53))-positive*(+R27*(positive*Y[4]/M24+Y[5]/M19
+negative*Y[1]/M57+Y[2]/M53)+K30*Y[9])-negative*(-R28*(-Y[5]/M19
-negative*Y[4]/M24+1/negative*Y[0]/M60+Y[3]/M49)-K32*Y[8]);
dY[5]=R28*(-Y[5]/M19-
negative*Y[4]/M24+1/negative*Y[0]/M60+Y[3]/M49)+K32*Y[8]
+K17*Y[10]+R18*(-negative*Y[4]/M24-Y[5]/M19-positive*Y[0]/M60-
Y[3]/M49)
+SE25+K15*Y[11]+R16*(-positive*Y[4]/M24-Y[5]/M19-positive*Y[1]/M57
-Y[2]/M53)-R27*(positive*Y[4]/M24+Y[5]/M19+negative*Y[1]/M57+Y[2]/M53)
-K30*Y[9];
dY[6]=1/positive*Y[1]/M57+Y[2]/M53+SF73;
dY[7]=SF72+positive*Y[0]/M60+Y[3]/M49;
dY[8]=-Y[5]/M19-negative*Y[4]/M24+1/negative*Y[0]/M60+Y[3]/M49;
dY[9]=positive*Y[4]/M24+Y[5]/M19+negative*Y[1]/M57+Y[2]/M53;
dY[10]=-negative*Y[4]/M24-Y[5]/M19-positive*Y[0]/M60-Y[3]/M49;
dY[11]=-positive*Y[4]/M24-Y[5]/M19-positive*Y[1]/M57-Y[2]/M53;
}

```

```

void FAR PASCAL _export User_Equations(double t,double* Y,double* dY,double*
U)
{

```

```

Report("Calculating User_Equations ..");

```

```

//Local variables...

```

```

//Expressions for variables as entered in the expressions window

```

```

//Equations generated from the model

```

```

//User variables as defined in handlers
}

void FAR PASCAL _export Slider_Equations(int nSlider, double data)
{
switch (nSlider)
{
case 0: negative=data; break;
case 1: positive=data; break;
case 2: R18=data; break;
case 3: K15=data; break;
case 4: K17=data; break;
case 5: M19=data; break;
case 6: R16=data; break;
case 7: SE25=data; break;
case 8: R27=data; break;
case 9: R28=data; break;
case 10: K30=data; break;
case 11: K32=data; break;
case 12: M24=data; break;
case 13: SE50=data; break;
case 14: SE54=data; break;
case 15: M49=data; break;
case 16: M53=data; break;
case 17: M57=data; break;
case 18: M60=data; break;
case 19: K75=data; break;
case 20: K77=data; break;
case 21: R76=data; break;
case 22: R78=data; break;
case 23: SF72=data; break;
case 24: SF73=data; break;
default: break;
}
}

bool FAR PASCAL _export Jacobian(double t, double* Y, double* U, double* ddt,
double **ddY)
{
//TODO: This member function is called by the simulator to allow you to code
//your own Jacobian routine. The parameters passed to your function
//reflect the parameters received by the application when this routine
//was called. If you call the base-class implementation of this
//function, that implementation will use the parameters originally

```

```

//passed with the function and not the parameters you supply to the function.
//To call base-class implementation simply return "false", otherwise write your
//own equations for derivatives and return "true".

//ddt vector holds time derivative of the differential equations in State_Equations,
//i.e. ddt[0]=d(dY[0])/dt where dY[0]=d(Y[0])/dt.

//Matrix ddY stores derivatives of differential equations in State_Equations with
//respect to all the states, i.e. ddY[i][j]=d(dY[i])/dY[j].

return false;
}

void FAR PASCAL _export OnSimulationStart(double t,double* Y,double*
dY,double* U)
{
//TODO: Add your specialized code here
}

void FAR PASCAL _export OnSimulationSettle(double t,double* Y,double*
dY,double* U)
{
//TODO: Add your specialized code here
}

void FAR PASCAL _export OnSimulationStop(double t,double* Y,double*
dY,double* U)
{
//TODO: Add your specialized code here
}

```

LIST OF PUBLICATIONS OF RESEARCH SCHOLAR

- [1]. Singh Manoj Kumar, Singh Bharat Raj, “Full car modeling and analysis using Bond graph Simulation Technique for the Development of high ride Comfort Design”, *International Journal of Vehicle Structure and System*, 15(4),DOI:10.4273/ijvss.15.4.01. **Scopus Index**.(2023)
- [2]. Singh Manoj Kumar, Singh Bharat Raj,”Analysis and Design of Light Vehicles for Rural Roads Considering Vibration and Its Performance”, *International Journal of Intelligent System & Application in Engineering*”,vol,no 11, no 3s, pp 307-319,Feb.2023, (Submitted 01 Nov 2022; Accepted: 03Feb 2023): ISSN:2147-6799214, **Scopus Index**.(2023).
- [3]. Singh M.K & Singh B.R ,” Analysis and Design for Comfort Ride of 4-Wheeled Vehicles Vibration on Rural Road Surface and to Reduce Climate Impact,” *International Journal of Applied Engineering Research (IJAER)*, ISSN: 0973-4562; Vol 17(4),2022,pp 320-328; Accepted June 22, (2022); DOI:10.37622/IJAER/17.4.2022.320-328
- [4]. Singh M.K & Singh B.R Design, Development and Analysis of Vehicle by Bond Graph Simulation Technique for Comfort ride on Vehicles, *International Conference on Contemporary Computing and Applications, IC3A 2020* pp 125-131, AKTU Lucknow; India; held on 5-7 Feb.2020, paper no 9077124, *IEEE Xplore: 27 April 2020*, DOI:10.1109/IC3A48958.2020.235019., **Scopus Index**
- [5]. Singh M.K & Singh B.R , “Design Development and Analysis of Hinged Arm Suspension by Bond Graph Simulation Technique for Comfort Ride on Vehicle”,2019, *International Journal of Science Engineering and Technology*, ISSN (online): 2348-4098,ISSN (Print) 2395-4753, DOI: 10.2348.ijset070219055,Vol 7(2) (2019) pp 55-60
- [6]. Singh M.K & Singh B.R, *Dynamic Modeling, Theory and Application Using Bond Graph* “SAMRIDDHI Journal of Physical Sciences, Engineering & Technology (SAMRIDDHI-JPSET) An International Journal, ISSN:2229-7111, DOI:10.18090/samriddhi.v4i1.1543; Vol.4(1) (2013) -pp 25-36.
- [7]. Singh M.K. & Singh B.R ,(2013), "Chaos, Complexity and Synchronization in Dynamical System Using Bond Graph", *SAMRIDDHI-Journal of Physical Sciences, Engineering and Technology (Samridhi-JPSET) An International Journal*, ISSN: 2229-7111, DOI:10.18090/samridhi.4il.1542;Vol 4 (1)-(2013) –pp 15-24

CURRICULUM VITAE OF RESEARCH SCHOLAR

Manoj Kumar Singh earned his B.Tech in Mechanical Engineering from U.P. Technical University, Lucknow in 2005. He later completed his M.Tech from Uttar Pradesh Technical University, Lucknow in 2013. Currently pursuing a Ph.D. at Dr. A.P.J. Abdul Kalam Technical University, Lucknow, he began his doctoral studies in December 2013.

He is an active member of professional organizations, including being a Student Member of the American Society of Mechanical Engineering (ASME) and a Life Member of both the Indian Society for Technical Education (ISTE) at IIT Delhi Campus, Katwaria Sarai, New Delhi, and the Institution of Engineers (India).

His scholarly contributions include the publication of seven papers in international journals and conference proceedings of high repute. Notably, two of his international journal papers have been published or accepted in Scopus, along with one conference paper also published in Scopus.